

HUMAN ERROR

Gabor Oplatka

Zurich/Switzerland

10. OITAF Congress
RIO DE JANEIRO 2011

HUMAN ERROR

- ERROR IN THINKING

NEGLIGENCE

- SLOPPY JOB
- CARELESSNESS









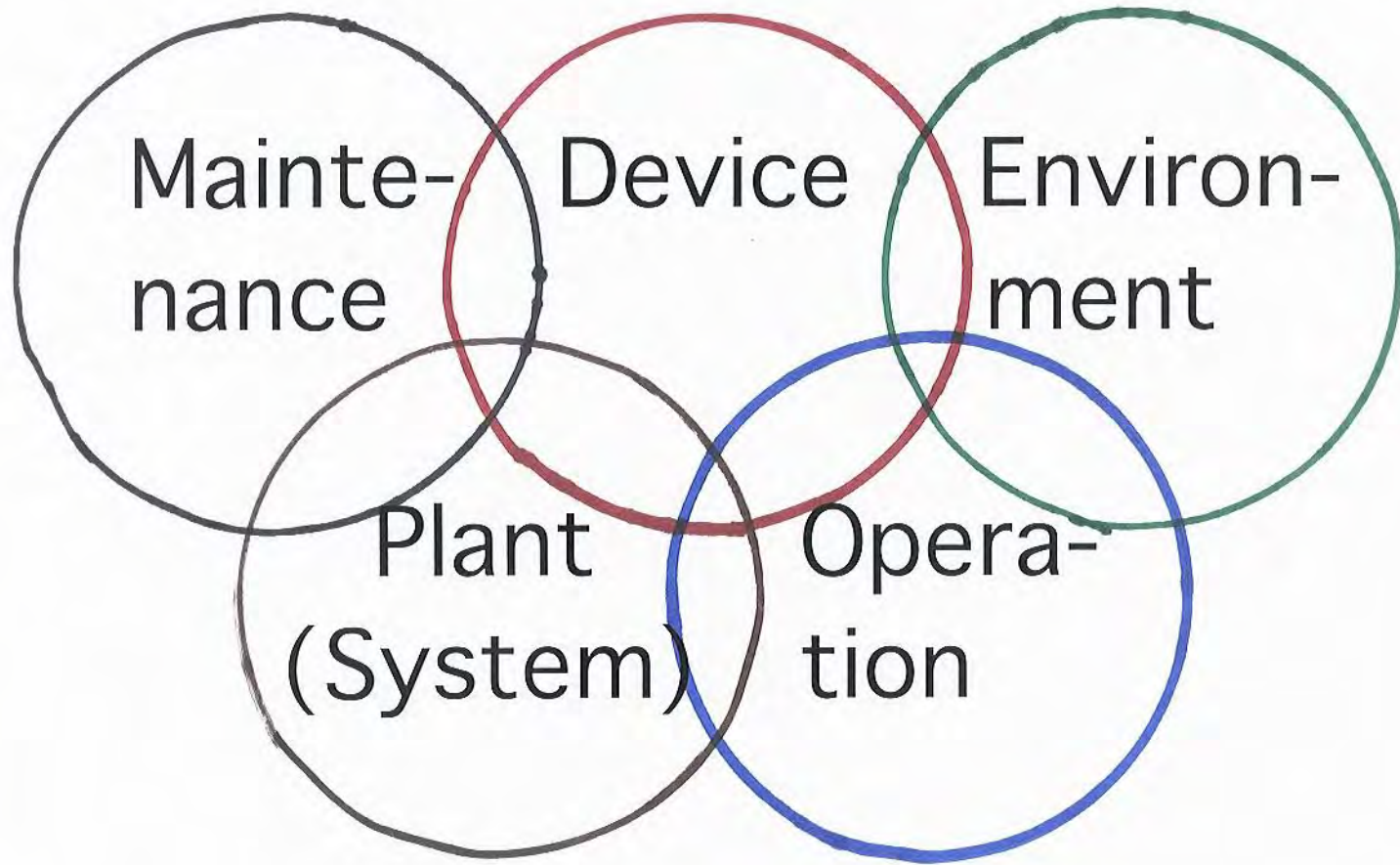

Mainte-
nance

Device

Environ-
ment

Plant
(System)

Opera-
tion



W: Müller





"... and we can save 700 lira by not taking soil tests."





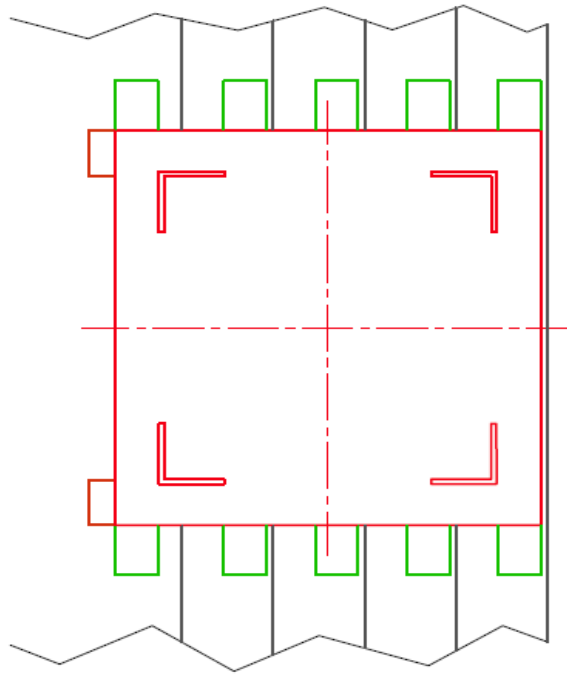
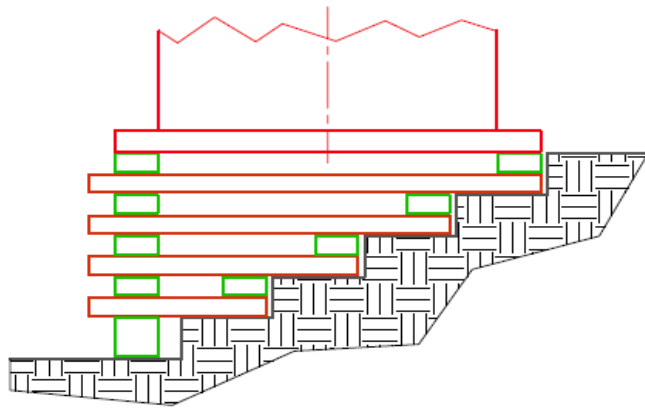

HUMAN ERROR

TO FORGET, OVERLOOK
ONE OF THE FACTORS

HUMAN ERROR
TO FORGET, OVERLOOK
ONE OF THE FACTORS

$$F_x = 0$$

$$M_x = 0$$

$$F_y = 0$$

$$M_y = 0$$

$$F_z = 0$$

$$M_z = 0$$

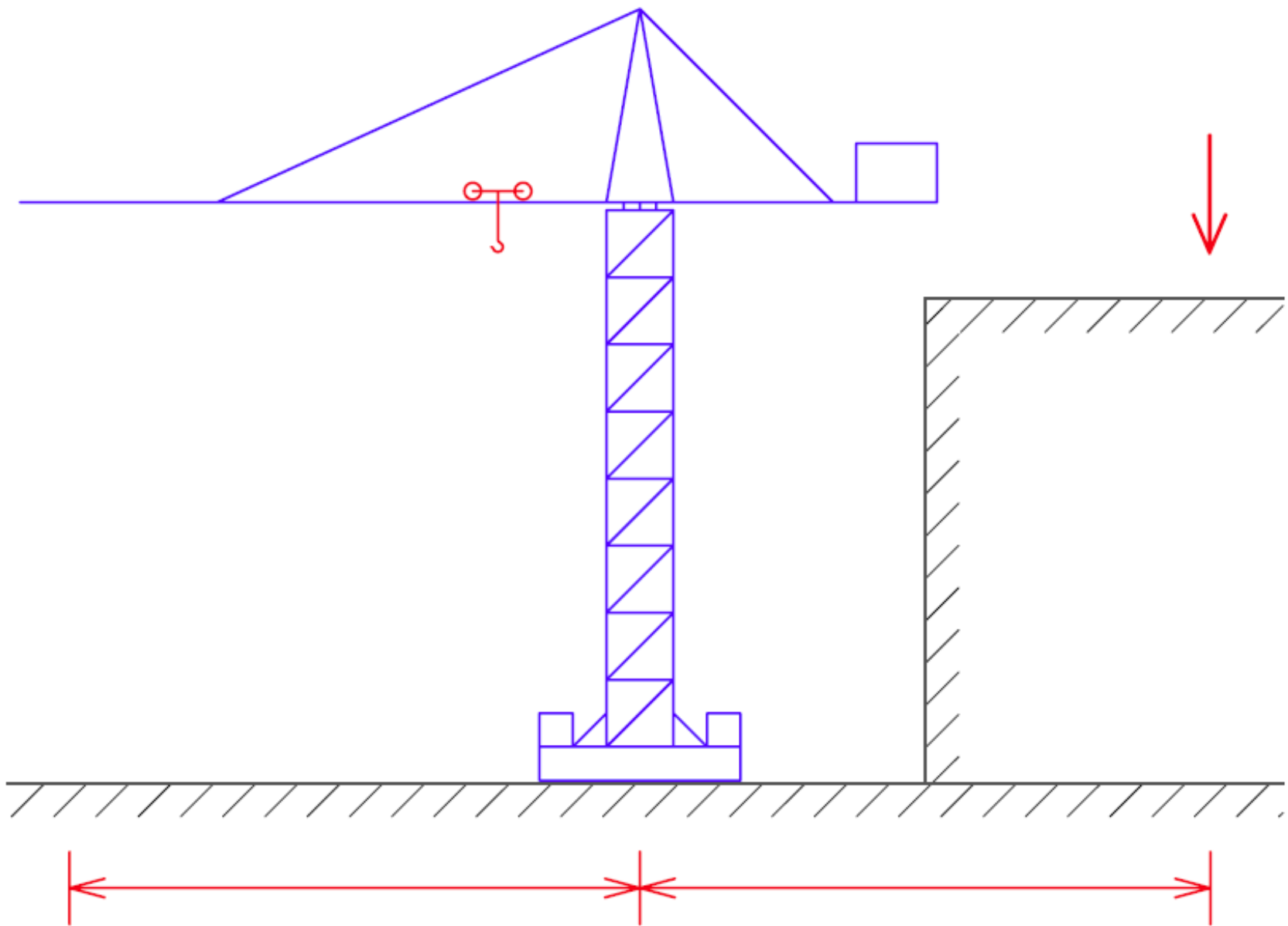

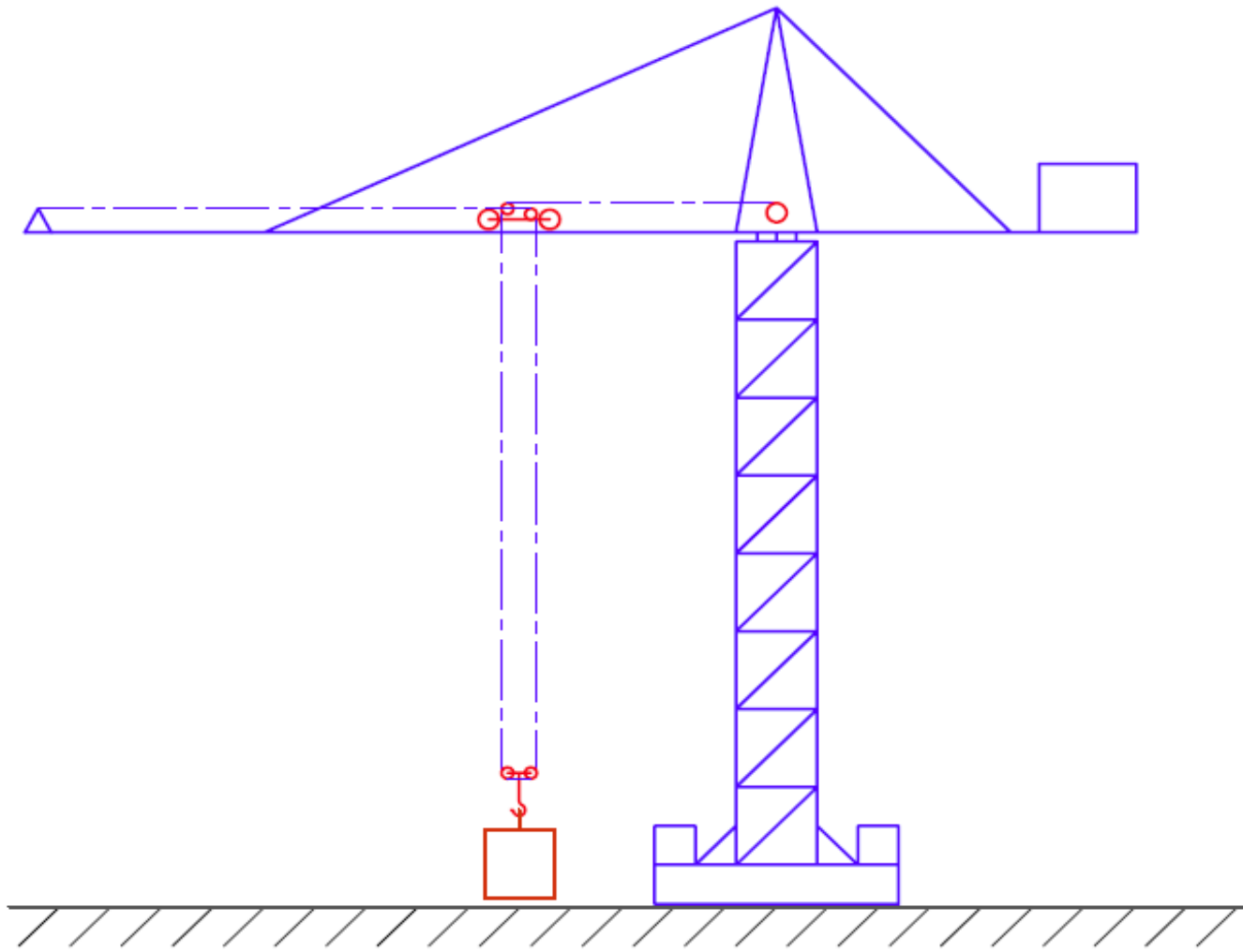

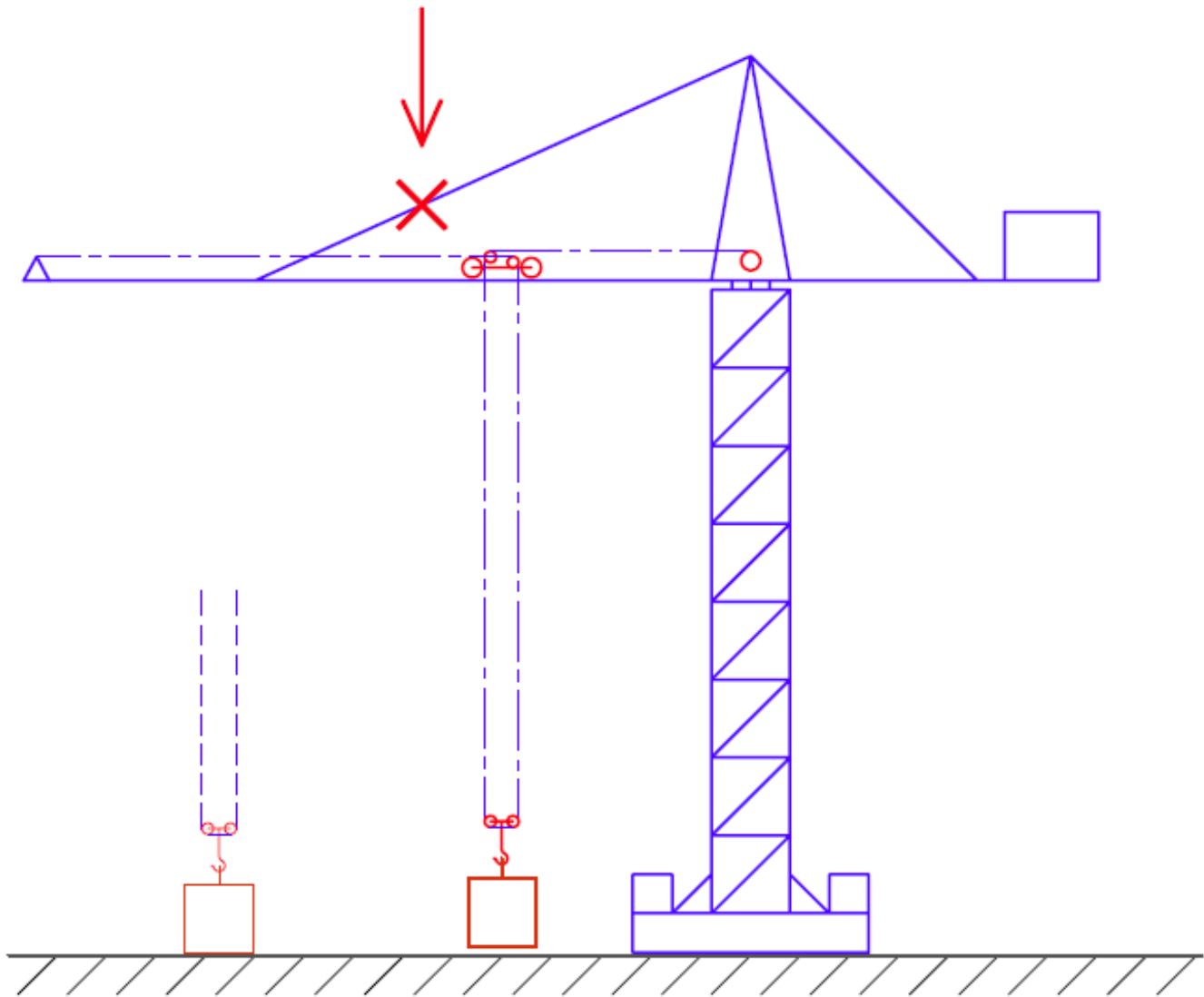

HUMAN ERROR

USING WRONG CRITERIA

TAKE YOUR KEY
DOOR IS ALWAYS LOCKED
DO NOT PRESS BUTTON
WHEN LEAVING ROOM
FOR COMPLETE PRIVACY WHEN
IN ROOM-PRESS BUTTON



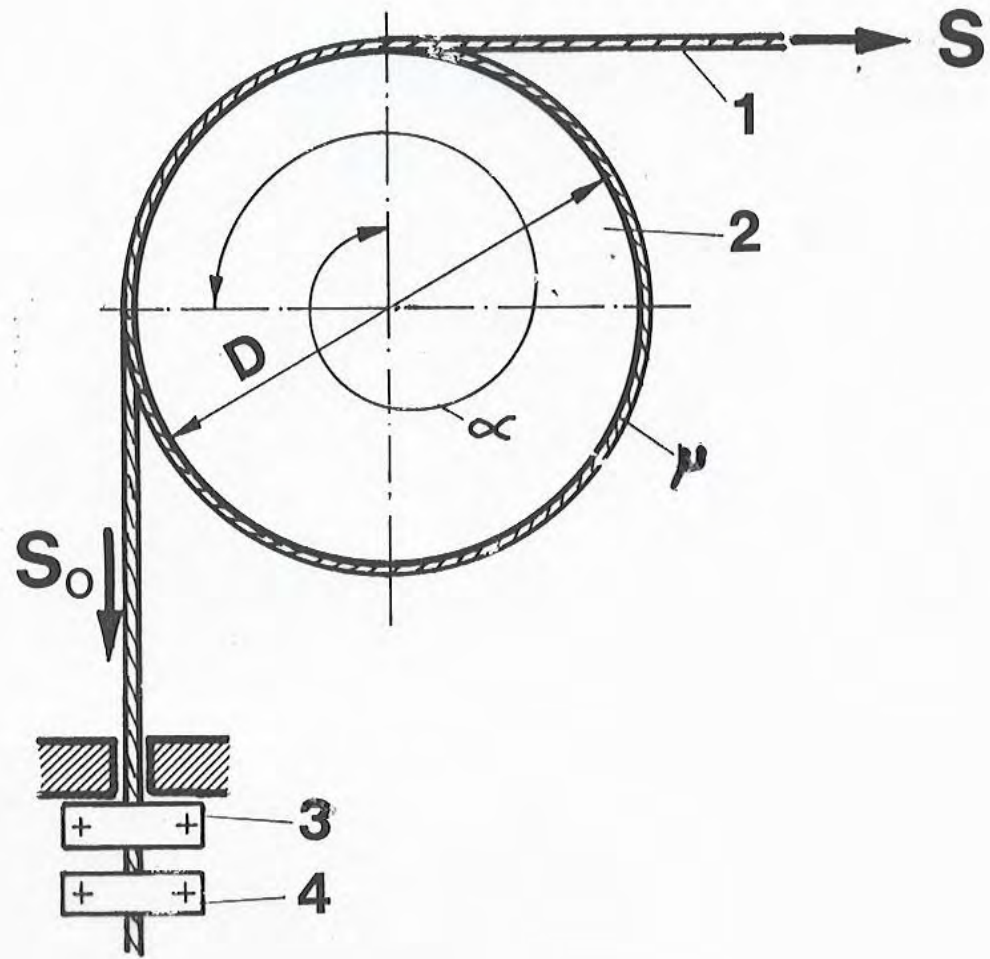

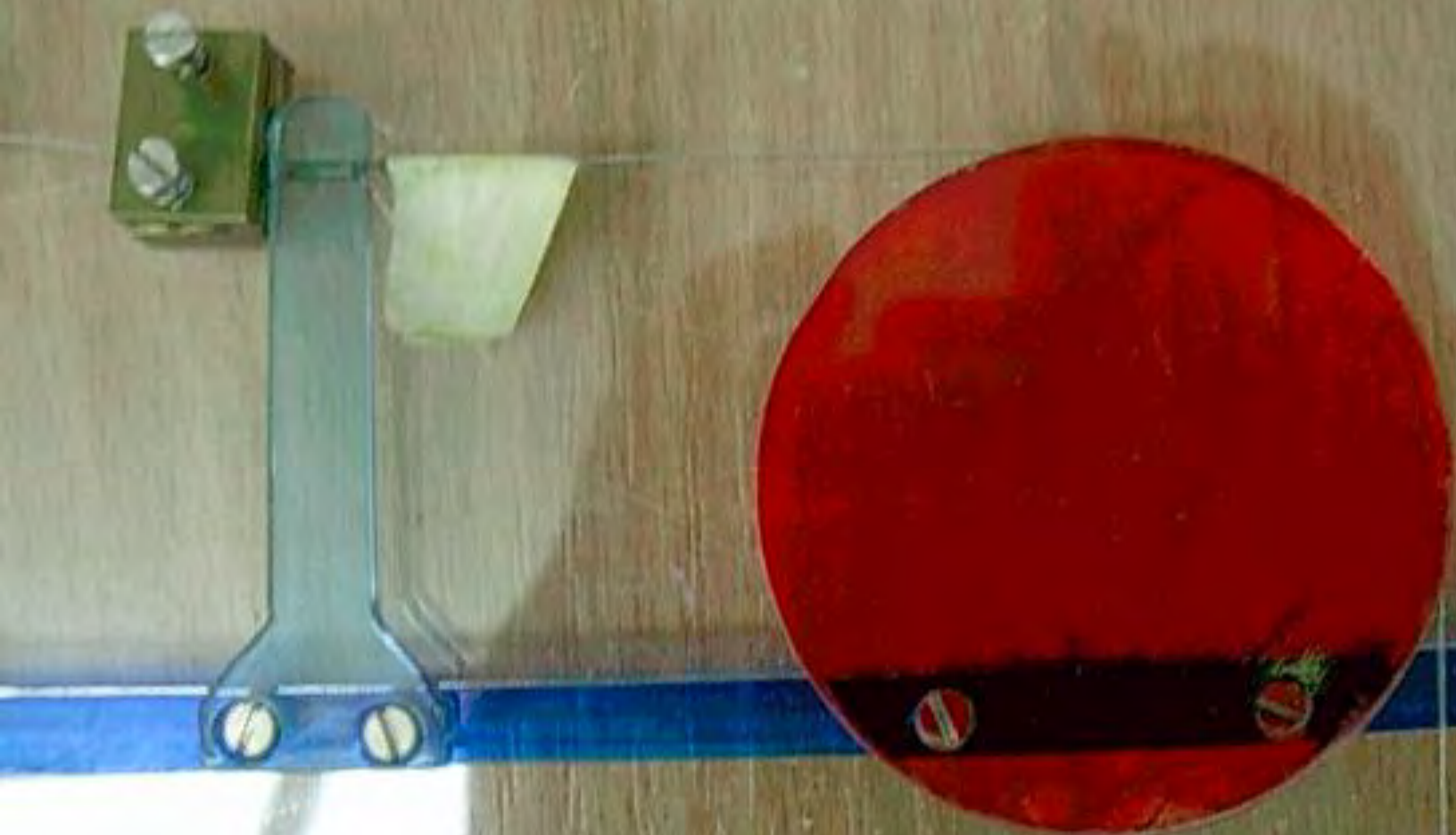

HUMAN ERROR

THE WAY THE EQUIPMENT
FUNCTIONS HAS NOT BEEN
THOUGHT OUT PROPERLY

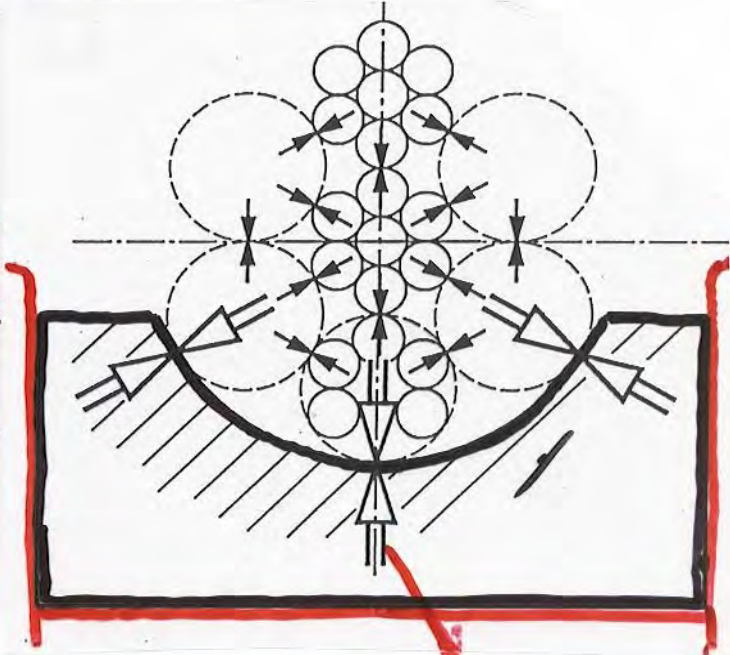
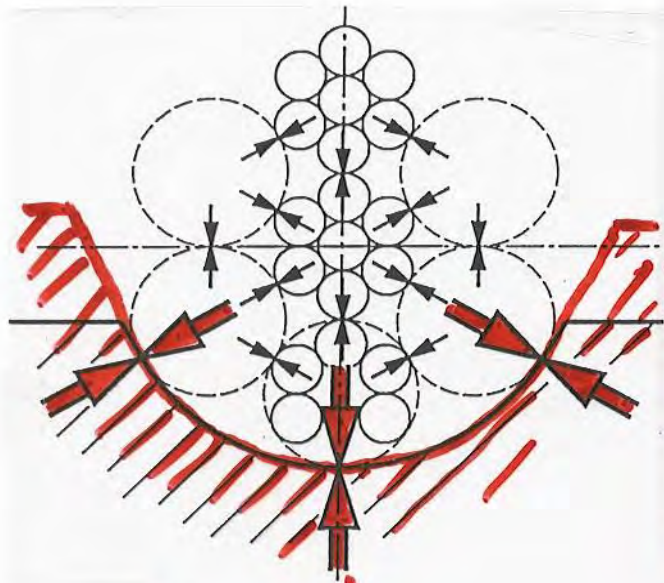

WIRE BREAKS

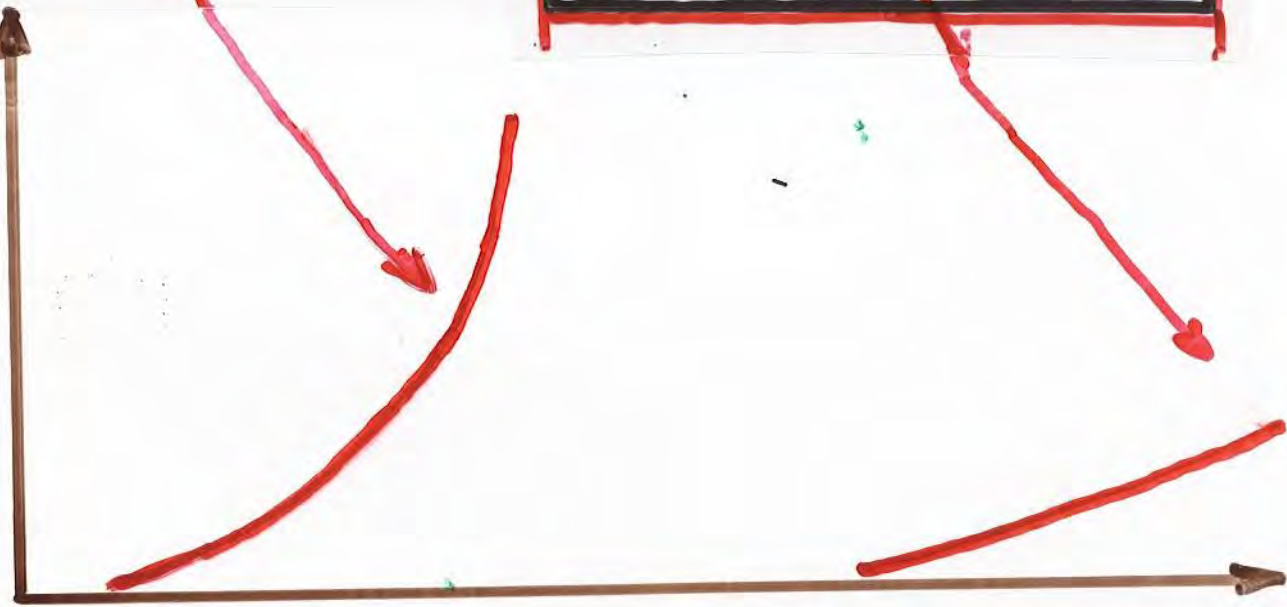

SERVICE TIME

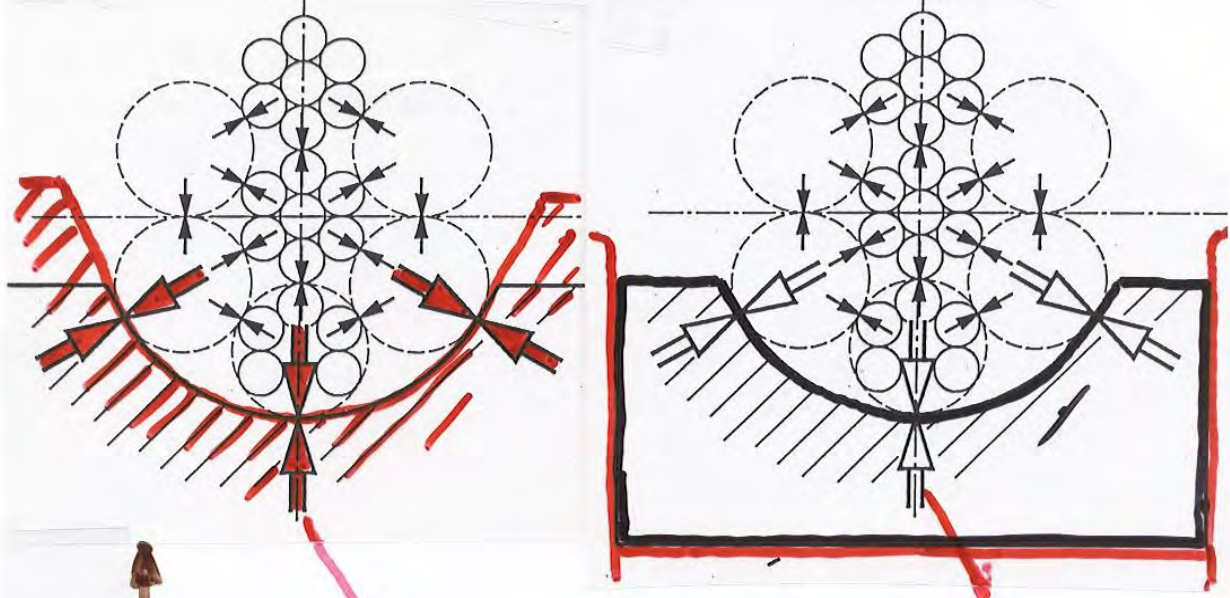

WIRE BREAKS

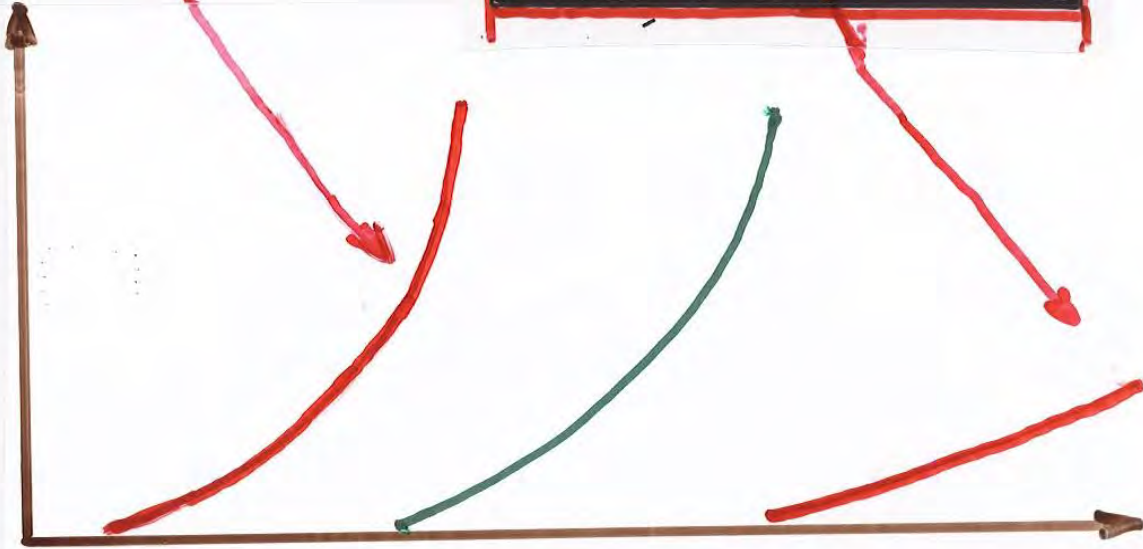

SERVICE TIME

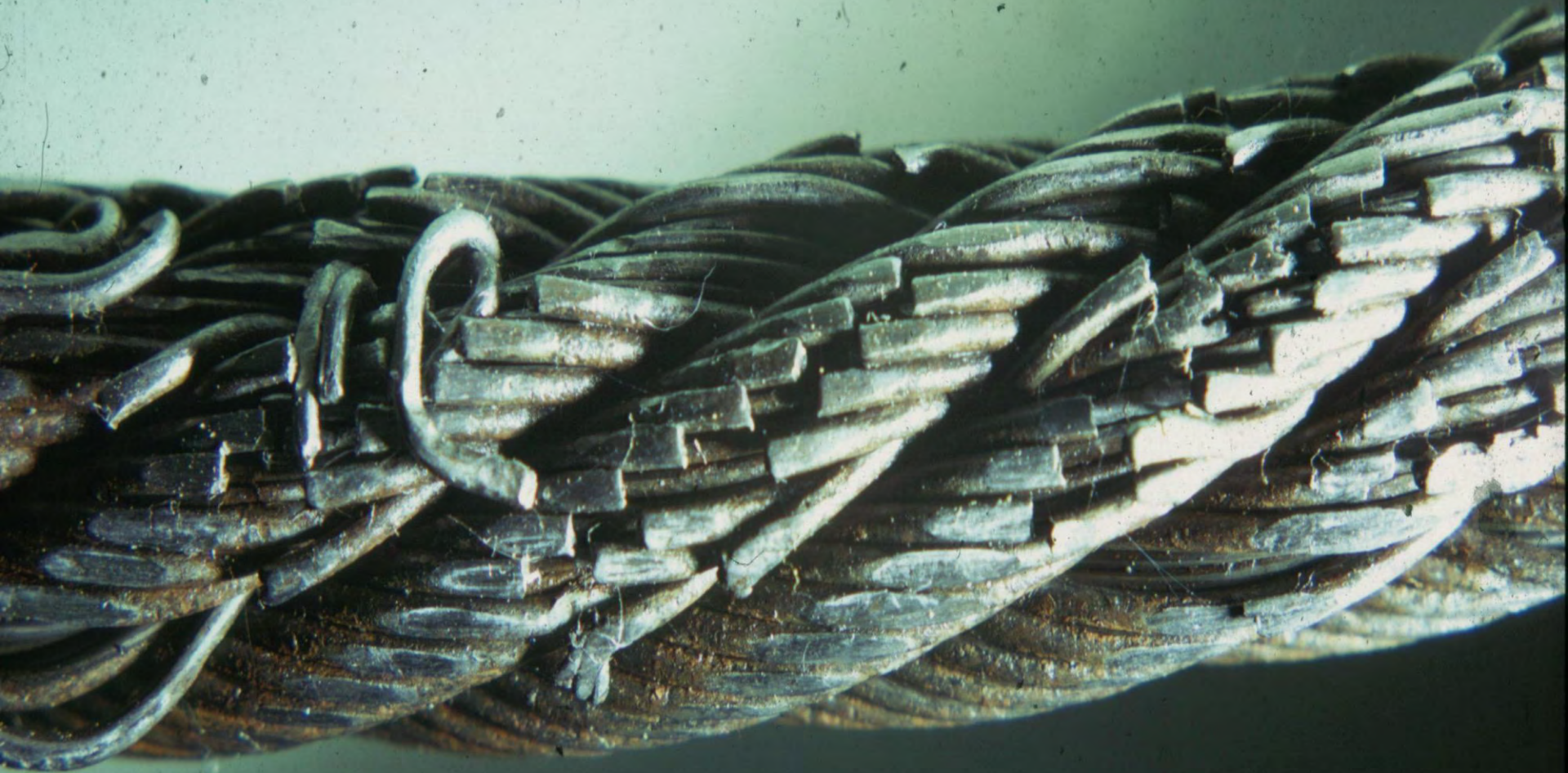



HUMAN ERROR

"IMPROVE" ONE DETAIL
WITHOUT THINKING OF
ALL ITS CONSEQUENCES

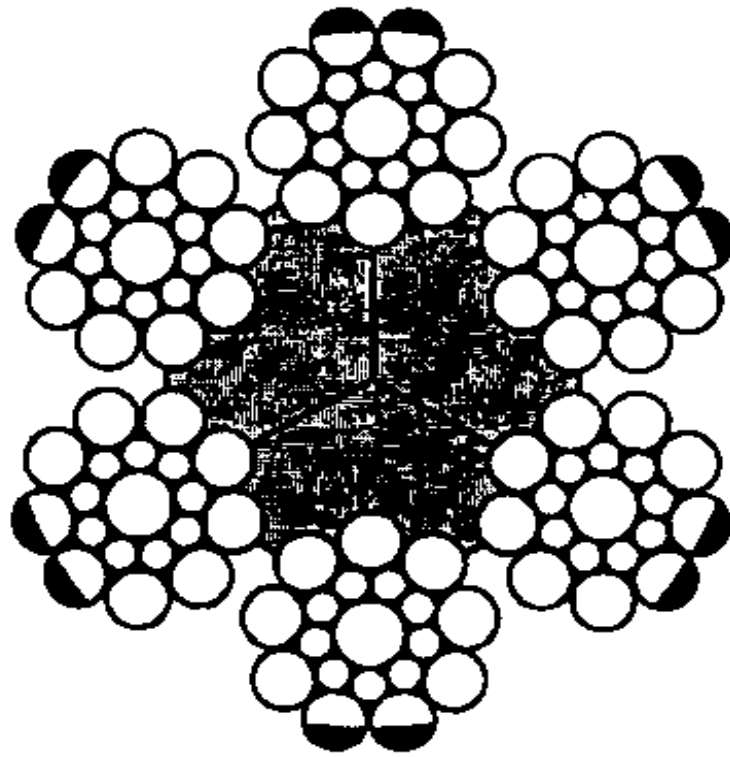

$$6 \times 2 \times 1/2 = 6$$

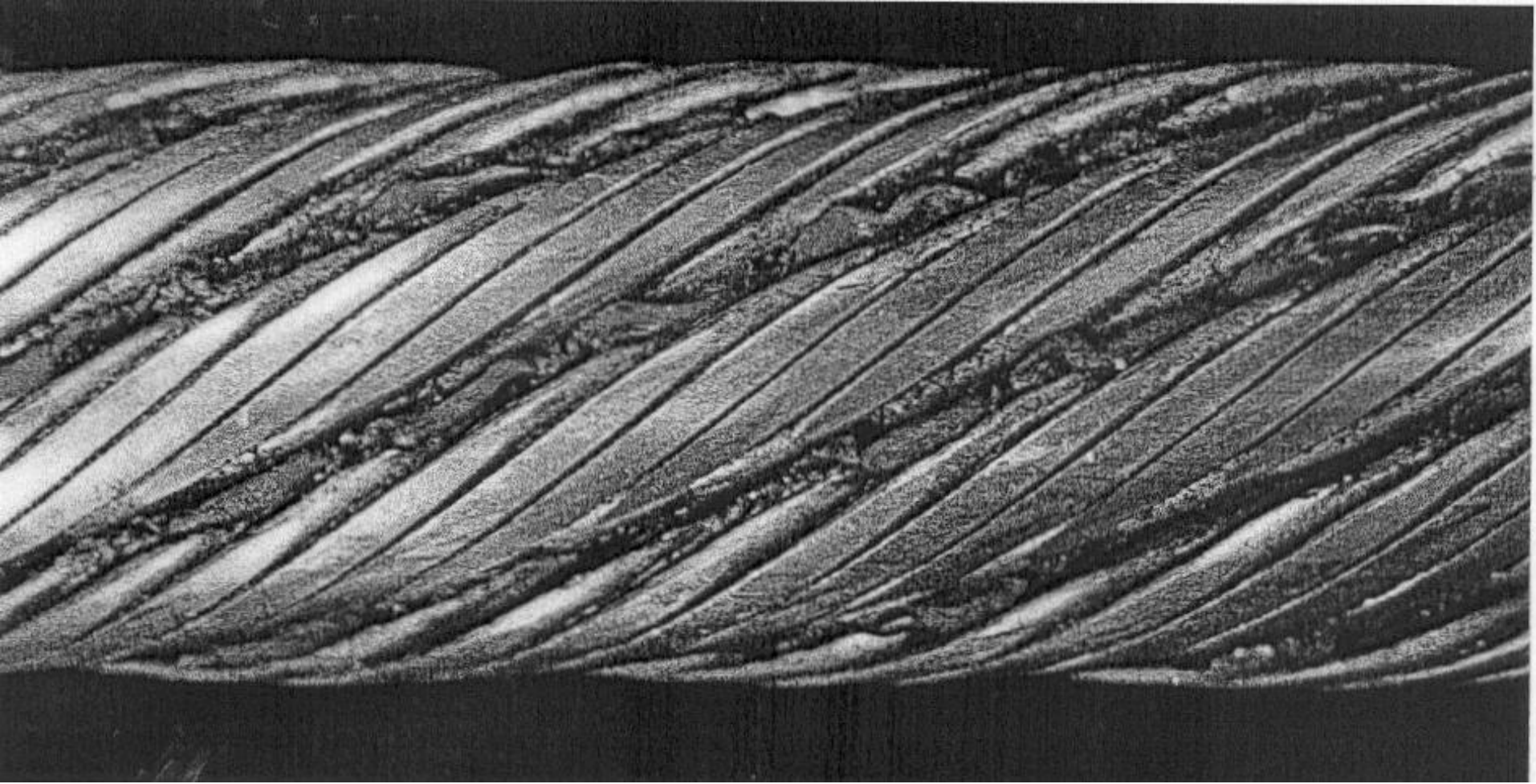

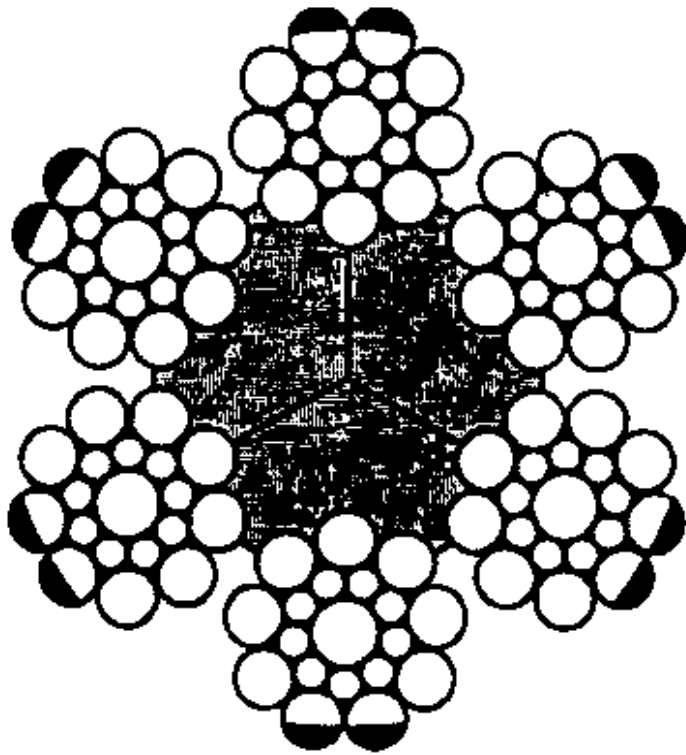

$$6 \times 2 \times 1/2 = 6$$

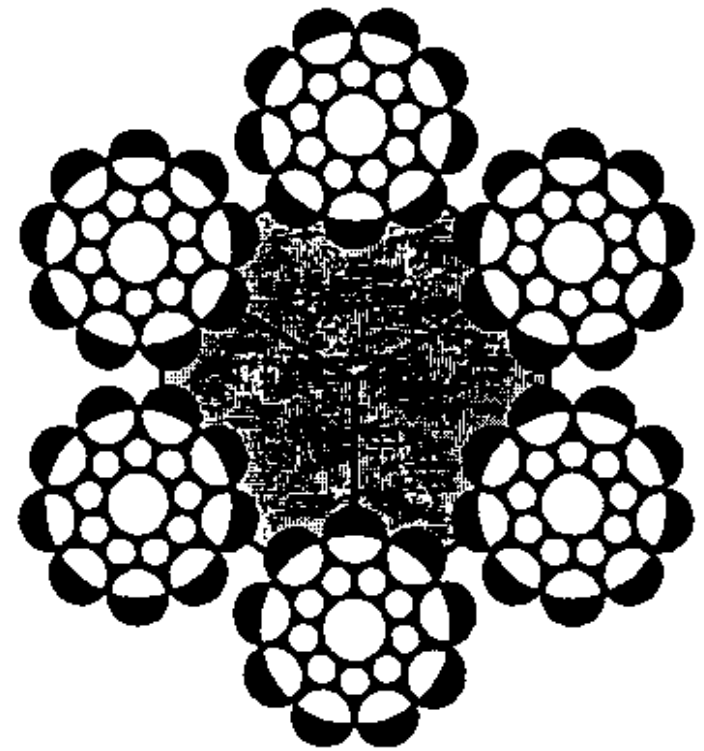

$$6 \times 9 \times 1/2 = 27$$

$$4.5 \times !!$$

HUMAN ERROR

CONSIDER

3-DIMENSIONAL PROBLEM

IN ONLY 2-DIMENSIONS

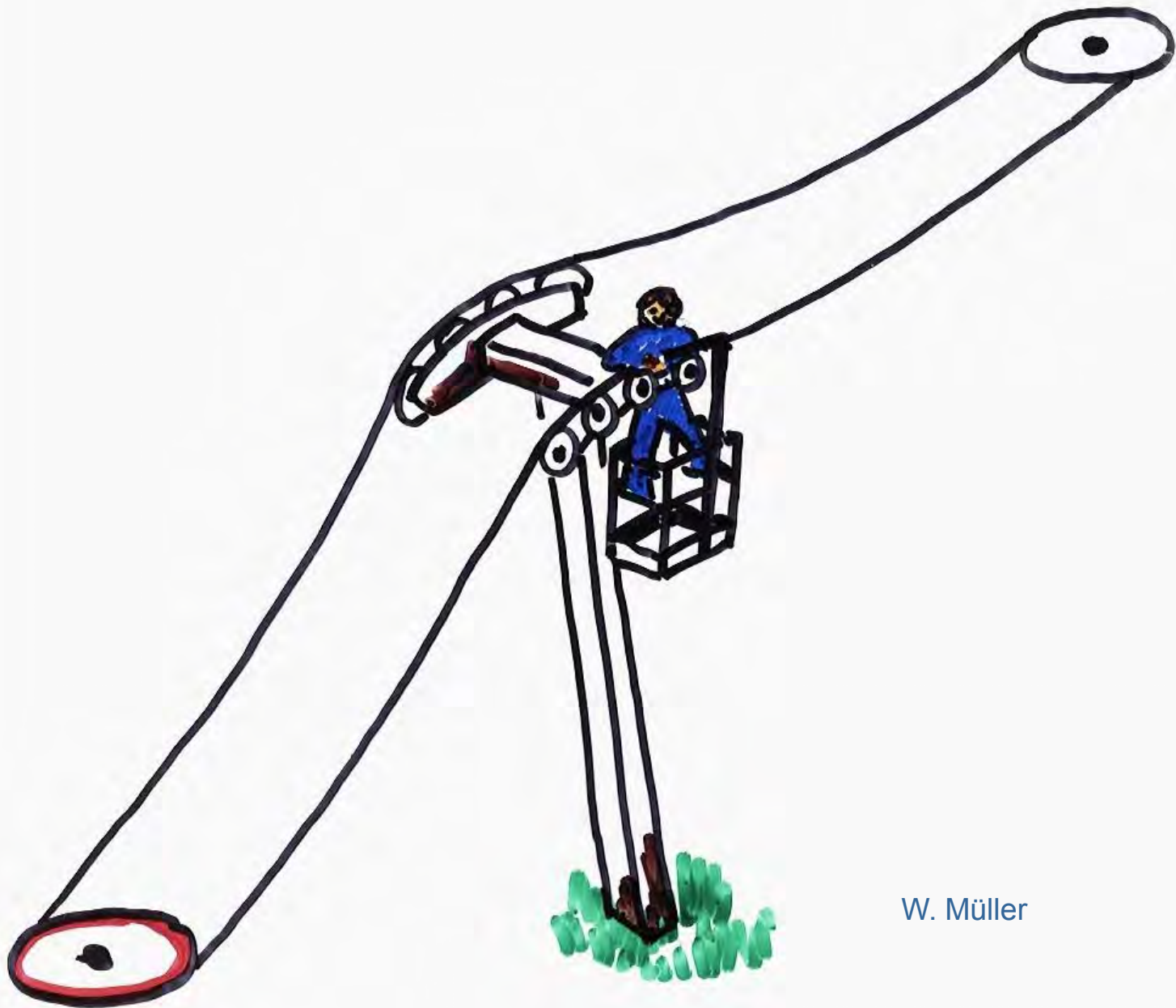

W. Müller

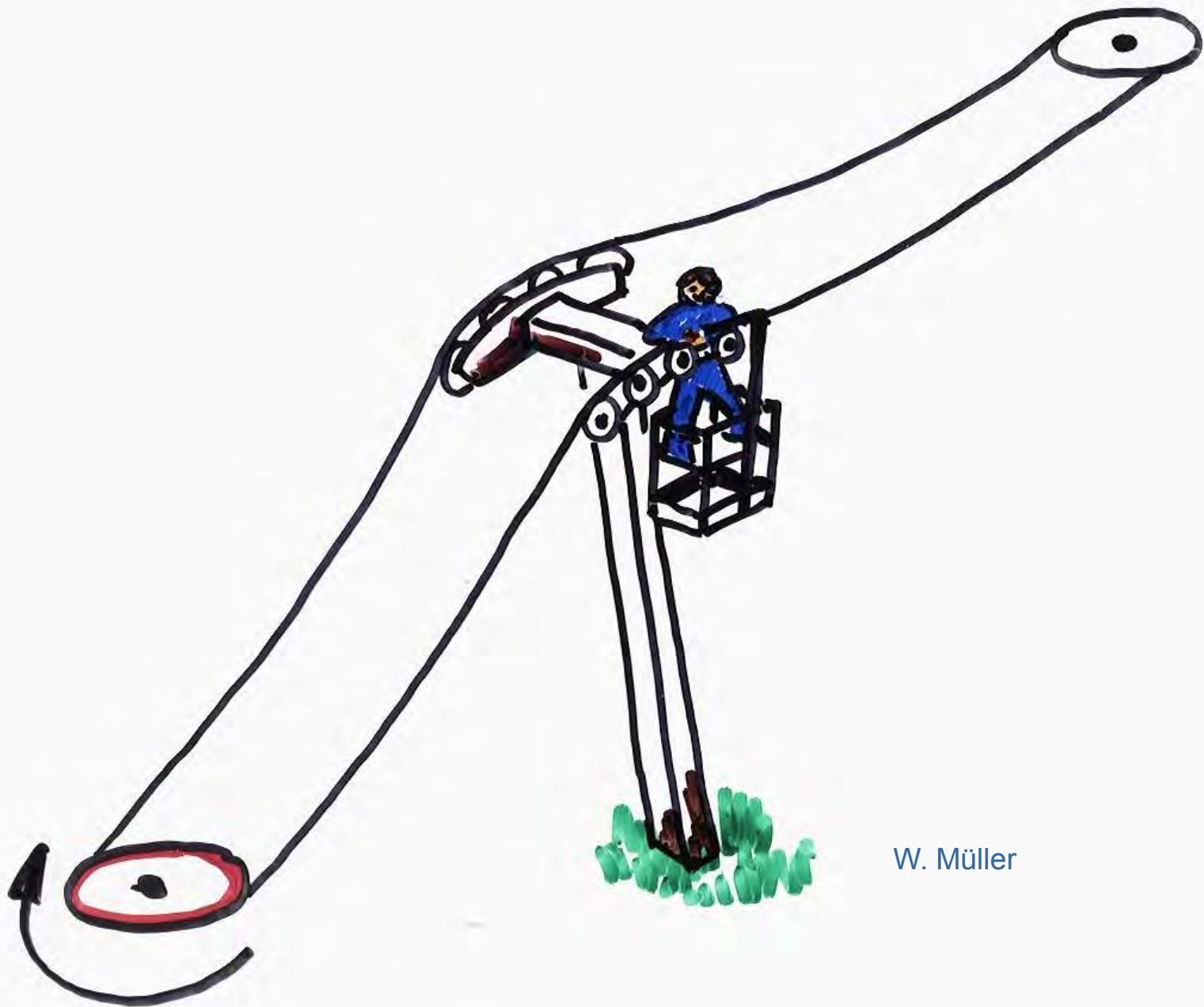

W. Müller

HUMAN ERROR

INSUFFICIENT
WRITTEN OR VERBAL
COMMUNICATION

On a drawing:

These holes must be drilled on
the first working day of the
week!

Original in German:

Zu bohren bei der Montage!

That means:

To be drilled during assembly!

If you follow this instructions, your parts will wear out sufficiently fast.

Please contact our parts department for replacements.

HUMAN ERROR

WE DO NOT
PAY ATTENTION TO THE
PRELIMINARY SYMPTOMS

WE DO NOT REALIZE THE
MECHANISM OF CHANGE

PRELIMINARY SYMPTOMS

Sound level

Temperature

Performance

Power consumption

Wear

Oil Drops

Slackening

Vibration

and others.....

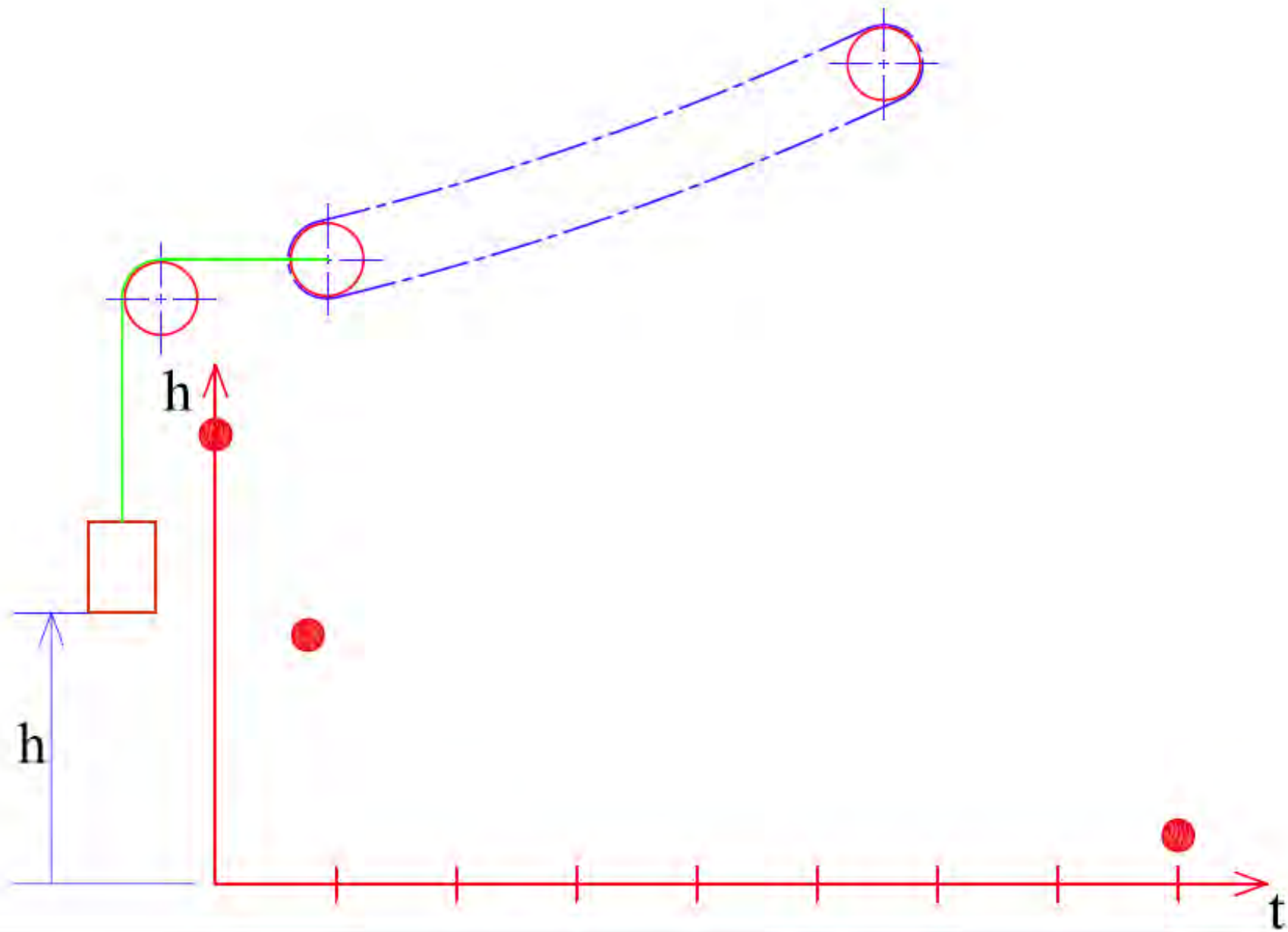

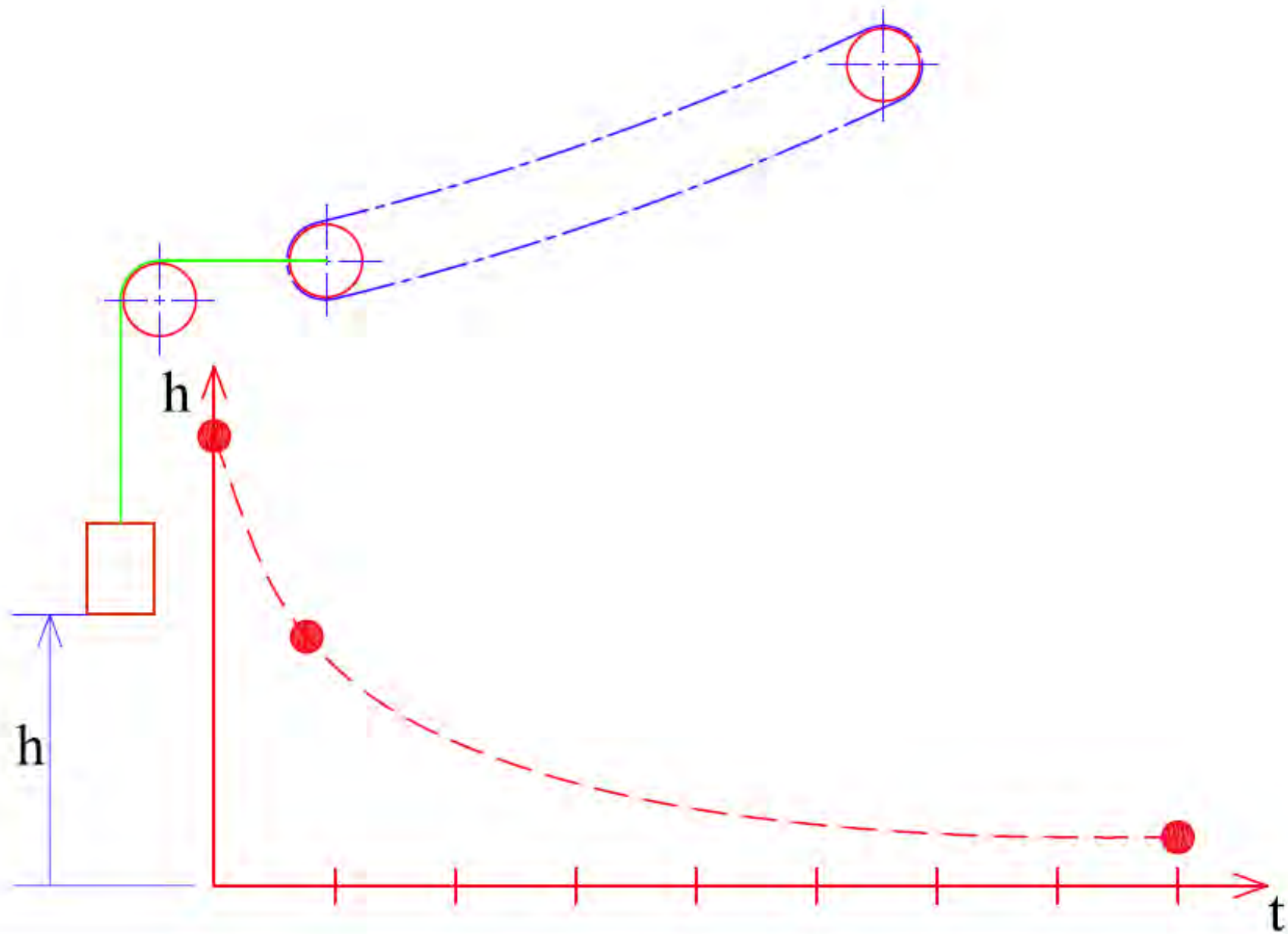

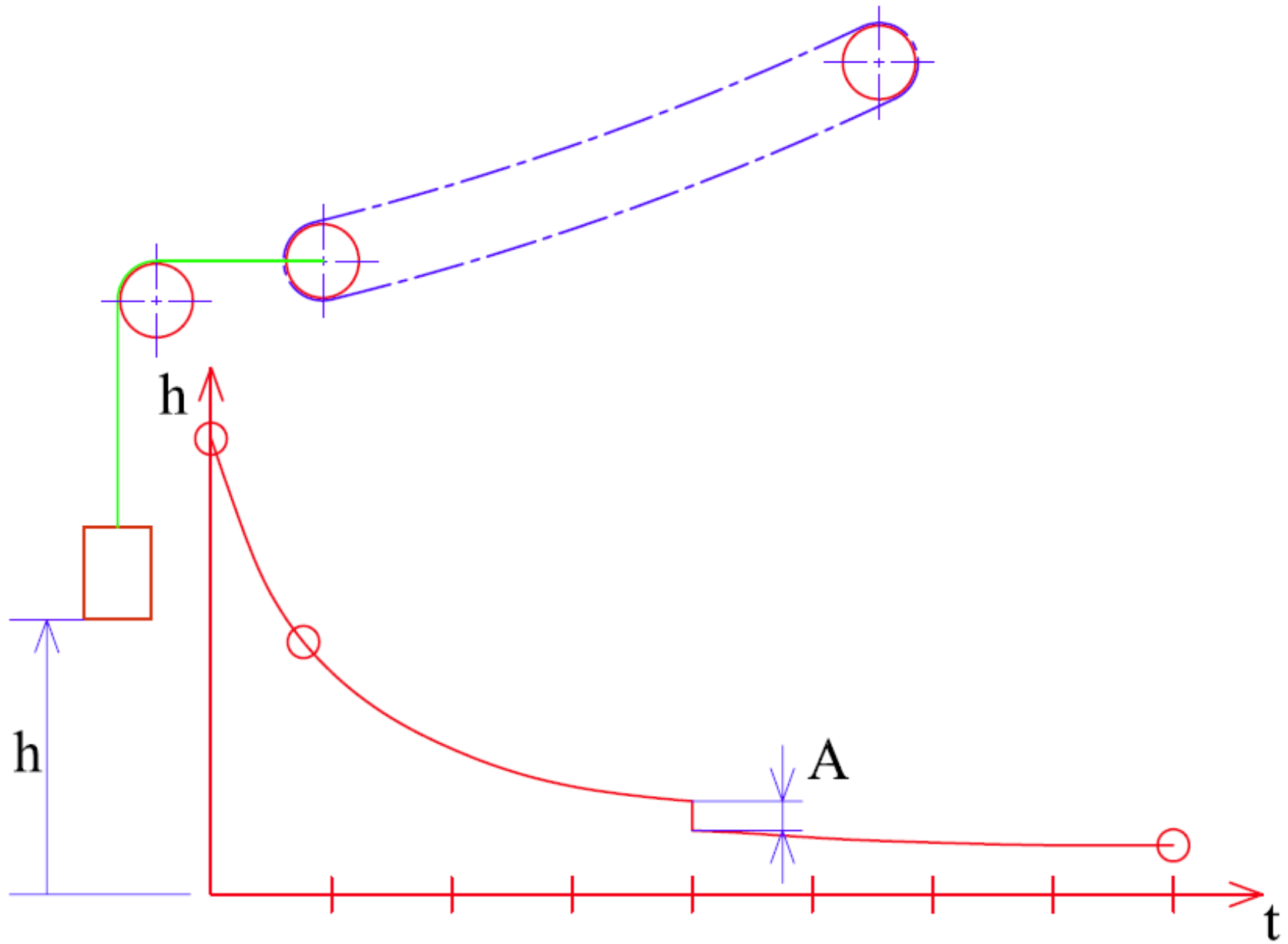

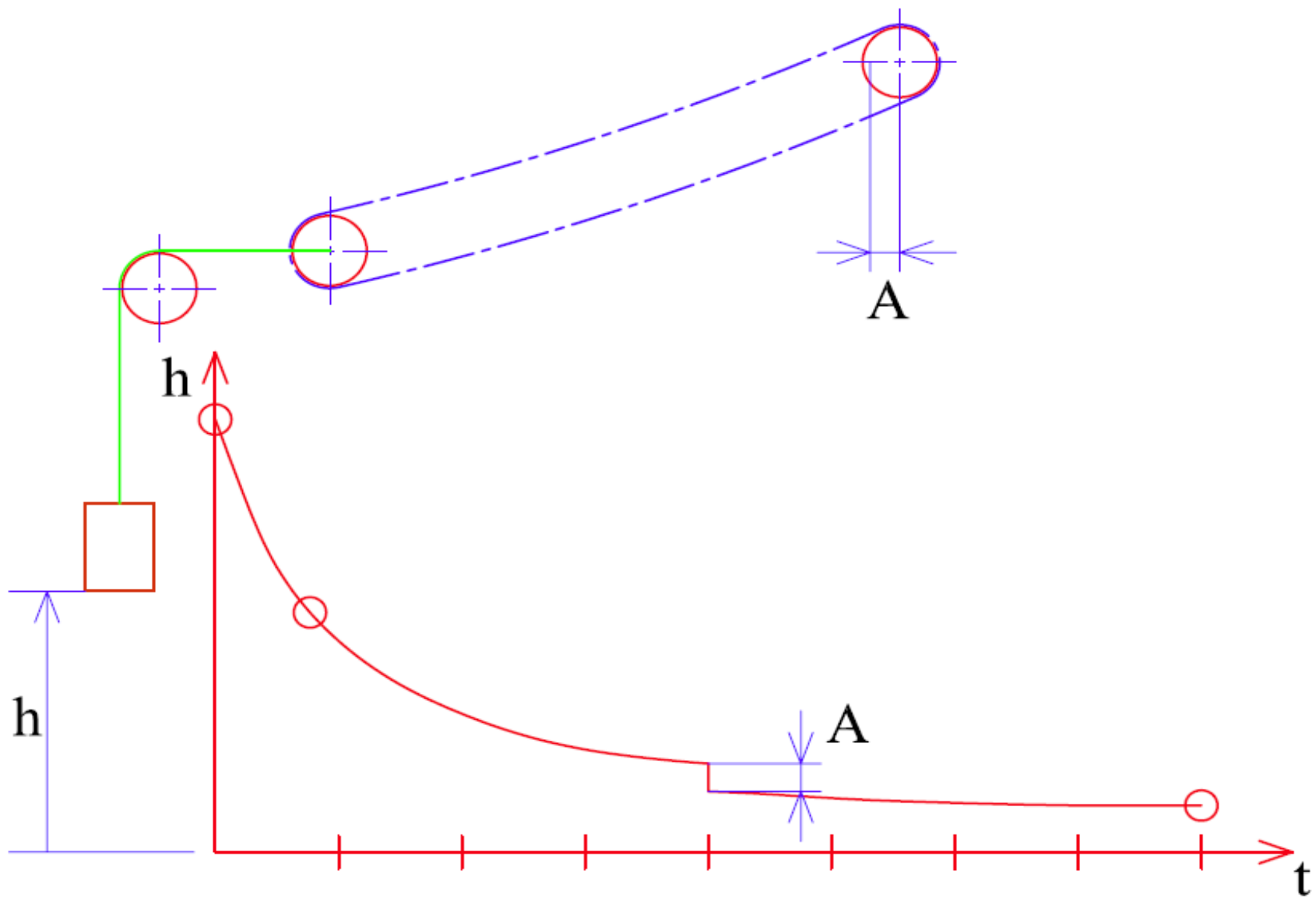



W. Müller

