



Reversible Ropeways at its limits

Bissig Iwan

Bozen/Bolzano 6 - 9 June 2017



Reversible Ropeways at its limits

Illustrated by examples of:

Monte Bianco

Halong Bay

Eibsee-Zugspitze

Ropeway Sántis

75- / 80-ATW Monte-Bianco, Italy



Technical Data ancient Tramway



	1	2	3
Inlined length	1809	2441	270
Difference in height	801	1148	131
System	31	23	8
Capacity	300	220	200

Lower Station Pontal d'Entrèves - 1.300 m



Intermediate Station Pavillon du Mont Fréty - 2.200 m



Upper Station Punta Helbronner - 3.500 m



Technical Data Skyway Monte Bianco

➤ System	80-ATW and 75-ATW
➤ New installation	2011 - 2015
➤ Inclined length	4300 m (~ 1700 m and ~ 2600 m)
➤ Diff. in elevation,	~ 2200 m (1300 m – 2200 m – 3500 m)
➤ Transport Capacity	800 pphd and 600 pphd
➤ Tower Height max.	110 m
➤ Track rope	70 mm
➤ Haul rope	42 / 32 mm
➤ Drive power	650 kW and 600 kW

Masterpiece of a Ropeway

- Elevation
- Permafrost soil and other geological adverse conditions
- Stations: mainly made of Steel and Glas
 - Self-sustaining (energy)
 - photovoltaic- and heat pump heating system
- Regenerative Brake Energy recovery for main power grid
- Panorama-Cabin 360°
 - Rotating cabin
 - Floor- and wall heating
 - Sound system and Screens (Livecam at cabin)
 - Water transport: 3000 Liter for Upper Station

Special Features at Stations



Special Features - Cabin



230-ATW Ha Long Bay, Vietnam



Main Technical data

➤ System	230-ATW
➤ Installation in	2015/2016
➤ Inclined Length	2165 m
➤ Vertical drop	88.5 m
➤ Travel speed	7 / 10 m/s
➤ Track Ropes	78 mm
➤ Haul Rope	57 mm
➤ Power	Nom.: 815 kW / Peak: 1900 kW

Longitudinal Profile

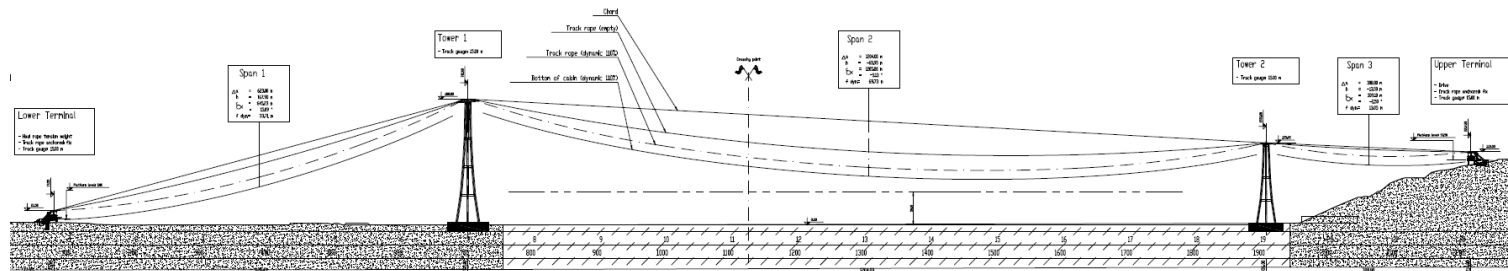

Project Schedule

- | | |
|---|------------|
| ➤ First inquiry | 11.08.2014 |
| ➤ Contract signed | 13.09.2014 |
| ➤ Start Construction of Stations | Dec. 2014 |
| ➤ Start Construction Towers | Jan. 2015 |
| ➤ Start Rope Pulling | Feb 2016 |
| ➤ Commissioning / Load Tests | May 2016 |
| ➤ Acceptance Certificate | 19.05.2016 |
| ➤ First Run 230 Passangers World Record | 31.05.2016 |
| ➤ Public Opening | 25.06.2016 |

Performances

- Engineering: ca. 11'000 h (internal Ressources)
- Installation: ca. 15'000 h (Supervision and Rope Pulling)
- Material: ca. 1'000'000 kg (1000 to)

Special Features - Cabin

- Cabin: Double-decker for 230 people
- L x W Length 11 m; Width 3.4 m
- Carriage 32-Rollers / $\varnothing 375\text{mm}$, no Track Rope Brakes



Special Features - Carrier



➤ 230-ATW Ha Long Bay

40 to corresponds with
500 Passengers

➤ 40to-ATW-MP Linth-Limmern

Special Features - Track

- World's Tallest Ropeway Tower (188.888 m)
- Tower is mainly made of concrete, only Tower Head is made of steel
- Concrete Construction: Special sliding formwork (Executing Firm: Gleitbau, Salzburg-Austria)

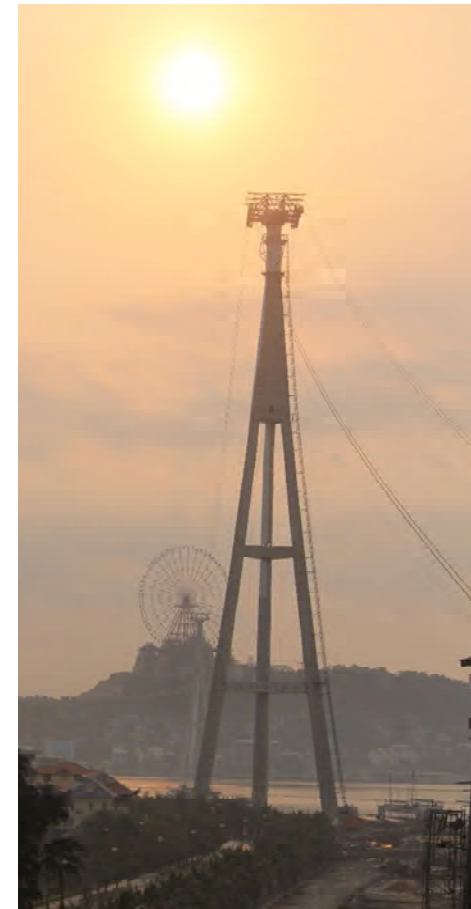

➤ 230-ATW Ha Long Bay

Tower 2: 123.45 m
3 Concrete Tubes,
each with \varnothing 5m



Tower 1: 188.88 m !



Special Features - Installation

- Rope Pulling: Continuous Shipping underneath Ropes required 60 to Holding Back / 65 to Pulling
- Linear Rope pulling Unit «up in the air» (Lack of space)
- Approx. 300 to Installation equipment
- Installation: no Helicopters were available

120-ATW Eibsee – Zugspitze, Germany



Technical Data

- System 120-ATW
- Difference in elevation **1945 m**
- Inclined length 4460 m
- Longest span **3213 m**
- Inclination max. 106.1 %
- Steel tower **127 m**

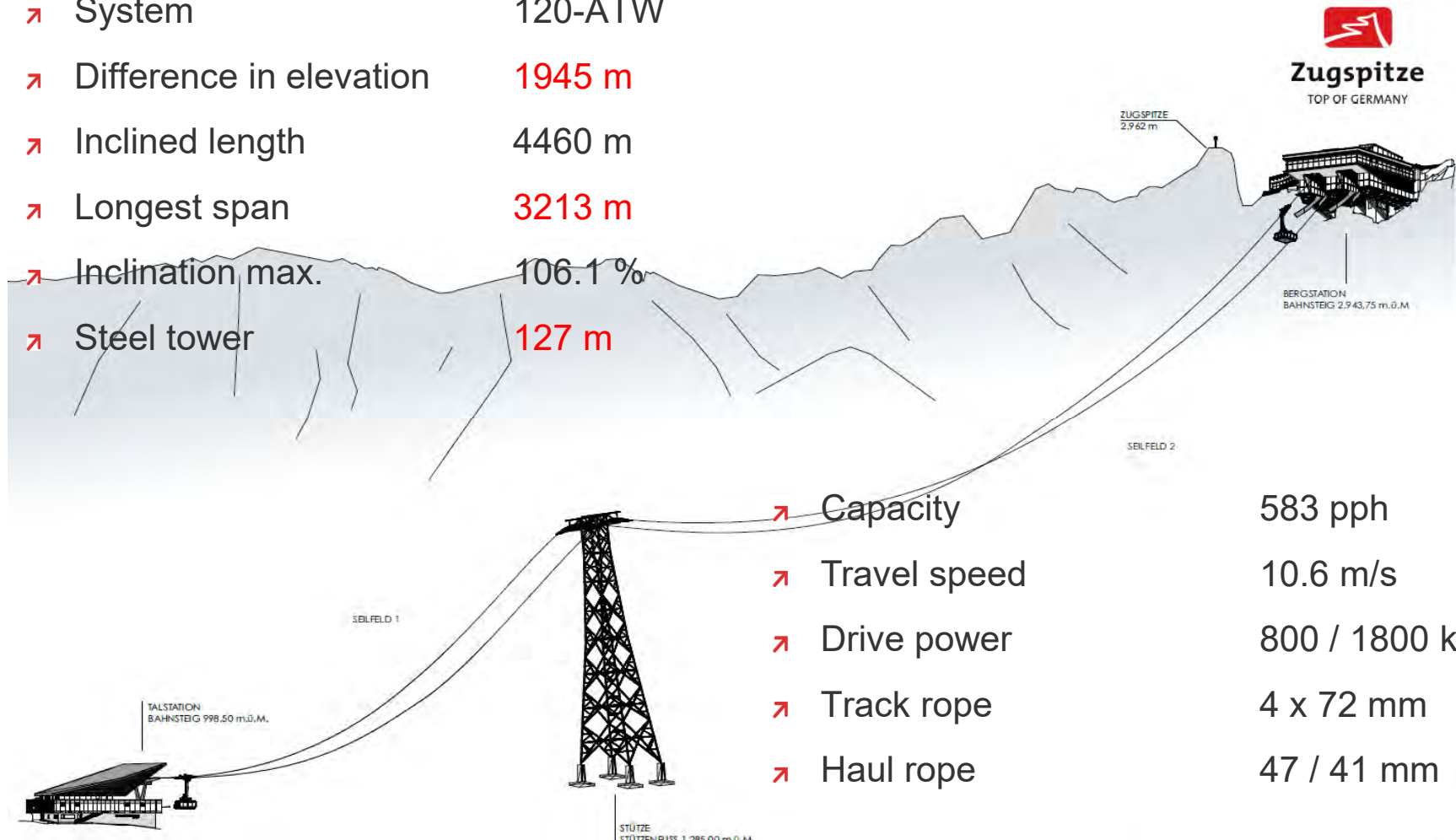

- Capacity 583 pph
- Travel speed 10.6 m/s
- Drive power 800 / 1800 kW
- Track rope 4 x 72 mm
- Haul rope 47 / 41 mm

Difference in Elevation: 13 m bis 1945 m

↗ 120-ATW Eibsee – Zugspitze

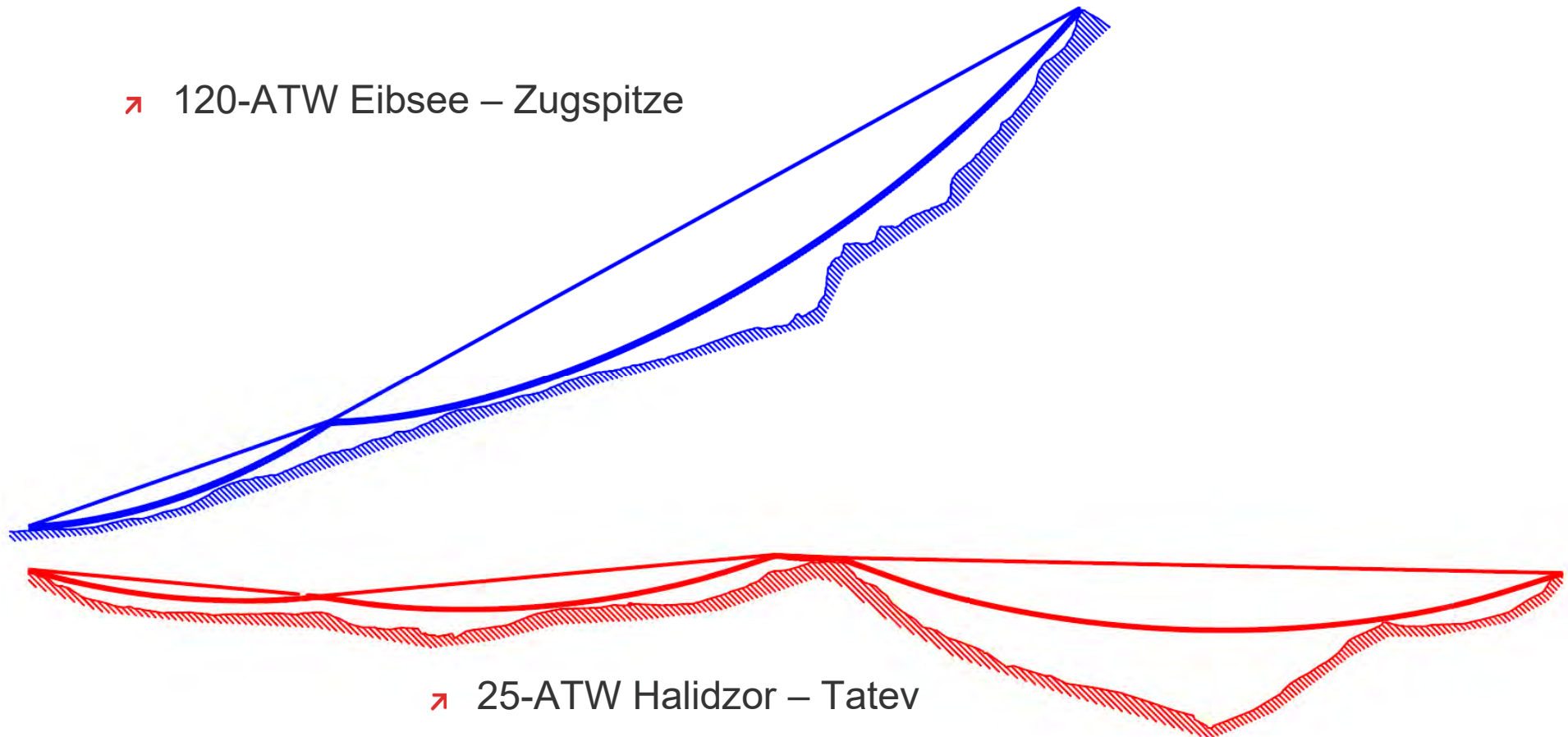

↗ 25-ATW Halidzor – Tatev

Longest rope span: 390 m bis 3213 m

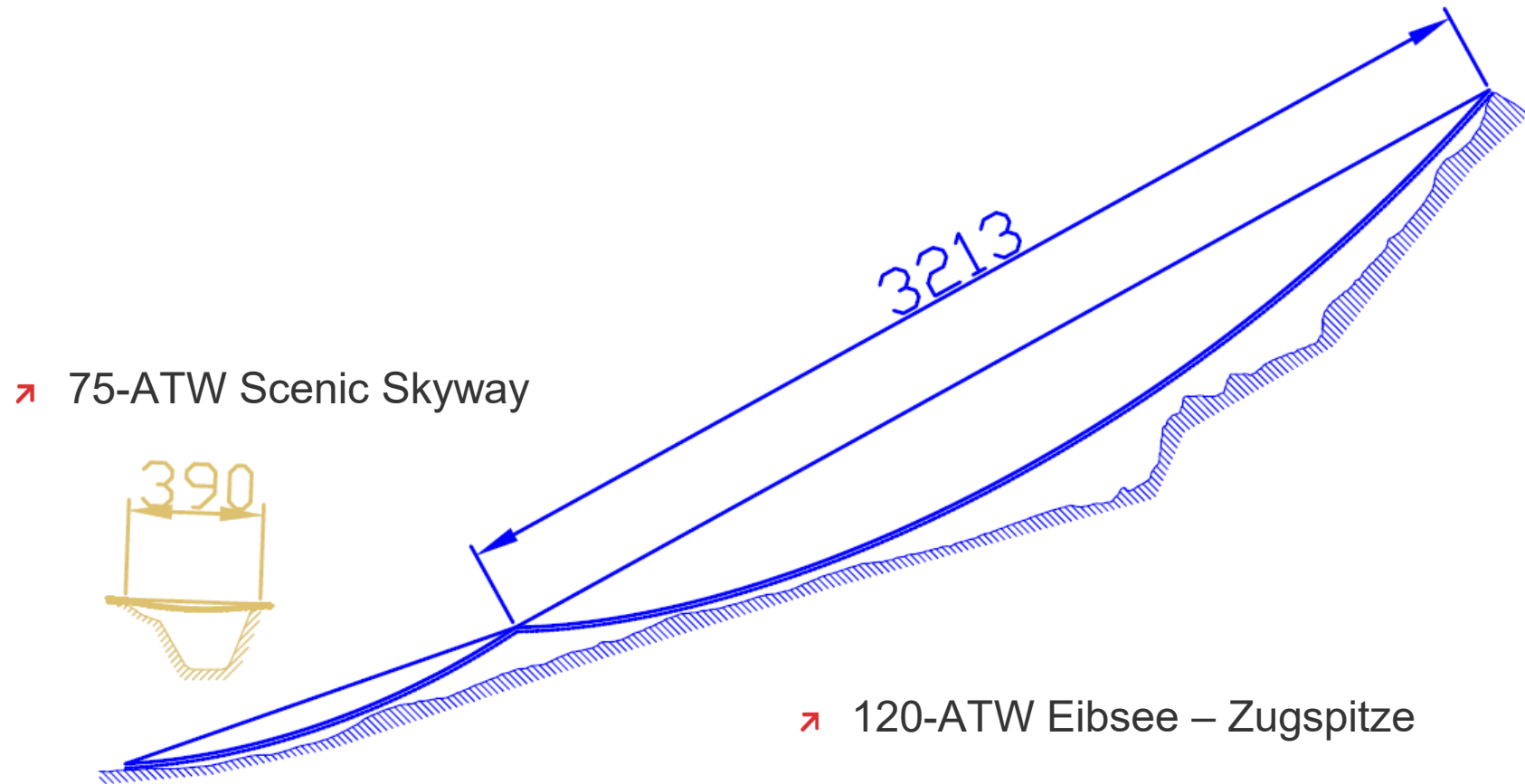

Project Schedule

➤ Phase 1 – 2016

- Bottom station
 - Civil work complet
 - Mechanical equipment
 - Drive
- Top station
 - Civil work for station-towers
 - Retraction structure
 - Mechanical equipment
- Line
 - Civil work for towers

➤ Phase 2 – 2017

- Bottom station
 - Interior finish station
 - Electrical equipment
- Top station
 - Civil work for platforms
 - Steel structure & facades
 - Interior finish
 - Mechanical equipment
- Line
 - Steel structure tower
 - Rope pulling

➤ **Opening**

20.12.2017

Bottom Station «Eibsee» / Final design



Bottom Station «Eibsee» / Station concept

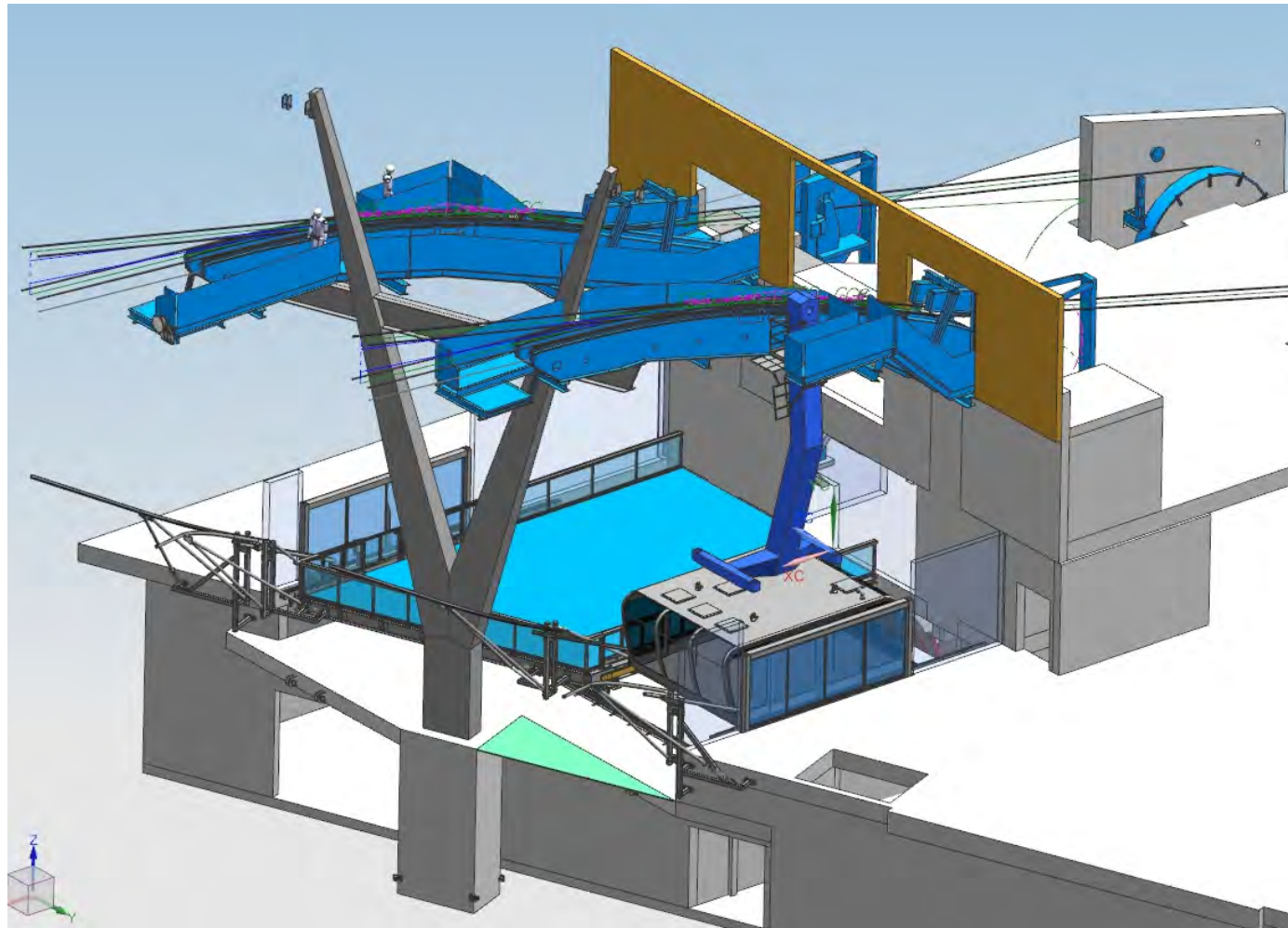

Bottom station «Eibsee» / Drive

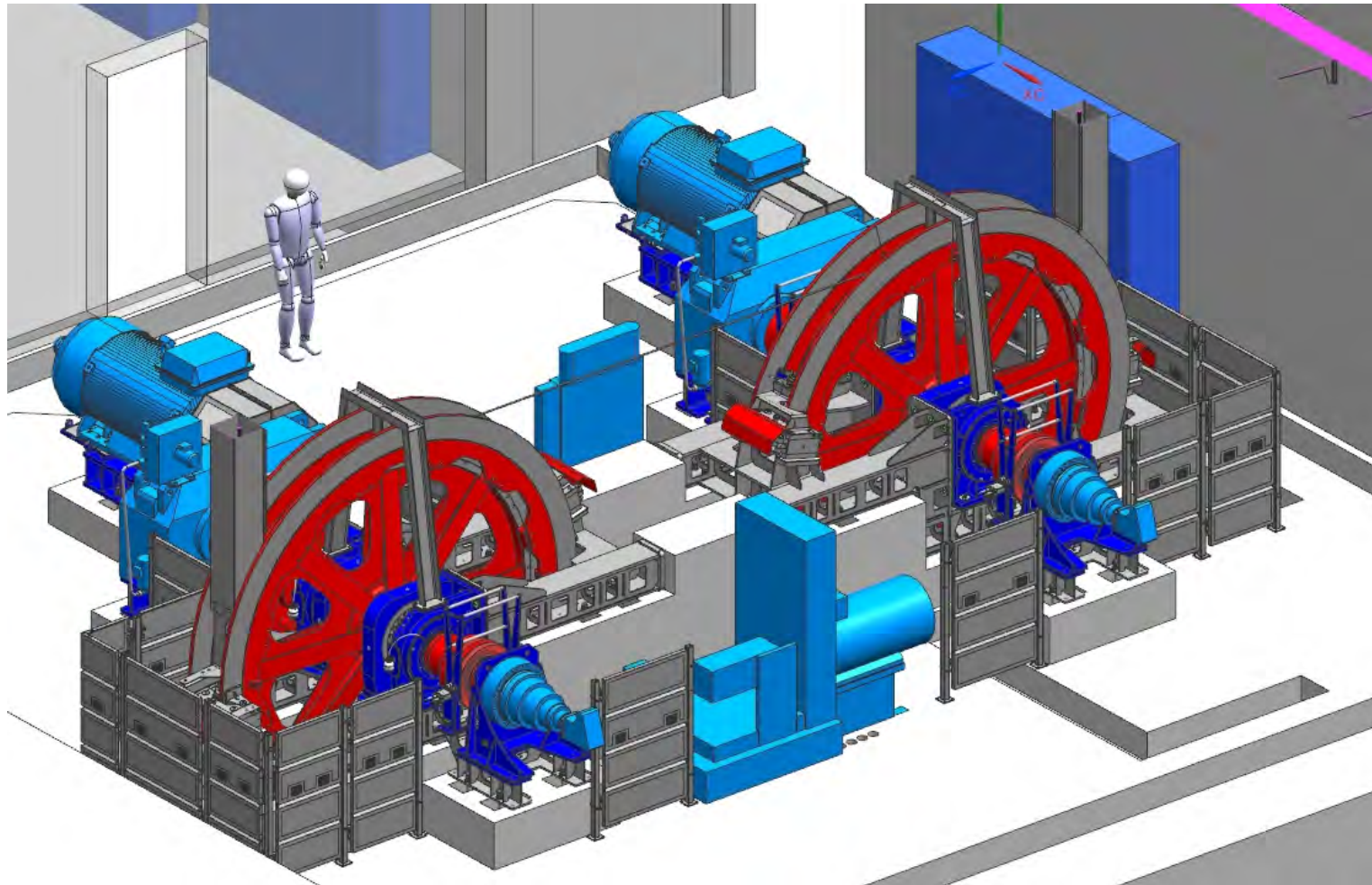

Top Station «Zugspitze» / Static concept

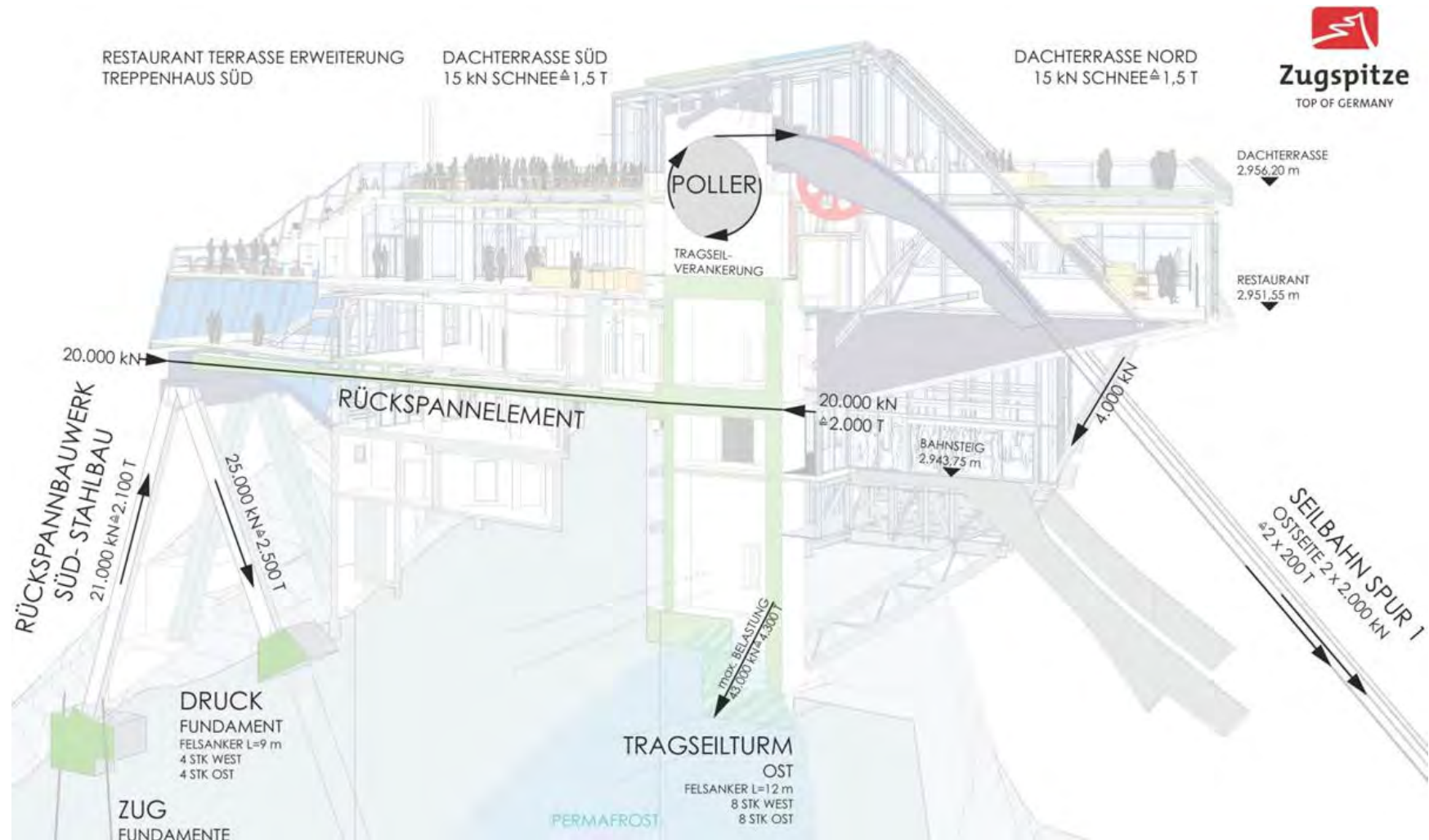

Top Station «Zugspitze» / Old installation still operating

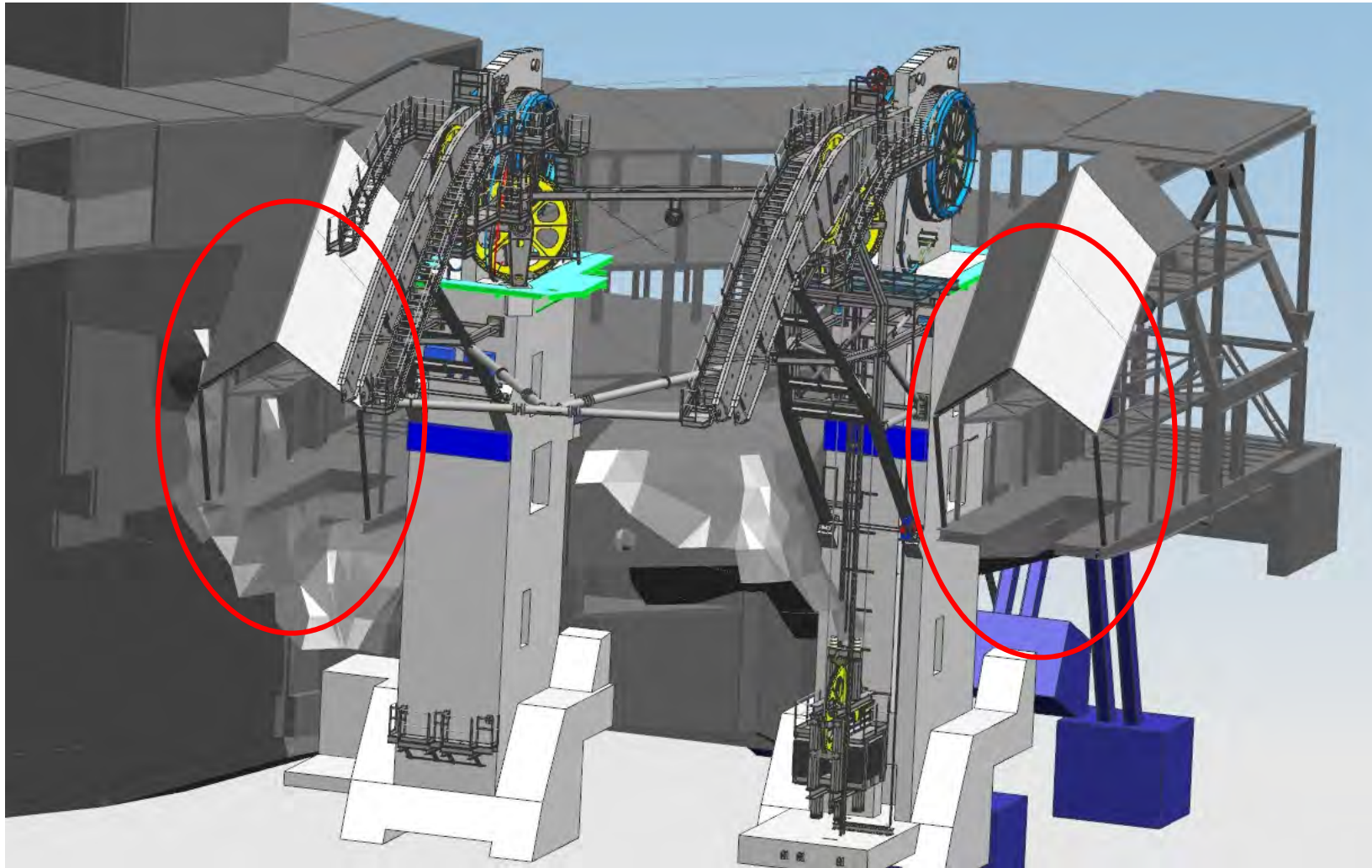

Top Station «Zugspitze» / Mechanical equipmement

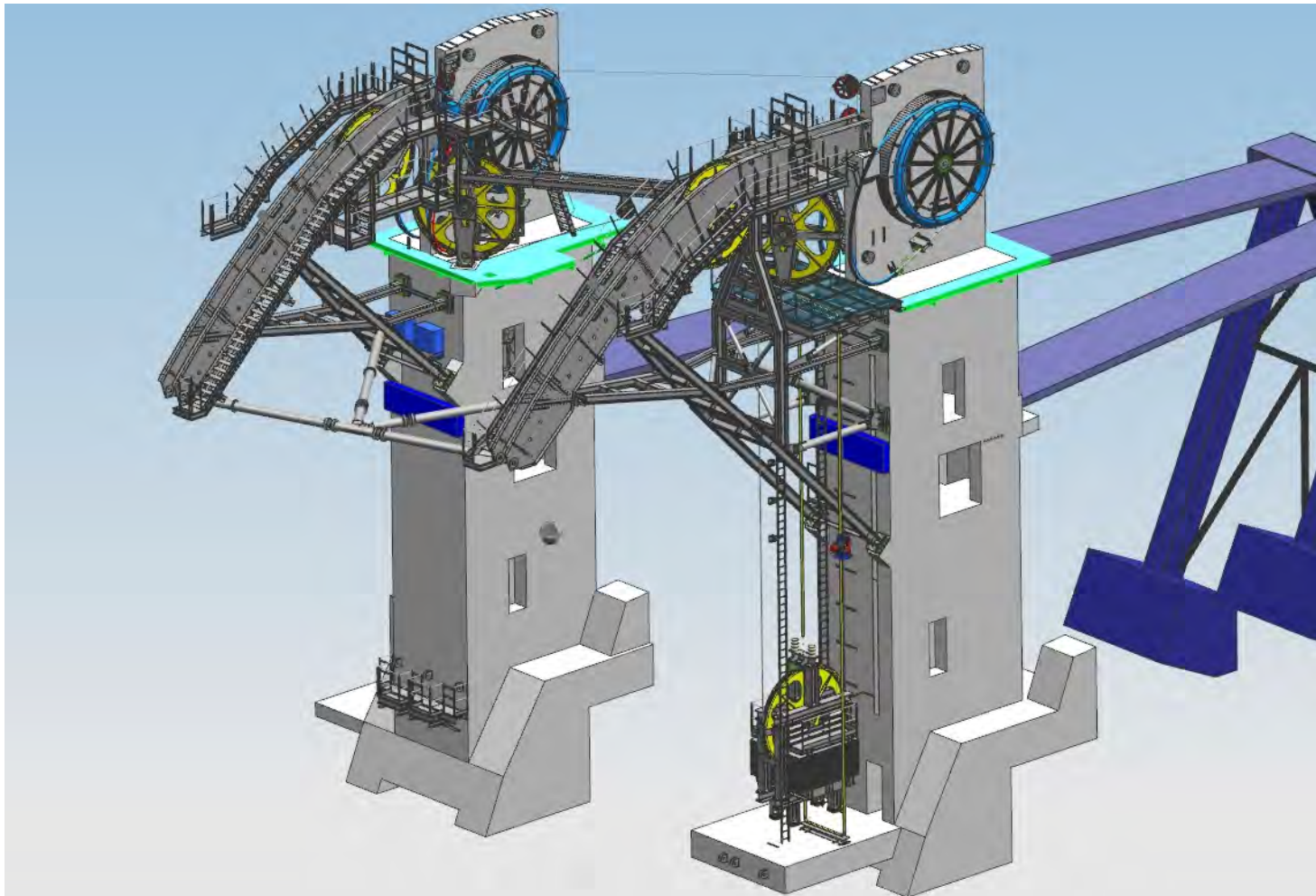

Top Station «Zugspitze» / Steel structure

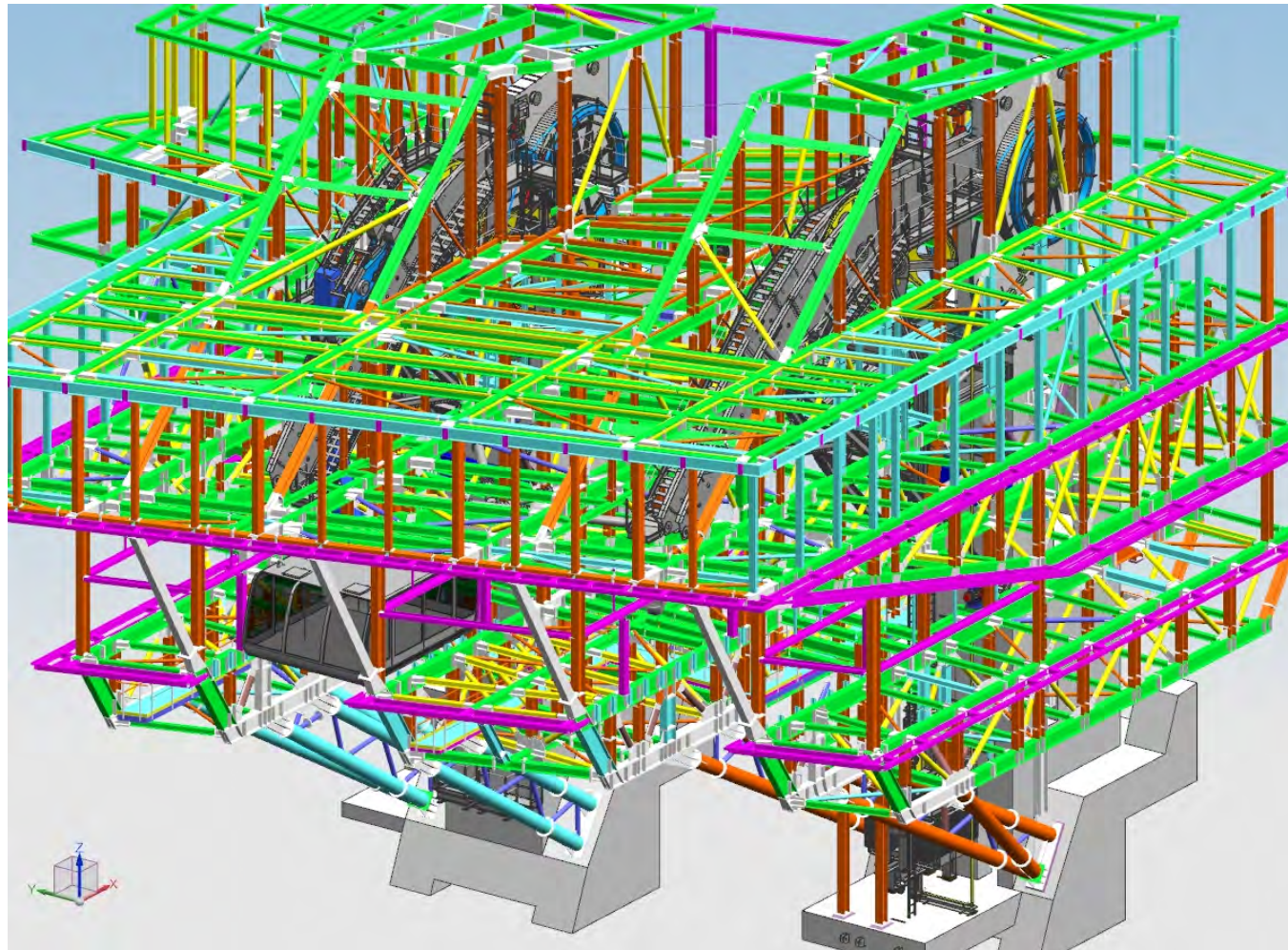

Top Station «Zugspitze» / Final design



Top Station «Zugspitze» / Impressions



Vehicle 120-ATW

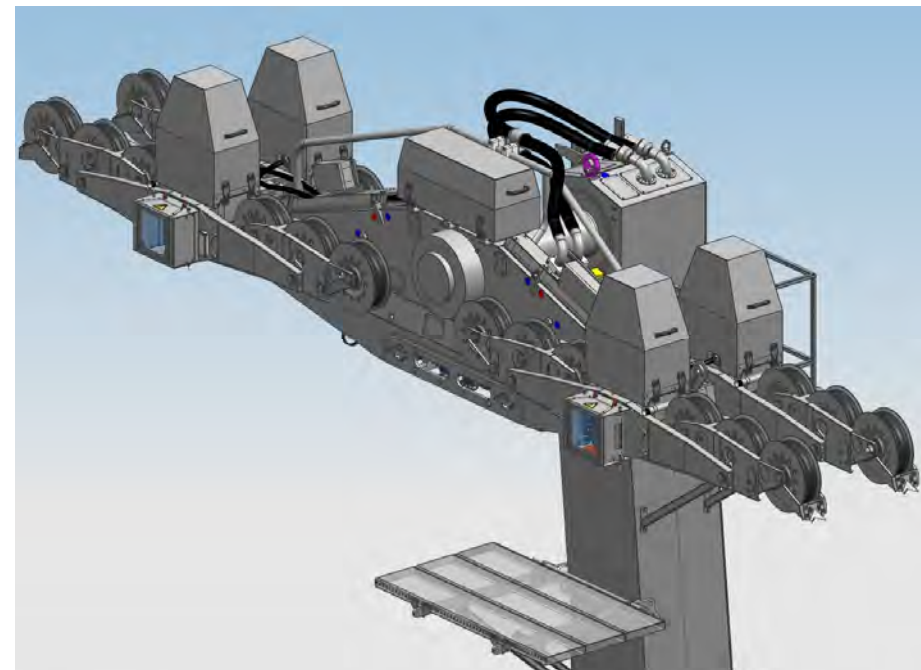

Building the Top Station....

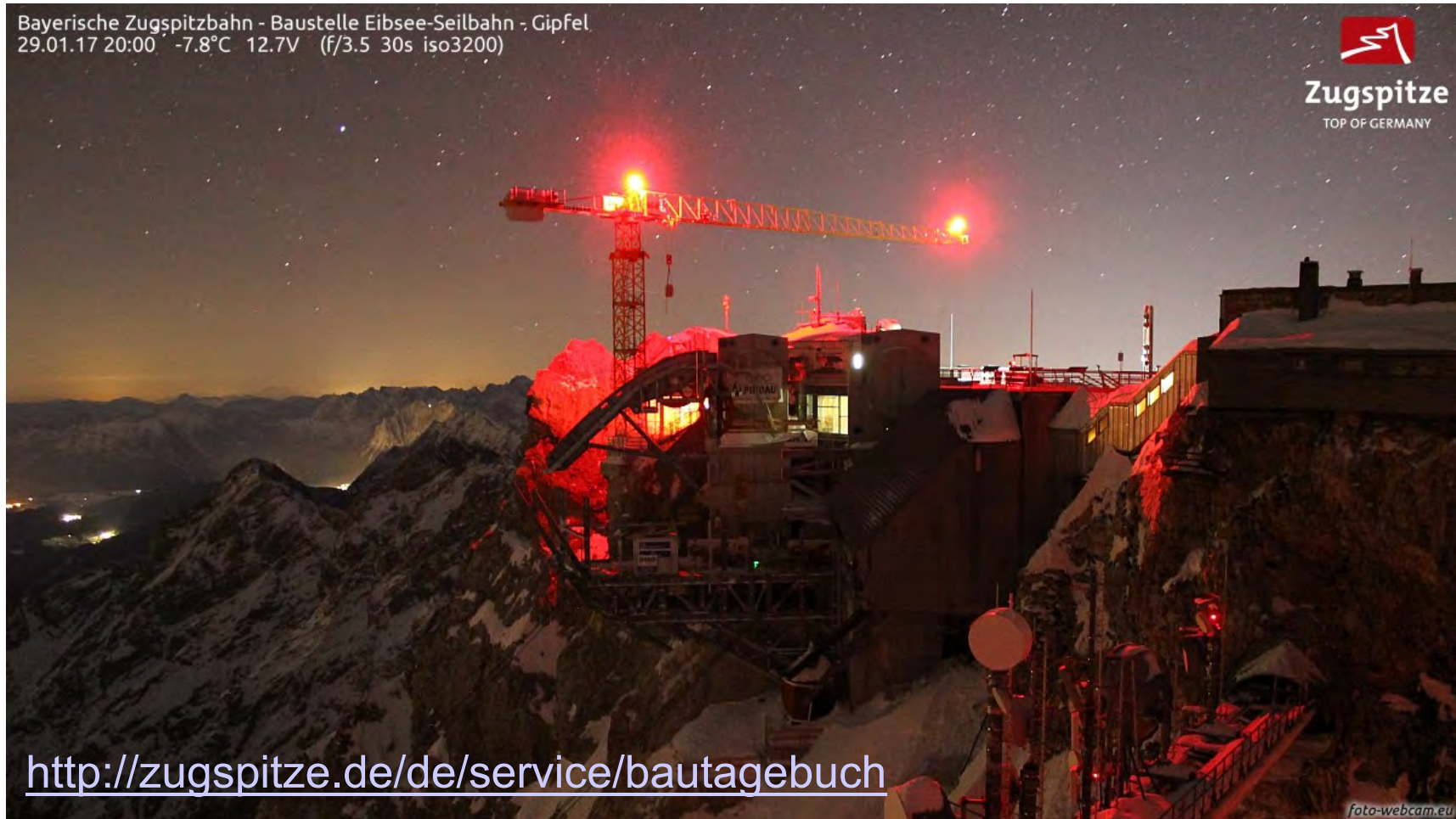

How about the future with Reversible Ropeways?

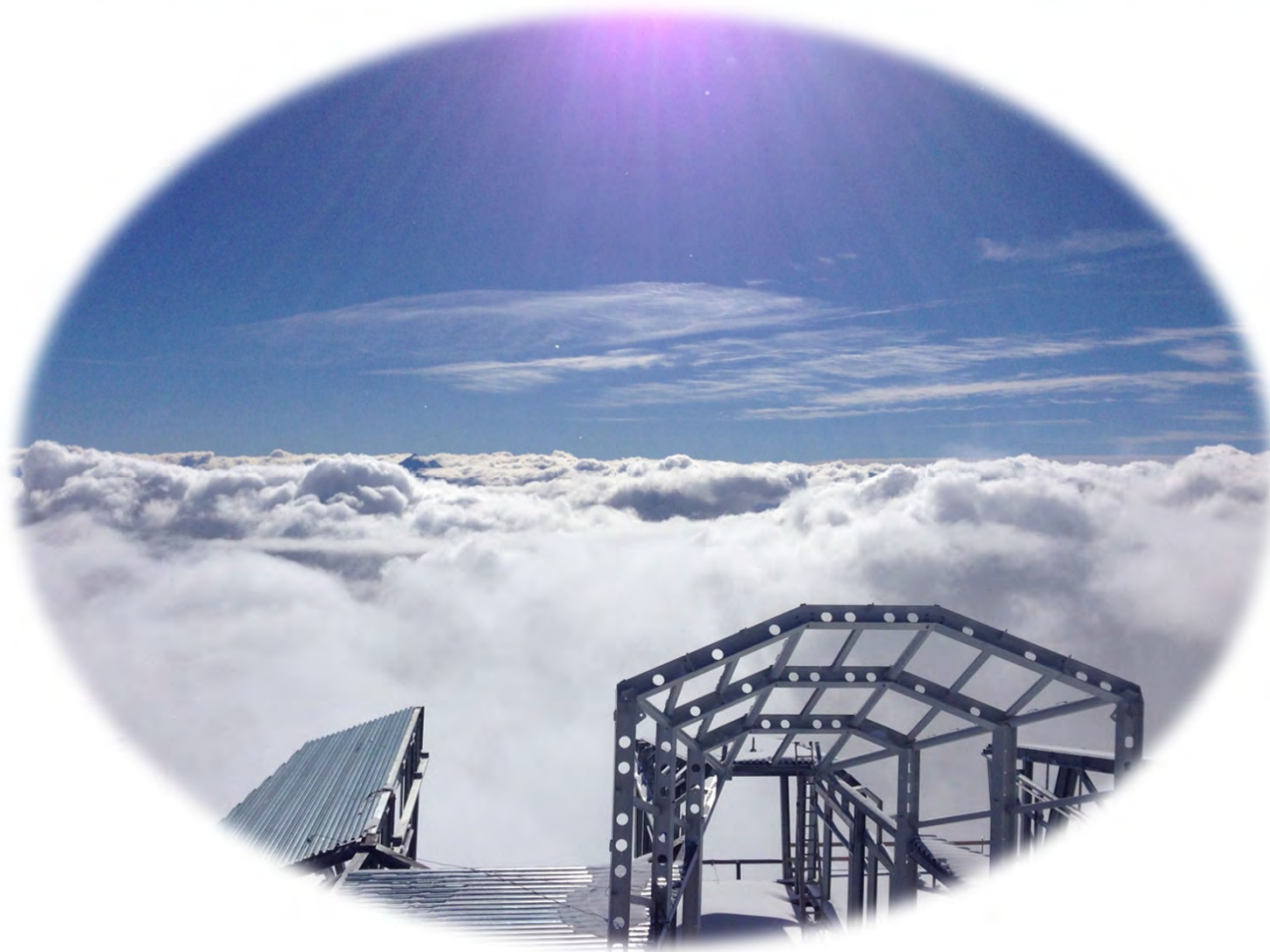

How about the future with Reversible Ropeways?

By the way: Wetterhornaufzug,
Grindelwald!

- Erected in 1908
- Manufacturer: Von Roll
- Maximum Slope approx. 60°
- Cabin with Top Deck

