



ORGANIZZAZIONE INTERNAZIONALE TRASPORTI A FUNE
INTERNATIONALE ORGANISATION FÜR DAS SEILBAHNWESEN
ORGANISATION INTERNATIONALE DES TRANSPORTS À CÂBLES
INTERNATIONAL ORGANIZATION FOR TRANSPORTATION BY ROPE
ORGANIZACIÓN INTERNACIONAL DE TRANSPORTES POR CABLE

O.I.T.A.F. Seminar Work Committee No. II

**Get the best out of your ropes!
Holen Sie das Beste aus Ihren Seilen!
Utilisez au mieux Vos câbles!
Ottenga il meglio dalle Sue funi!**

Mag. Jörg Schröttner
joerg.schroettner@bmk.gv.at

20.04.2023



ORGANIZZAZIONE INTERNAZIONALE TRASPORTI A FUNE
INTERNATIONALE ORGANISATION FÜR DAS SEILBAHNWESEN
ORGANISATION INTERNATIONALE DES TRANSPORTS À CÂBLES
INTERNATIONAL ORGANIZATION FOR TRANSPORTATION BY ROPE
ORGANIZACIÓN INTERNACIONAL DE TRANSPORTES POR CABLE

OITAF international congress in Vancouver/Kananda

Save the date: 17th -21st June 2024

ROPEWAYS – SMART TRANSPORT SOLUTIONS

**Development of ropeways in urban and tourist areas
Operation of ropeways
Ropeway technology
Dimensions of sustainability**

20.04.2023



ORGANIZZAZIONE INTERNAZIONALE TRASPORTI A FUNE
INTERNATIONALE ORGANISATION FÜR DAS SEILBAHNWESEN
ORGANISATION INTERNATIONALE DES TRANSPORTS À CÂBLES
INTERNATIONAL ORGANIZATION FOR TRANSPORTATION BY ROPE
ORGANIZACIÓN INTERNACIONAL DE TRANSPORTES POR CABLE

O.I.T.A.F. Seminar Work Committee No. II

Introduction of the «Ropes» Group OITAF-Recommendation „Rope Lifetime“ Historical Introduction

Dr.-Ing. Konstantin Kuehner
konstantin.kuehner@jakob.eu

20.04.2023

Introduction of Work Committee (WC) II «Ropes»



Chairman: Sven Winter
Vice Chair / Protocol: Stéphane Pernot

#Manufacturers: Doppelmayr, Leitner Ropeways,
Fatzer, Jakob Rope Systems, Teufelberger-Redaelli,
Usha Martin

#Testing Bodies: IFT University of Stuttgart, IWM,
Letscan, ROTEC, TÜV SÜD, TVFA

#Authorities: BAV, BMVIT, IKSS, INTI, STRMTG

#Operators: Bayerische Zugspitzbahn,
Sommerbergbahn Bad Wildbad, Sandia Peak
Tramway, Zermatt Bergbahnen

*Interested guests or new members with rope
experience are welcome!*



Introduction of Study Commission (SC) II «Ropes»



Meetings usually 2 times per year

2018

Argentina | Berlin

2019

Winterthur | Garmisch-Partenkirchen

2020/21

online

2022

online | Stuttgart

2023

Oberstdorf



Introduction of Working Group «Ropes»



Paper 28 / 2014

General recommendations for the **manufacturers lubrication and the re-lubrication** of steel wire ropes used in ropeway installations for Passengers

Paper 3-1 / 2015

Survey of **magnetic rope testing** of steel wire ropes

Paper 30 / 2019

Possibilities to improve **visual rope inspection (VI)**

Close to finishing and publishing: **Ropelifetime**

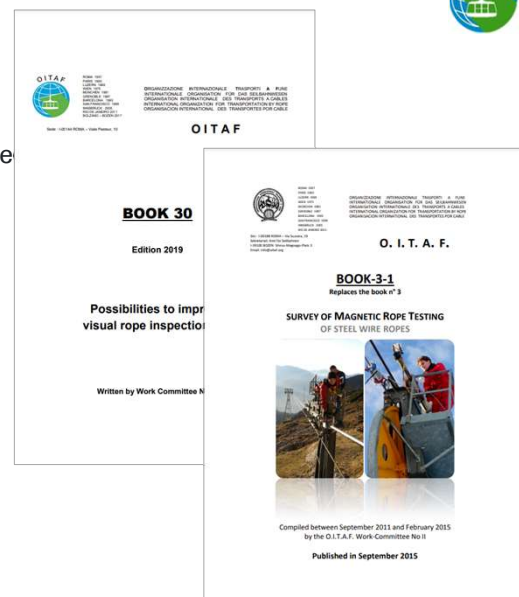

New Paper: Rope Lifetime

* Focus on Stranded Ropes *

Basics about wire ropes used in ropeways

- Wire manufacturing, strand and rope designs
- Transport & assembly
- Rope end connections

Operational influences, e.g.:

- Vehicle clamps
- Rollers, sheaves
- drive, speed

Unscheduled influences, e.g.:

- twist, damage events, environment, heat, ...
- Special incidents out of experience of the group members



New Paper: Rope Lifetime

Degradation mechanisms

Free rope length – fatigue, wear/abrasion, corrosion
Splice and end connections – wear/abrasion, twist

Theoretical lifetime estimation by calculation

Lifetime estimation by Feyrer / University of Stuttgart
Special Interest: lifetime estimation method of Leipzig

Example Calculations

Discussion of Results



IFT University of Stuttgart

Prof. Klaus Feyrer
1930-2020



Historical Introduction

- 1834 Invention of the wire rope
- 1890-1920 Material ropeways by Bleichert & Co.
- end 1920s First passenger ropeways
- since ~1927 Research / 1st bending-tests in Karlsruhe and Stuttgart
- 1936 Patent magneto-inductive rope testing

- 1980s First versions of Feyrer Formula
- 2000 + + Online monitoring, lifetime calculations
- 2005 European Standardization

- Future Inspection Intervals based on bending cycles

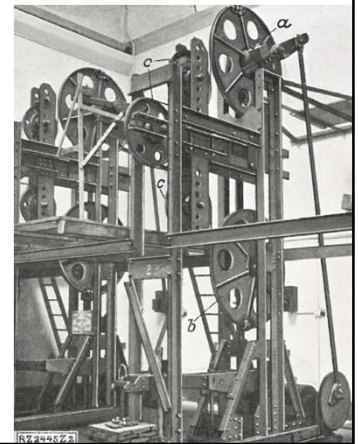
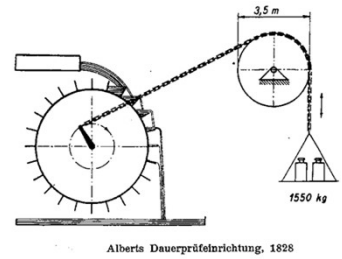

Brief History of Stranded Ropes

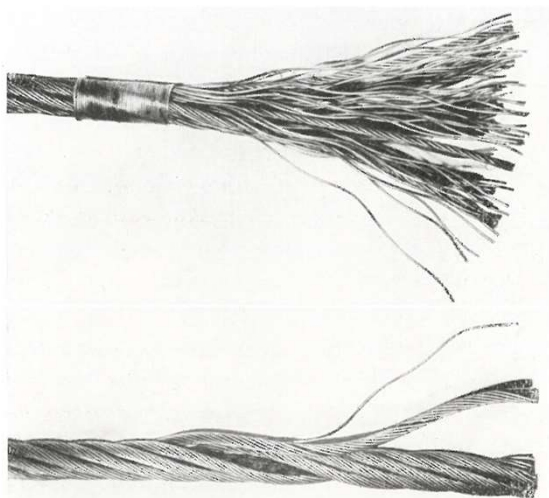

"Truelay" – relaxed pre-formed rope compound since the 1920s

~ 2000

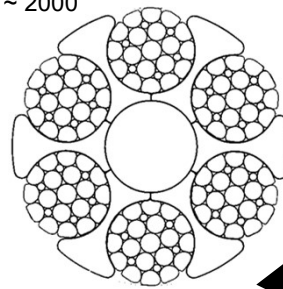

1834

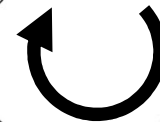

~ 1920

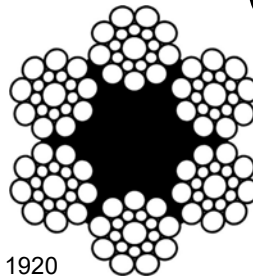

~ 1870

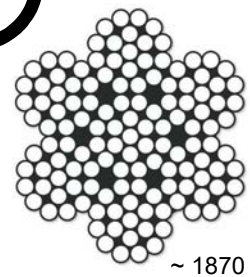

Brief History of Ropeways

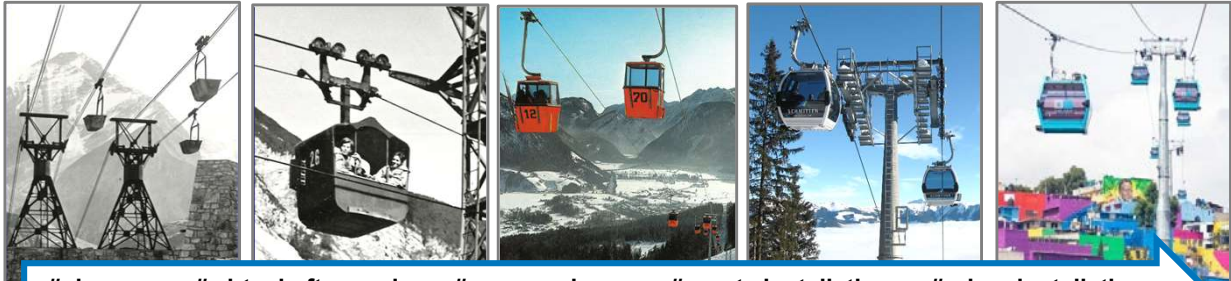

#pioneers #wirtschaftswunder #ropeway boom #sports installations #urban installations



Development of Installation Cycles



#pioneers #wirtschaftswunder #ropeway boom #sports installations #urban installations

length 2'000m | rope speed 3m/s
 operation 240 days à 8 hours
 10.000 bending cycles / year

length 1.200m | rope speed 6m/s
 operation 345 days à 16 hours
 100.000 bending cycles / year

What is a Bending Cycle?



Up to 5° deflection: a rope can be considered as „not bended“

More than 5° deflection: rope takes the shape of the support element and has to be considered as „bended“

Reverse bend & ~ 20° deflection: more damage



How to calculate Bending Cycles?



Example of a continuous moving monocable gondola

N	number of bending cycles per year [-]
L	length of the ropeway [m]
v	nominal (usual) speed of ropeway [m/s]
Z	number of sheaves in the ropeway [-]
$t_{hours/day}$	average operation hours per day [-]
$t_{day/year}$	average operation days per year [-]

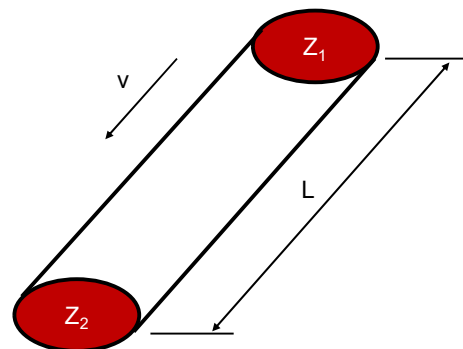

$$N = \frac{3600 \cdot v}{2 \cdot L} \cdot Z \cdot t_{hours/day} \cdot t_{days/year}$$

What is «rope lifetime»?

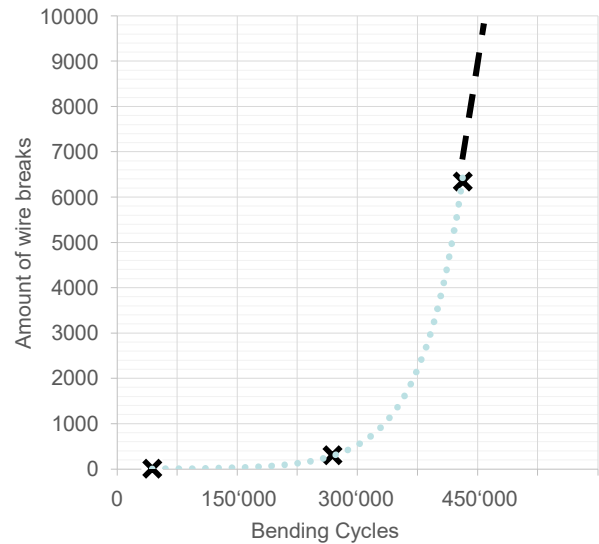
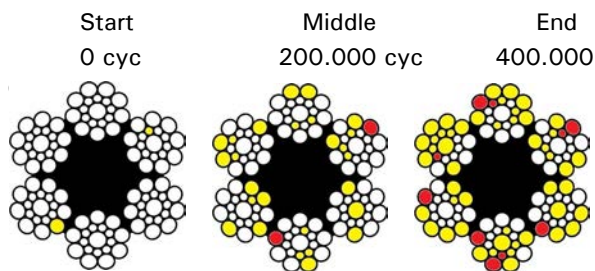

What is «rope lifetime»?



Ropes will develop fatigue, wear and possibly local damage within (long-term) operation

Target: operate ropes as long as possible in safe conditions

Limit: „discard maturity“ – defined conditions under which a wire rope must be replaced

Examples for point of discard

- Local damage (which cannot be repaired any more)
- Safe inspection is no more possible
- Increase of wire breaks will be too fast for feasible future inspection intervals
- development of wire breaks is not safely predictable

We do not want to witness rope failures – we want to keep safe conditions and change a rope on time.



«Overall package» of OITAF SC II Ropes



Visual Inspection
Magnetic testing
Lubrication
Rope lifetime management



- > sustainable use of a rope
- > planable maintenance actions
- > preventive maintenance
- > safe ropeway operation
- > cost efficiency



Thank you for your attention !

Vielen Dank für Ihre Aufmerksamkeit !

Merci beaucoup pour votre attention !

Grazie per la vostra attenzione !



ORGANIZZAZIONE INTERNAZIONALE TRASPORTI A FUNE
INTERNATIONALE ORGANISATION FÜR DAS SEILBAHNWESEN
ORGANISATION INTERNATIONALE DES TRANSPORTS À CÂBLES
INTERNATIONAL ORGANIZATION FOR TRANSPORTATION BY ROPE
ORGANIZACIÓN INTERNACIONAL DE TRANSPORTES POR CABLE

O.I.T.A.F. Seminar Work Committee No. II

Get the best out of your ropes!

Operational aspects influencing the life of strand ropes

Urs BÜRGI, FOT CH
urs.buergi@bav.admin.ch

Innsbruck,
20.04.2023

Operational aspects influencing the life of strand ropes



1. Introduction
2. Operational aspects over time
3. Rope installation
4. Influences during operation
5. Corrosion
6. Summary
7. Basics for a lifetime estimation
(calculation)

1. Introduction

Aspects influencing the life of strand ropes:

Technical aspects

Operational aspects

Maintenance

Design and maintenance of the splice

Influences that cannot be planned

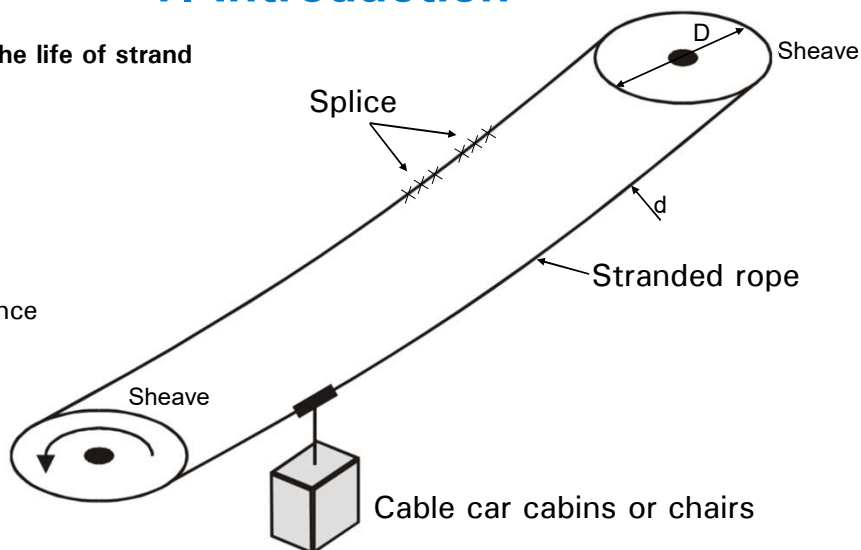

Typical ropeway system

2. Operational aspects over time

- Within the last 20 years, ropes and their field application have developed rapidly
- Most important advantage of a rope is the fact that it reveals an upcoming damage early in time
- If operators recognize the signs of damage, disasters are hardly possible
- Economic development was possible in terms of "bigger, faster, lighter, longer, more efficient, cheaper, etc."
- Number of bending cycles is the main influence on the service lifetime of a rope

Development of number of bendings over the last decades and influence of parameters

Year	Installation Length [m]	Number of Sheaves	Max Speed [m/s]	Operation hours per day	Operation days per year	Max bendings per year	Increase Factor
1953	2390	2	2.5	7	120	3163	1
1999	932	2	5.5	8	270	45888	15
2010	805	2	6	18	365	176288	56
2022	2800	4	7.5	19.25	365	135506	43

3. Rope installation



Abrasion - critical situation, rope too close to the soil



Contact with obstacles - disastrous situation

During rope installation or during operation



Abrasion or crush of the outer wires of several strands

Rope installation and maintenance



Improvised clamp
missing groove
unsmooth surface
unknown sliding force

Forced bending cycles



Deflection sheave
kinking on a diverting
sheave caused by
insufficient orientation
of the sheave

4. Influences during operation

Differences in rope tension forces lead to changes in the lay length, in torque and twist, but also to different transverse forces. Fatigue and abrasion may occur.

Expected different rope tension results from:

- Height difference bottom station - mountain station (haulage rope)
- Difference of rope tension before drive wheel - after drive wheel
- Load condition
- Dynamic forces from acceleration / deceleration
- Meteorological influences (temperature, wind, ice, etc.)

Unexpectedly fast changes may occur from heavy storm with gusts, ice shedding, trees fall on ropes, etc.

It is important to remember not to constantly change the driving speed. A constant driving speed protects the system (oscillations / vibrations) and the rope.

and

The energy in the system depends quadratically from the driving speed.

During operation, grips



Damage

caused by fixed grips after a too late relocation



Negative imprint

of the rope in a fixed grip

Running on rollers and sheaves



Small lining grooves lead to wear at the edges and to twisting

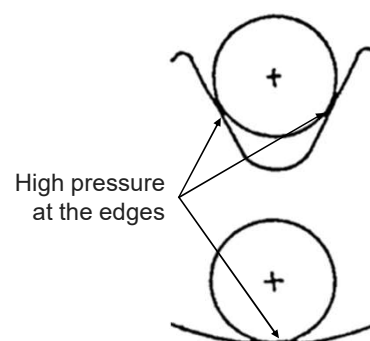

Ropeway drives using a double grooved traction sheave and a counter sheave with different diameters lead to wrapping tension, further unequal abrasion and high stresses in the rope

Running on rollers and sheaves



Roller Damages seriously damage the rope

Running ropes should only touch the soft inserts of rollers, wheels, supports and the clamps

Other contact, with any hard construction elements or flanges of rollers can damage the rope massive

Environmental influences, Lightning strikes



Lightning strikes
not predictable
Not reliably detectable by MRT
recognisable by visual inspection

Environmental influences, Heat on rope



Heat impact on a carrying-hauling rope

Heat of fire
damages the outer wires starting at about 200°C

Failure of the core means that the rope compound loses its support leading to touching strands, wear, corrosion and wire breaks

Lubricants can melt from about 60°C or even lose their properties at about 100°C

Ropes should be kept in motion to prevent local rope sections from heat damages

After exposure to heat on ropes, it is essential that they are assessed by competent persons

Environmental influences, Heat on structures



Heat from sunlight

towers are prevented from heating up by installing sheet-metal panels covering the shafts

Melting of permafrost

leads to deformations, settlements and thus to dis-alignments of the track, to twisting and different lay length, up to rope derailment

Melting of permafrost under drive stations

To protect the permafrost from warming up, foundations are specially insulated against the subsoil to prevent dis-alignments of the track

Derailment and rollovers



Rollover of a hauling rope

Rollover of hauling rope

Rollovers can be caused by vibrations due to emergency braking or wind.

Both track rope and hauling rope should at least be visually inspected after such an incident.

Derailments of funicular ropes can happen quite often.

Especially for concave slope designs, in combination with transverse wind, the rope can fail to lay back into the track rollers.

If derailments mainly happen in the passing loop, the rollers may be insufficiently adjusted or worn. In this case, the rope can be damaged over a very long distance.

In any case of derailment, a competent person should be consulted.

Environmental influences, electrical fields



Moving rope in electromagnetic field generates electrostatic charges of the rope.

At electrically earthed points of contact with the rope, the wires may locally overheat.

Increased wire fracture and reduced lifetime of the rope are the results.

Conclusion

No ropeways near high-voltage powerlines and transmitter-masts.

As a rule, the ropeway control reacts more sensitively than the rope...

Environmental influences, volcanic ashes



After volcano eruption

Ropeways in the vicinity of volcanoes are very exposed to atmospheric influences such as carbon, sulfur, salt water, etc.

Bright ropes instead of galvanized ropes

In this specific environmental condition, the bright ropes shall be advised in respect to the galvanized ropes. In fact, the released sulfur vapors are able to connect with the zinc and create a brittle structure that result in a premature and fast rope failure.



Rope after volcano eruption

Without cleaning, the lifetime of the rope is greatly reduced

5. Corrosion

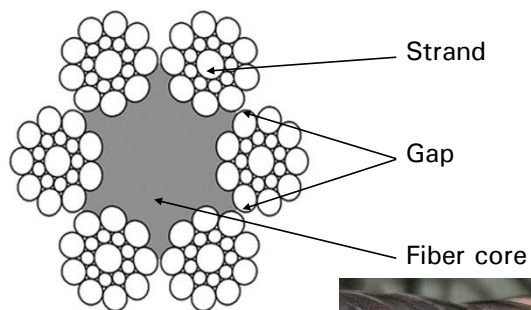

Stranded rope

Cleaning and lubrication
a very important topic
will be covered in a later lecture



Corrosion induced by friction between touching strands

Corrosion



Wire breaks due to corrosion

6. Summary

Aspects influencing the life of strand ropes:

Influences that cannot be planned:

- Failures during installation
- Failures during operation
- Environmental influences
- Corrosion
- Etc.

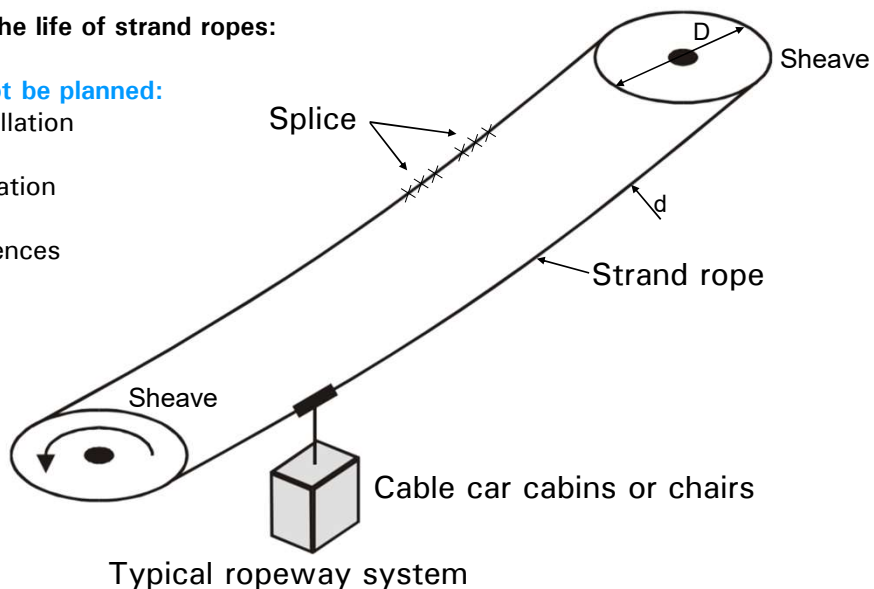

Summary

Aspects influencing the life of strand ropes:

Splice

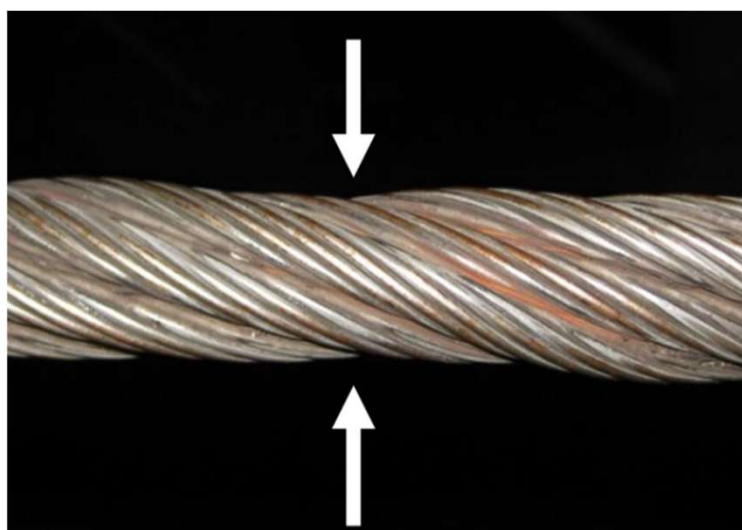

Tuck tail end that needs to be repaired

Summary

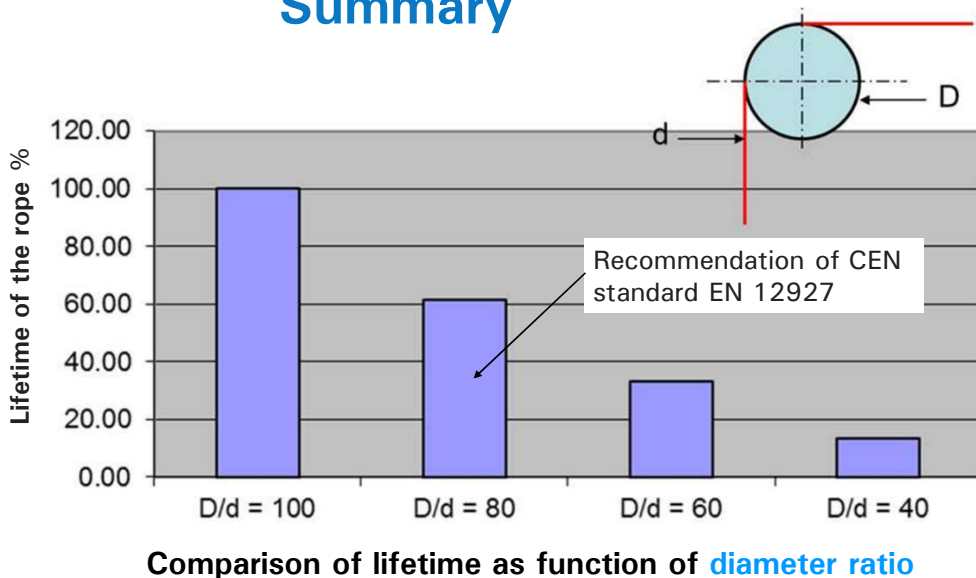

7. Basics for a lifetime estimation (calculation)

Aspects influencing the life of strand ropes:

Maintenance:

- Cleaning / Lubrication

Technical aspects:

- Number of sheaves
- Diameter ration D/d

Operational aspects:

- Bendings per time

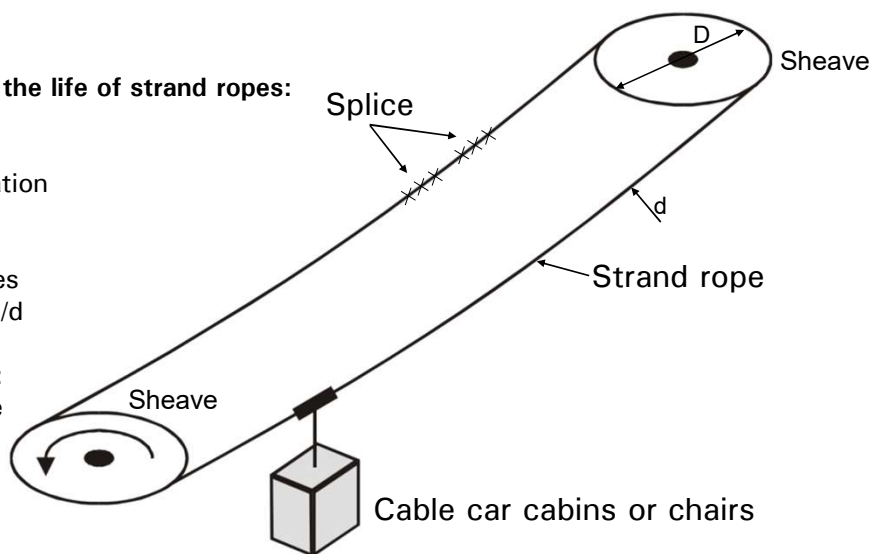

Typical ropeway system



Lifetime estimation of strand ropes



Common wire break due to bending cycles

Thank you for your attention !

Vielen Dank für eure Aufmerksamkeit !

Merci beaucoup pour votre attention !

Grazie per la vostra attenzione !



ORGANIZZAZIONE INTERNAZIONALE TRASPORTI A FUNE
INTERNATIONALE ORGANISATION FÜR DAS SEILBAHNWESEN
ORGANISATION INTERNATIONALE DES TRANSPORTS À CÂBLES
INTERNATIONAL ORGANIZATION FOR TRANSPORTATION BY ROPE
ORGANIZACIÓN INTERNACIONAL DE TRANSPORTES POR CABLE

O.I.T.A.F. Seminar Work Committee No. II

Get the best out of your ropes !

OITAF Recommendation: Lifetime of Ropes

Dr.-Ing. Oliver Reinelt
oliver.reinelt@fatzer.com

20.04.2023



3. Lifetime Estimation "Feyrer Method"

Life time estimation formula

Formula of Prof. K. Feyrer from IFT, University of Stuttgart

$$\lg N = b_0 + \left(b_1 + b_3 \cdot \lg \left(\frac{D}{d} \right) \right) \cdot \left(\lg \left(\frac{S}{d^2} \right) - 0,4 \cdot \lg \left(\frac{R_0}{1770} \right) \right) + b_2 \cdot \lg \left(\frac{D}{d} \right) + \lg(f_d) + \lg(f_L) + \lg(f_E)$$

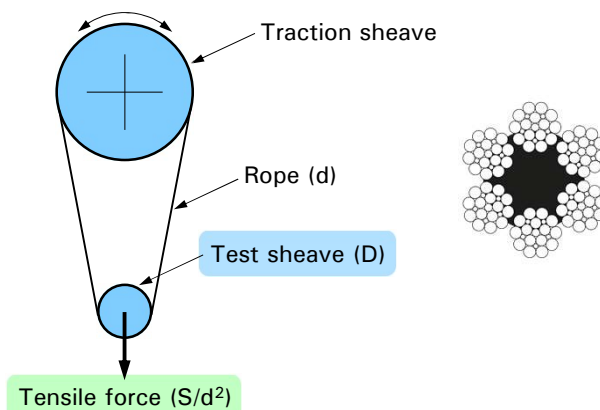

Life time estimation – Bending over sheave test



Lifetime diagram

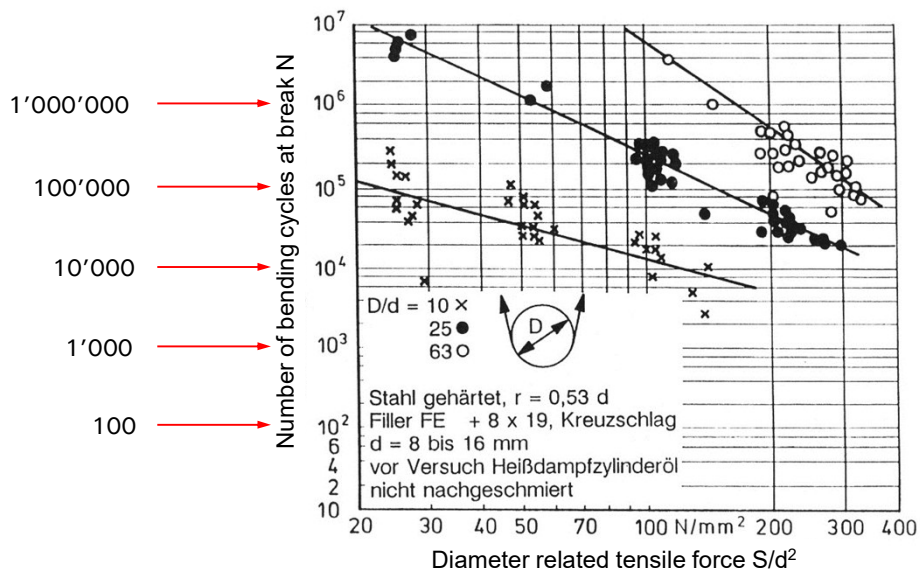

Source: Feyrer, K.: Bruchbiegewechsellzahl von Parallelschlagsellen. DRAHT 35 (1984) 11, S.566-570

Statistic of life time estimation

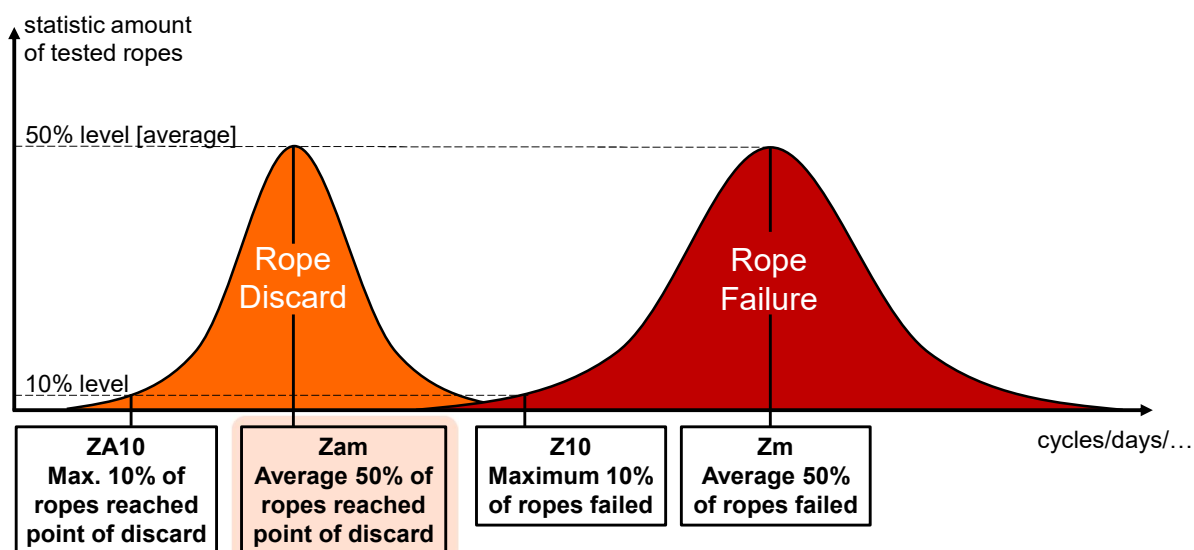



Life time estimation formula

$$\lg N = b_0 + \left(b_1 + b_3 \cdot \lg \left(\frac{D}{d} \right) \right) \cdot \left(\lg \left(\frac{S}{d^2} \right) - 0,4 \cdot \lg \left(\frac{R_0}{1770} \right) \right) + b_2 \cdot \lg \left(\frac{D}{d} \right) + \lg(f_d) + \lg(f_L) + \lg(f_E)$$

The formula is valid with following requirements

- Single bending
- Round steel groove
- Groove radius $r = 0.53d$
- No side deflection of the rope
- Rope generously lubricated with heavy oil or vaseline
- In dry rooms

Results:

- Z_m : Average 50% of ropes broken
- Z_{10} : Maximum 10% of ropes broken
- Z_{am} : Average 50% of ropes reached point of discard
- Z_{a10} : Maximum 10% of ropes reached point of discard



Correction factors F_N

Factors f_N for adapting the calculated values of bending cycles to the real conditions

$$N_{korr} = N \cdot f_{N1} \cdot f_{N2} \cdot f_{N3} \cdot \dots \cdot f_{Ni}$$

▪ f_{N1} : Rope lubrication

- Rope well lubricated: 1.0
- Rope without lubrication: 0.2

▪ f_{N2} : Side deflection

- Not applicable for ropeways

▪ f_{N3} : Groove material

- Steel: 1.0
- Plastic / Polyurethan: $f_{N3} \approx 0.75 + 0.36 \cdot \frac{S/d^2}{D/d} - 0.023 \cdot \left(\frac{S/d^2}{D/d} \right)^2$

Example for f_{N3} :
 - Low load: 1.01
 - High load: 1.24

Factor for rope tensile force

Rope tensile force can vary:

$$S = \frac{Q \cdot g}{n_T} \cdot f_{S1} \cdot f_{S2} \cdot f_{S3} \cdot f_{S4} \cdot f_{S5} \cdot \dots$$

- f_{S1} : Friction in rope drive (roller guide / sliding guide)
- f_{S2} : Efficiency of the rope
- f_{S3} : Parallel ropes
- f_{S4} : Speed / Acceleration
- f_{S5} : Bending with changing tensile force

Calculation for individual situations and positions

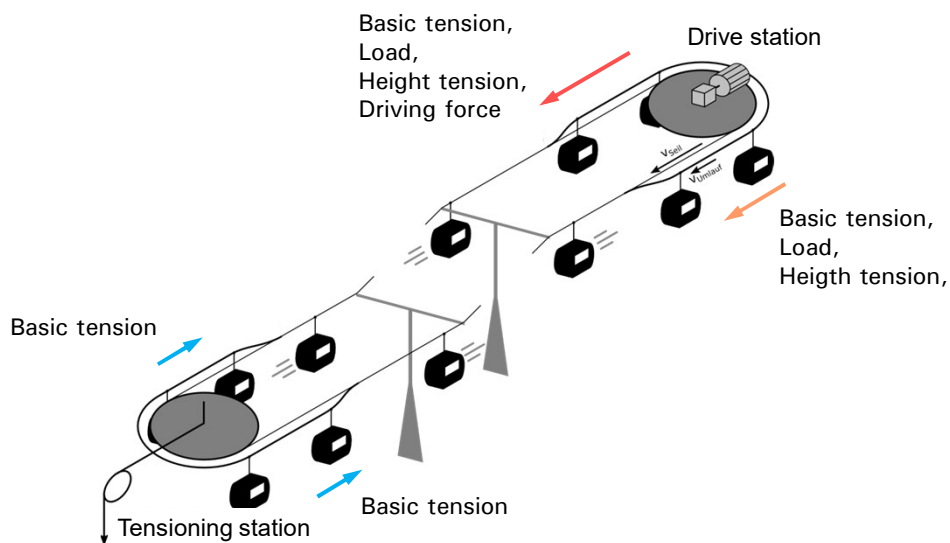

Accumulation of separate lifetime values



Palmgren-Miner Formula:
$$Z = \frac{1}{\sum \frac{w_i}{N_i}}$$



1. Accumulation:
$$Z_{Am\ acc.} = \frac{1}{\frac{w_1}{N_1} + \frac{w_2}{N_2}} = \frac{1}{\frac{1}{N_1} + \frac{1}{N_2}}$$

Working cycles accumulated over 2 sheaves for one operation mode

2. Accumulation:
$$Z_{load} = \frac{1}{\frac{w_1}{N_1} + \frac{w_2}{N_2}} = \frac{1}{\frac{x\%}{N_1} + \frac{y\%}{N_2}}$$

Accumulated working cycles with accumulated portion of operation modes



Example: Mountain Ropeway



Operating hours / year	1'200 bis 3'500
Average Speed	3.5 bis 4.5m/s

Example: Urban Ropeway

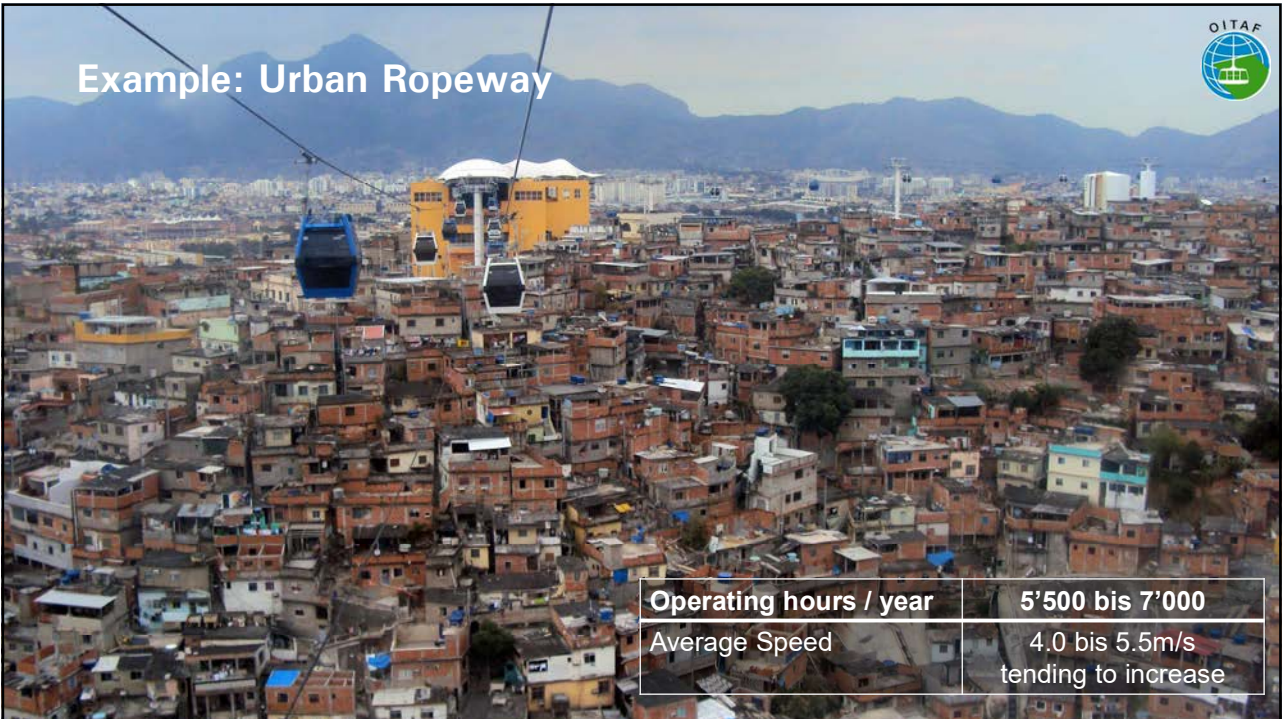

Operating hours / year	5'500 bis 7'000
Average Speed	4.0 bis 5.5m/s tending to increase

Example for Calculation



L	4000 m	L	4000 m
ΔH	600 m	ΔH	50 m
v	4.5 m/s	v	5.5 m/s
d	50 mm	d	50 mm
D	4800 mm	D	4800 mm
Bull wheel		Bull wheel	
F1	420 kN	F1	420 kN
F2	310 kN	F2	330 kN
$\Delta S/S$	0.262	$\Delta S/S$	0.214
FN3	1.3398	FN3	1.3398
Return wheel		Return wheel	
F1 = F2	190 kN	F1 = F2	320 kN
$\Delta S/S$	0	$\Delta S/S$	0
F _{N3}	1.0168	F _{N3}	1.1993

Example: Calculation for Bullwheel (Mountain Ropeway)

Application area

Number of working cycles	(ZA10; ZAm; Z10; Zm)	
Rope construction	(S; F; W; WS)	(Spiral)
Number of strands	(6; 8)	(18; 34)
Rope core	(FC; IWRC; PWRC; ESWRC)	(FC; WSC)
Lay direction	(sZ; zZ)	
Rope tensile force (effective, collective)		S in kN
Diameter sheave, drum and traction sheave		D in mm
Nominal rope diameter (not for d < 6 mm)		d in mm
Nominal strength		R ₀ in N/mm ²
Bending length (not for l < 10d)		l in mm
Rel. tensile force difference		delta S / S = (S - S _u) / S
Simple bendings per working cycle		w sim
Reverse bendings per working cycle		w rev
Comb. fluctuating tension and bendings per working cycle		w _{com}

Zam	126'600
WS	6
FC	
zZ	
S	420
D	4800
d	50
R ₀	1960
l	16000
delta S / S	0.262
w sim	0
w rev	0
w _{com}	1

$$N_{korr} = N \cdot f_{N1} \cdot f_{N2} \cdot f_{N3} \cdot \dots \cdot f_{Ni}$$

$$N_{korr} = 126600 \cdot 1 \cdot 1.3398 = 169612$$

$$N_{korr} = 126600 \cdot 0.4 \cdot 1.3398 = 67845$$

Results:

S/d ² in N/mm ² =	168.0	Number of simple bendings	N _{sin}	556'900
D/d =	96.00	Number of reverse bendings	N _{rev}	254'200
l/d =	320.0	Numb. of fluctuating tension and bendings	N _{sup}	126'600
fS5 =	1.458	Number of working cycles	Zam	126'600
Sequ in N	612380	Discarding number of wire breaks *)	B _{A30}	5
		Opt. rope diameter dopt = d(Zmax)	d _{opt} in mm	163.1
		Minimum rope breaking force	Fmin in kN	1617.00
		Donandt-force (Q = 1%) **)	S _{D1} in kN	939.88

Factor f_{N3} for "soft" groove material

Lubrication factor f_{N1}

Laboratory: 1.0

Reality: 0.4 – 0.8

<https://www.ift.uni-stuttgart.de/forschung/img/feyrer/Seilleb2.xls>

Accumulation for lubrication factor 1.0

Mountain Ropeway

Bull wheel	Z _{Am} = 169'612
Return wheel	Z _{Am} = 12'781'376

Results in Bendingcycles !

Accumulation:

$$Z_{Am\ acc.} = \frac{1}{\frac{1}{169612} + \frac{1}{12781376}} = 167391$$

Result in Round Trips !

Urban Ropeway

Bull wheel	Z _{Am} = 237'806
Return wheel	Z _{Am} = 1'944'359

Results in Bendingcycles !

Accumulation:

$$Z_{Am\ acc.} = \frac{1}{\frac{1}{237806} + \frac{1}{1944359}} = 211890$$

Result in Round Trips !

Accumulation for lubrication factor 0.4

Mountain Ropeway

Bull wheel	$Z_{Am} = 67'845$
Return wheel	$Z_{Am} = 5'112'551$

Results in Bendingcycles !

Accumulation:

$$Z_{Am acc.} = \frac{1}{\frac{1}{67845} + \frac{1}{5112551}} = 66956$$

Result in Round Trips !

Urban Ropeway

Bull wheel	$Z_{Am} = 95'122$
Return wheel	$Z_{Am} = 777'744$

Results in Bendingcycles !

Accumulation:

$$Z_{Am acc.} = \frac{1}{\frac{1}{95122} + \frac{1}{777744}} = 84756$$

Result in Round Trips !

Result in time

$$\text{Round trips per year} = \frac{t \cdot d \cdot v \cdot 3600 \frac{s}{h}}{L}$$

t: Operating hours per day

d: Operating days per year

v: Operating speed [m/s]

L: Length of rope loop [m]

$$\text{Lifetime in years} = \frac{Z_{Am accumulated}}{\text{Round trips}}$$

Result in time

Mountain Ropeway

t: 10 hours per day
 d: 120 days per year
 v: 4.5 m/s
 L: 4000 m

Lifetime

Lubrication Factor 1: 34.4 years

Lubrication Factor 0.4: 13.8 years



Urban Ropeway

t: 18 hours per day
 d: 350 days per year
 v: 5.5 m/s
 L: 4000 m

Lifetime

Lubrication Factor 1: 6.8 years

Lubrication Factor 0.4: 2.7 years



Learnings

What is it good for?

- Useful method for service life estimation
- Optimisation of rope drives
- Evaluation of changes, for example during a rebuild project
- Service life estimation as a basis for determining or adapting inspection intervals
- Service life estimation as a supplement to the results of the MRT

Important: Standards only specify the maximum permissible inspection interval. In case of high utilisation, this interval must be shortened!



Thank you for your attention !

Vielen Dank für eure Aufmerksamkeit !

Merci beaucoup pour votre attention !

Grazie per la vostra attenzione !



ORGANIZZAZIONE INTERNAZIONALE TRASPORTI A FUNE
INTERNATIONALE ORGANISATION FÜR DAS SEILBAHNWESEN
ORGANISATION INTERNATIONALE DES TRANSPORTS À CÂBLES
INTERNATIONAL ORGANIZATION FOR TRANSPORTATION BY ROPE
ORGANIZACIÓN INTERNACIONAL DE TRANSPORTES POR CABLE

O.I.T.A.F. Seminar Work Committee No. II

Get the best out of your ropes !

Service Life Predictions based on MRT

Stefan Messmer

Innsbruck,
20.04.2023



1. Evolution of Damage in Wire Ropes

Evolution of Damage in Wire Ropes (example)

Date	Broken wires	Loss 6xD	Loss 30xD	Loss 500xD
26.12.2019	155	1.6%	4.7%	7.1%
10.6.2016	121	1.6%	1.6%	6.4%
4.6.2013	102	1.6%	1.6%	4.0%
17.6.2010	83	1.6%	1.6%	2.4%
25.4.2007	60	1.6%	1.6%	2.4%
15.6.2004	44	1.6%	1.6%	2.4%
26.6.2001	25	0.8%	0.8%	1.6%
15.6.1998	13	0.8%	0.8%	0.8%
20.6.1995	5	0.8%	0.8%	0.8%
5.5.1992	1	0.8%	0.8%	0.8%

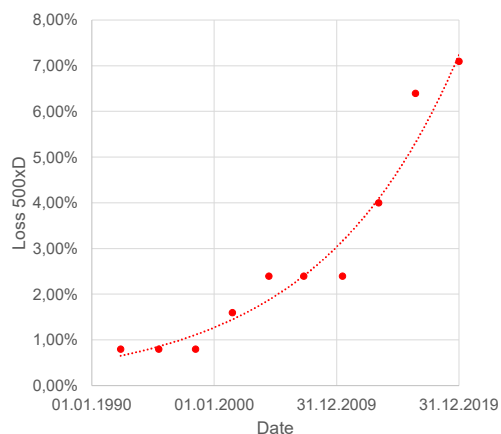

Semi-logarithmic Diagram

Evolution of damage is more or less exponential

A linear trend line approximates the evolution of damage (data from slide 3)

- The trend line in general does not go through an experimental point
- Predictions based on the trend line are not conservative
- and should not be used for safety-relevant predictions (as for example the latest safe date for the next MRT inspection)

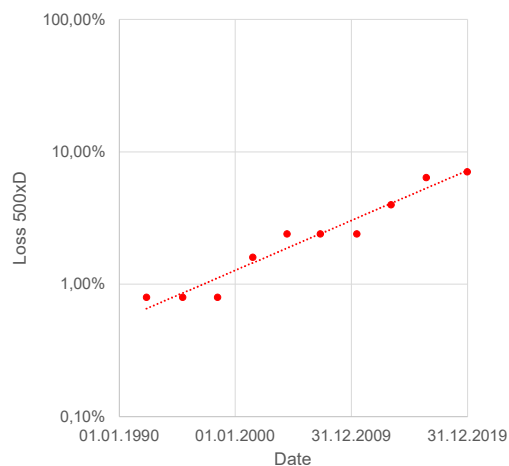



2. Principles of Safe Prediction



Principles of Safe Prediction

- The prediction should start at the current point
- The prediction should reflect the worst scenario imaginable
 - (whatever that means)
- Damage mechanisms may change over time
 - A prediction should take this into account in an appropriate way.
- The loss of cross-section is difficult to predict, it may be necessary to couple it to the evaluation of the number of broken wires
 - The loss of cross-section tends to be proportional to the number of broken wires
 - In the case of few wire breaks, this assumption is on the conservative side

Graphical execution of the prediction

- **Yellow circle:** Starting point
- Draw a line trough the last measurement reflecting the worst scenario
- Draw a second line with increased slope
 - by a safety factor, your experience
- **Green circle:** Next MRT due to legal requirements
- **Red circle:** End of life
- Choose the due date of the next MRT
 - due to egal requirements or
 - before end of life,
 - what ever occurs first
- **Don't use the 40% limit on 500xD for predictions of the latest safe MRT due date**

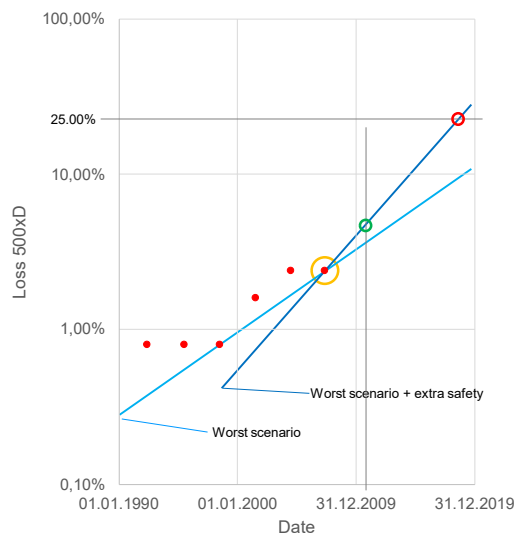

Excel & Co.

- The whole method can be implemented with spreadsheet apps
 - The kernel Excel function of the method is LINESST
 - RGP in German
 - DROITEREG in French
 - REGR.LIN in Italian
 - Help says: «The LINESST function calculates the statistics for a line by using the "least squares" method to calculate a straight line that best fits your data, and then returns an array that describes the line. You can also combine LINESST with other functions to calculate the statistics for other types of models that are linear in the unknown parameters, including polynomial, logarithmic, exponential, and power series. Because this function returns an array of values, it must be entered as an array formula.»
 - You may need to calculate the slope of the regression line as well as its standard deviation
 - You must take into account your personal experience in the form of a safety factor



3. Practical application



Application to example (data from slide 3)

Date	Broken wires	Prediction broken wires	Loss 6xD	Prediction 6xD	Loss Prediction 30xD	Prediction 30xD	Loss Prediction 500xD	Prediction 500xD
26.12.2019	155	191	1.6%	2.5%	4.7%	2.5%	7.1%	10.3%
10.6.2016	121	162	1.6%	2.5%	1.6%	2.5%	6.4%	6.4%
4.6.2013	102	144	1.6%	2.8%	1.6%	2.8%	4.0%	4.2%
17.6.2010	83	123	1.6%	3.3%	1.6%	3.3%	2.4%	4.9%
25.4.2007	60	99	1.6%	3.6%	1.6%	3.6%	2.4%	5.4%
15.6.2004	44	72	1.6%	2.3%	1.6%	2.3%	2.4%	4.6%
26.6.2001	25	54	0.8%	3.3%	0.8%	3.3%	1.6%	3.3%
15.6.1998	13		0.8%		0.8%		0.8%	
20.6.1995	5		0.8%		0.8%		0.8%	
5.5.1992	1		0.8%		0.8%		0.8%	

Remarks on the example (slide 3)

- The broken wires in the most-damaged region were visible
- The operator repaired the rope in this region after the rope inspection of the 26.12.2019
- The results of later MRT's are not shown here, because they are no longer comparable
- The distribution of the rope damage on the 26.12.2019 is shown in the diagram

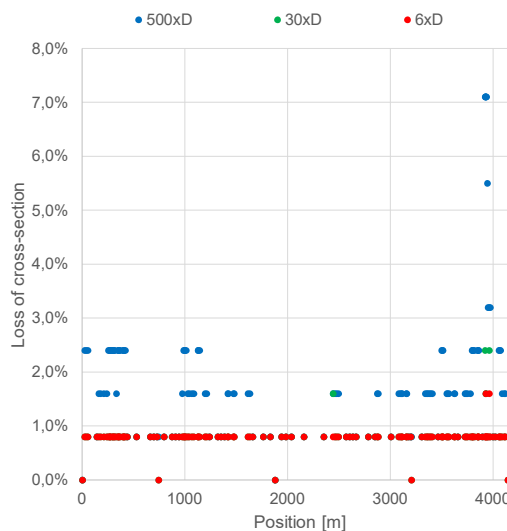

4. Conclusions



Conclusions

- Pro's:
 - We have 20 years of experience with predictions based on MRT results
 - The method safely predicts the evolution of damage over one MRT period
 - We have only a few MRT results exceeding the prediction (< 1 / year with 500 MRT / year)
 - The method is very powerful in estimating safe MRT periods
 - The method handles the distribution of damage correctly
- Con's:
 - Implementation in Excel is complex and error-prone
 - The quality of the prediction decreases with reference length
 - The predictions for the reference length $6xD$ are not very reliable

Thank you for your attention !

Vielen Dank für eure Aufmerksamkeit !

Merci beaucoup pour votre attention !

Grazie per la vostra attenzione !



ORGANIZZAZIONE INTERNAZIONALE TRASPORTI A FUNE
INTERNATIONALE ORGANISATION FÜR DAS SEILBAHNWESEN
ORGANISATION INTERNATIONALE DES TRANSPORTS À CÂBLES
INTERNATIONAL ORGANIZATION FOR TRANSPORTATION BY ROPE
ORGANIZACIÓN INTERNACIONAL DE TRANSPORTES POR CABLE

O.I.T.A.F. Seminar Work Committee No. II

Get the best out of your ropes !

Progress made in MRT technologies and analyses

Ralf Eisinger University of Stuttgart
Stephane Pernot Letscan
Sven Winter ROTEC

ralf.eisinger@ift.uni-stuttgart.de
stephane.pernot@letscan.net
sven.winter@ro-tec.net

Innsbruck,
20.04.2023

What is MRT?

- The rope is strongly magnetised
- Due to the rope structure, a so-called basic signal is then formed
- Deviations from this rope structure then show up as peculiarities in the course of signal

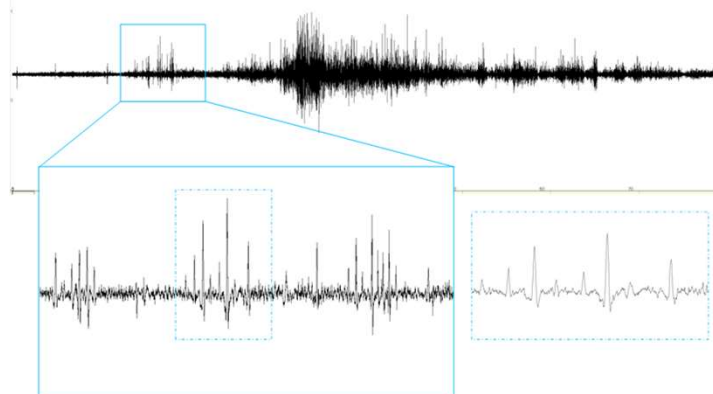

Technical aspects

Magnetic field generation

- Permanent magnet
- Electromagnet

Sensors

- (Classical) coil
 - Change of magnetic field
 - Speed dependent
- Hall effect sensors
 - Absolute value of the magnetic field

Analysis methods

Typical analysis methods

- Manual analysis
- Automatic analysis
- Comparative analysis

Examples of mathematical methods:

- classic peak detection
- FFT (Fast Fourier transformation)
- Wavelet
- Fuzzy method

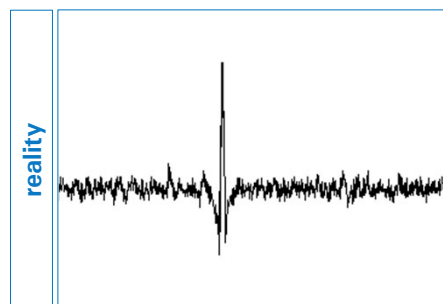
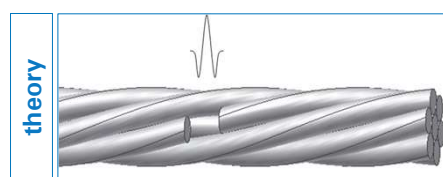

Typical results of signal/data analysis

Typical results of an analysis

- List of broken wires, damaged spots, splice positions
- Cross-section losses for the reference lengths
- Damage trend graph
- Lay length graph

Litzen pro Seil	Anzahl	Drahtdurchmesser mm	metall Querschnitt mm ²	Querschnittverlust %
Drahtseile pro Litze				
Kernkraft	1		18.10	0.52
1 Lage	7		10.18	0.29
2 Lage	7		5.73	0.17
3 Lage	7		9.62	0.28
				0.43

Position	Type	Comment
-3.081 m	splice start 1	
-0.436 m	tuck 1	
0.035 m	broken wire(1)	[2021-07-03]
3.072 m	tucked strand 1'2	
6.026 m	tuck 2	
9.276 m	tucked strand 2'3	
12.536 m	tuck 3	
16.541 m	tucked strand 3'	
38.397 m	tucked strand 4	
44.374 m	tuck 4	

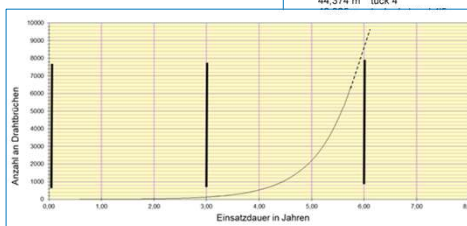

Current developments

Permanent installed MRT for hauling ropes

- Regular automatic measurements possible
- Continuous rope monitoring in order to detect operationally dangerous damage as soon as it occurs.

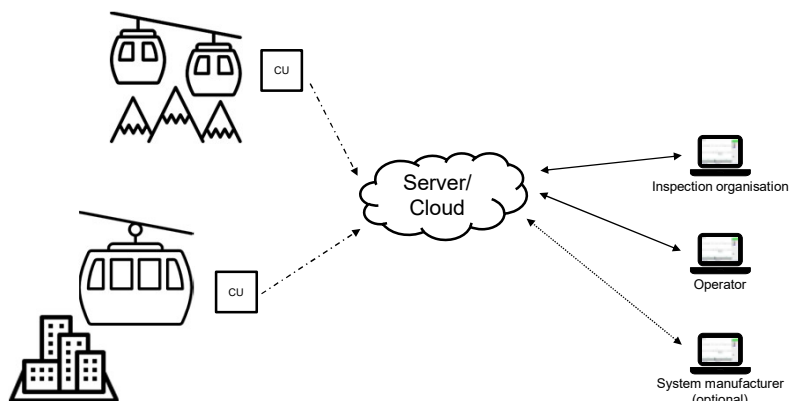

2. Assessing rope damage with Wirelets

- Wirelet scalogram of magnetic signals
 - Time-frequency representation of signal energy
 - Concept of instantaneous frequency

$$W_{\psi}^s(a, b) = \frac{1}{\sqrt{a}} \int_{-\infty}^{+\infty} s(x) \overline{\psi\left(\frac{x-b}{a}\right)} dx$$

- Wirelet signature of wirebreaks

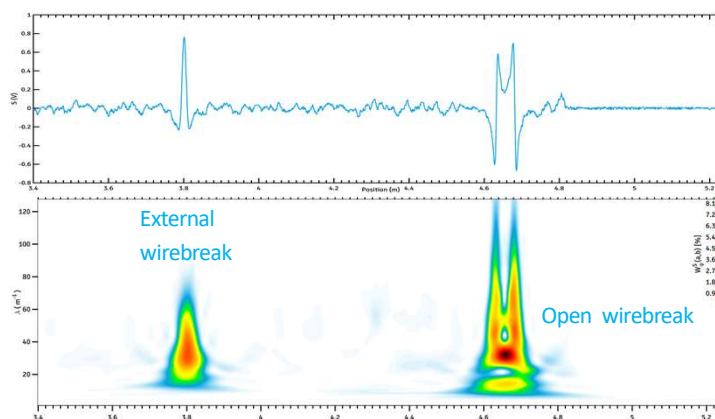

2 Ground signal, fretting and incipient signal

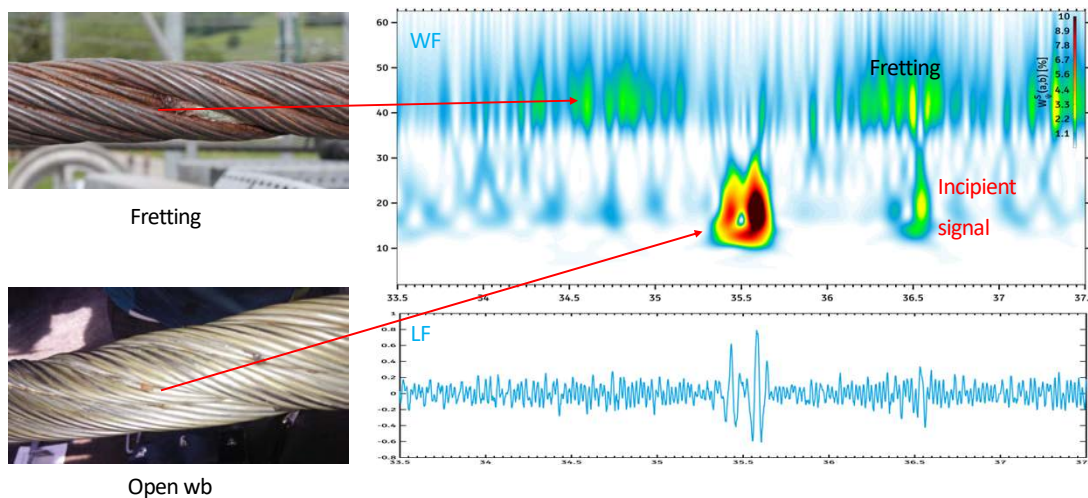

2 Fatigue analysis of an urban ropeway

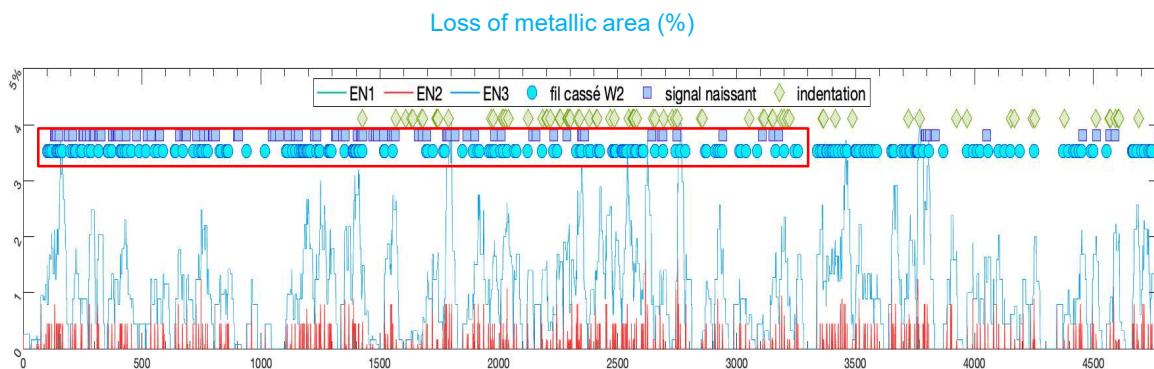

3. Sensor Arrangement

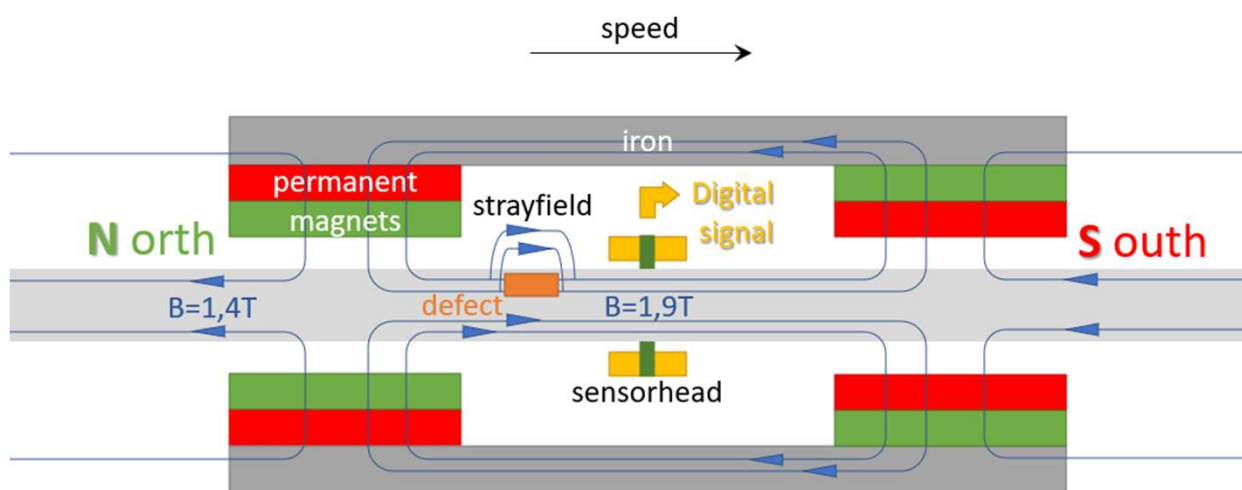



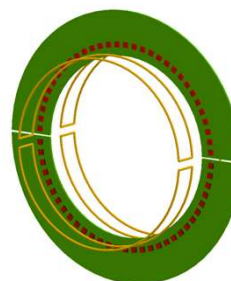

3. Multi Channel Sensor Concept

- Multi channel sensor concept:
 - Up to 48 Hall sensors individually scanned (rope enclosing)
 - 2 induction coils



- 5 outputs:
 - 2 LF channels: LF 1 & LF 2
 - Hall LF channel
 - LMA channel
 - 3D heatmap

3. Multi Channel Sensor Concept

Channel	LF 1 & LF 2	Hall LF	LMA	3D Heatmap
type	Induction coils	Hall sensors	Hall sensors	Hall sensors
				
category	Local Fault	Local Fault	Loss of Metallic Area	Local Fault
Type of defect	Broken wires (Wear, corrosion)	Broken wires (Wear, corrosion)	Wear, Corrosion	Broken wires geometry faults (lay length...)
Advantage	Redundancy: Independent Channels		absolute value	3D representation Location info
Min. Speed	0,3 m/s	0 m/s	0 m/s	0 m/s

3. Multi Channel Sensor Concept

- 3D Heatmap
 - Out of rope enclosing Hall sensors

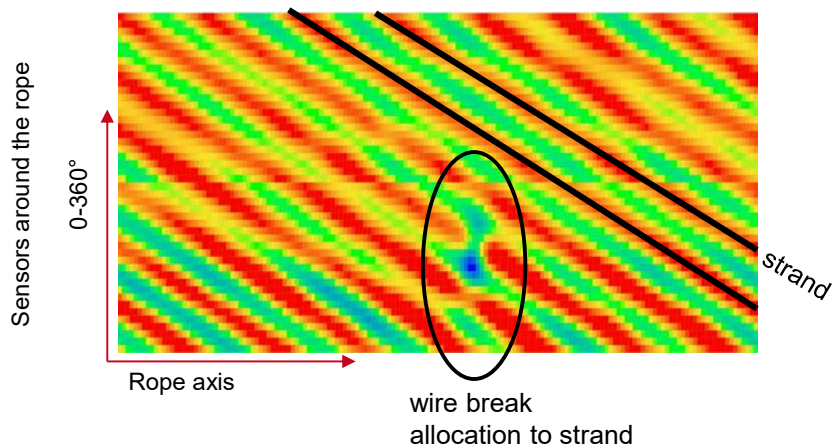

3. Multi Channel Sensor Concept

- 3D Heatmap
 - Out of rope enclosing Hall sensors

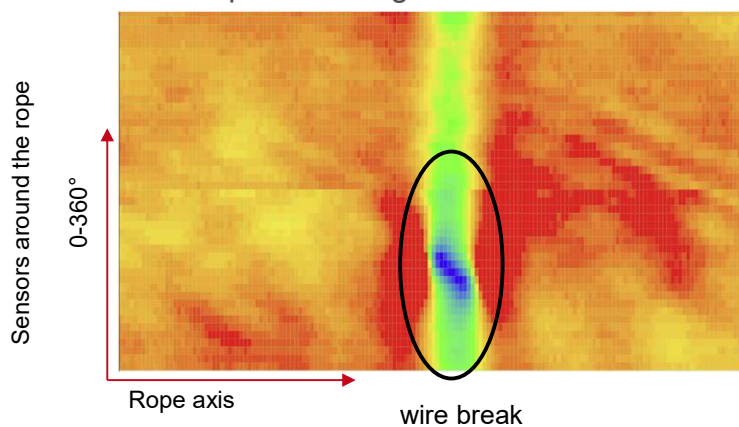

3. Multi Channel Sensor Concept: Lay length

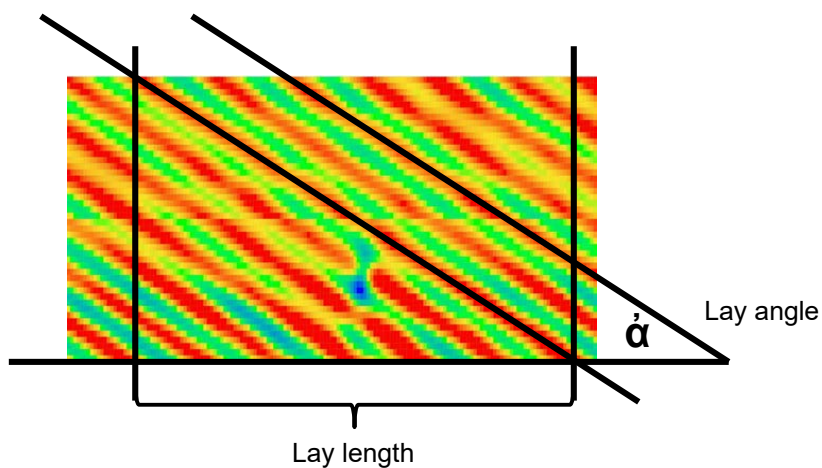

3. Multi Channel Sensor Concept: Lay length

Calculated Lay length along the rope



3. Multi Channel Sensor Concept: strand gap

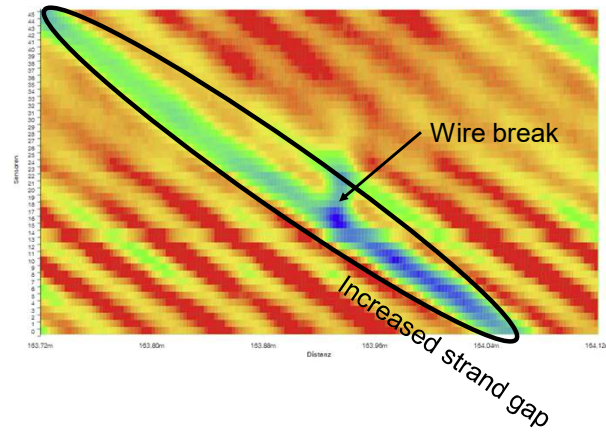

Thank you for your attention !

Vielen Dank für eure Aufmerksamkeit !

Merci beaucoup pour votre attention !

Grazie per la vostra attenzione !



ORGANIZZAZIONE INTERNAZIONALE TRASPORTI A FUNE
INTERNATIONALE ORGANISATION FÜR DAS SEILBAHNWESEN
ORGANISATION INTERNATIONALE DES TRANSPORTS À CÂBLES
INTERNATIONAL ORGANIZATION FOR TRANSPORTATION BY ROPE
ORGANIZACIÓN INTERNACIONAL DE TRANSPORTES POR CABLE

O.I.T.A.F. Seminar Work Committee No. II

Get the best out of your ropes !
Methods for improving rope life

Peter Huber

Innsbruck,
20.04.2023

1. Methods of relubrication 1916

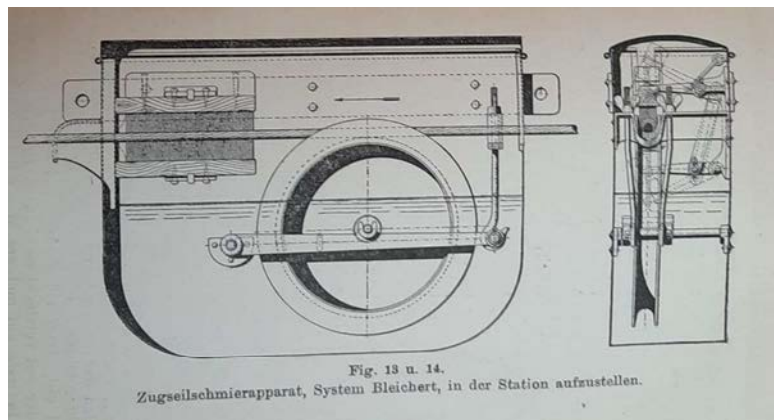

1. Methods of relubrication 1929

Mechanical Oiler from 1929 at funicular in Stuttgart



1. Chair Lift



Source: www.wikipedia.org

1. Ungalvanized rope 1950



1. Galvanized rope 1960

Since the 1960s, galvanized ropes became more and more common.

Corrosion was no longer a problem

Due to the contamination of the ropeway and passengers, the primary lubricant and relubrication were increasingly reduced or neglected.

Rope lubrication got a negative image

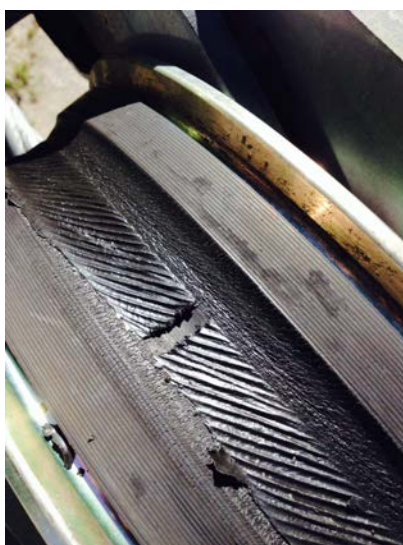

1. Galvanized rope 1960

Due to unsuitable relubricant, the roller rubbers were dissolved and damaged.

As a result, a large number of the track rollers had to be replaced prematurely.

For this reason, the operators have significantly reduced or completely stopped relubrication.



2. Lack of basic lubrication in today's haulage ropes

Very low basic lubrication for a new rope



At rope opening after 4 years of operation



After two years of operation, there is already significant corrosion on the strands



3. Primary lubrication and relubrication requirements

Primary lubrication:

- **Uniform** distribution of the lubricant during stranding
- For good basic lubrication, approx. 30 g/sq. m. of wire surface should be applied.
- For a 40 mm rope (rope weight 6kg/m), it is approx. 75 g per meter of rope

Relubrication:

- Relubrication should be frequent or permanent during operation
- The relubricant must be compatible with the base lubricant
- The relubricant should be creepable so that it reaches the inside of the strand.
- The relubricant must be compatible with the roller rubbers

4. Rope lifetime and amount of lubrication

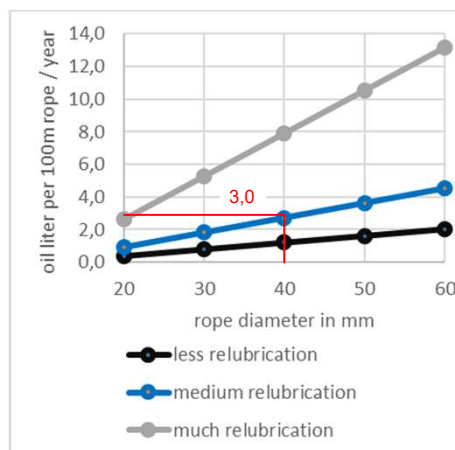
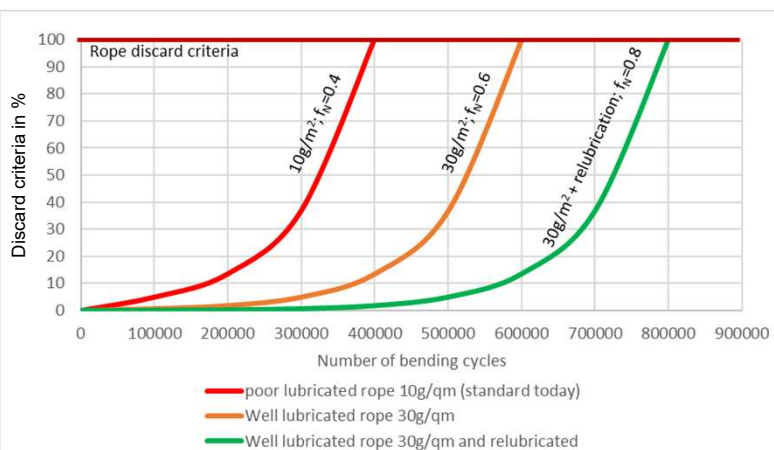

5. Praxis example of rope lubrication

Poor lubricated rope: 0 bending cycles; 2017



5. Praxis example of rope lubrication

Poor lubricated rope:
315.000 bending cycles; 2022

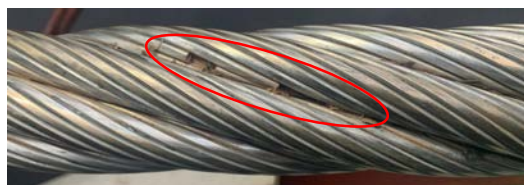

6. Methods of relubrication

Interval relubrication: Result of the same rope after well relubrication



6. Methods of relubrication

Permanent oiling dependent on rope speed

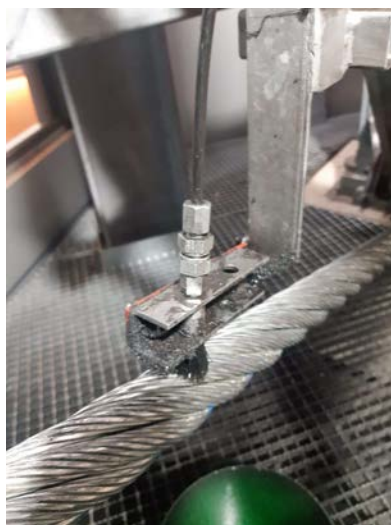

7. Rope lifetime and costs depending on lubrication incl standard = 10 g/m² lub., good = 30 g/m² lub

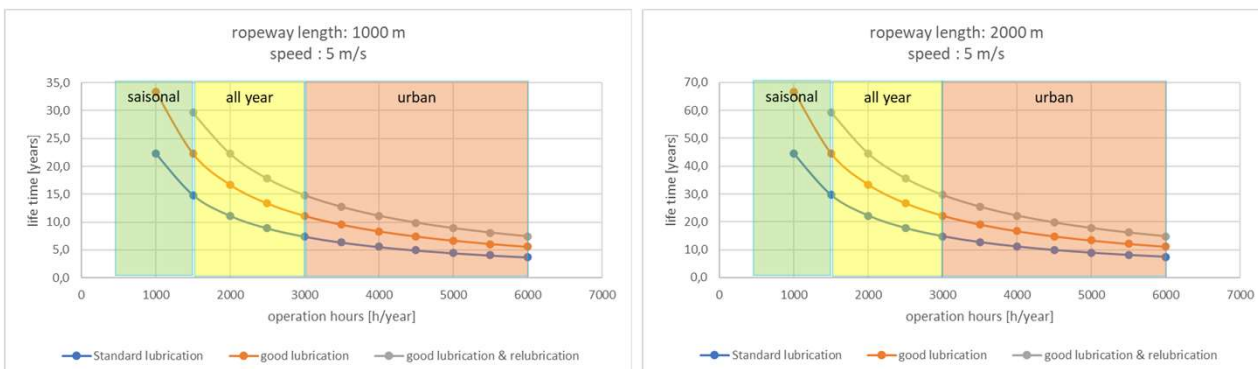

Rope cost: 500.000,- EUR; Standard lubrication: life time 10 years
 4000m rope; 300day a 10h Rope Cost: 50.000,- EUR/year
 Relubrication : life time 20 years
 Rope Cost: 25.000,- EUR/year

Thank you for your attention !

Vielen Dank für eure Aufmerksamkeit !

Merci beaucoup pour votre attention !

Grazie per la vostra attenzione !



ORGANIZZAZIONE INTERNAZIONALE TRASPORTI A FUNE
INTERNATIONALE ORGANISATION FÜR DAS SEILBAHNWESEN
ORGANISATION INTERNATIONALE DES TRANSPORTS À CÂBLES
INTERNATIONAL ORGANIZATION FOR TRANSPORTATION BY ROPE
ORGANIZACIÓN INTERNACIONAL DE TRANSPORTES POR CABLE

O.I.T.A.F. Seminar Work Committee No. II

Get the best out of your ropes !

Methods for improving rope life

Mathieu WEISS (STRMTG, FR)
mathieu.weiss@developpement-durable.gouv.fr

Innsbruck,
20.04.2023

1. Rope installation & splice

- Choice of rope
 - Finish of wire as needed (environmental conditions)
- Installation of a rope
 - Organize a correct transport, storage and installation of a rope
- Replacement of the rope
 - Check interfaces, for example groove diameter
- Splice : see presentation of **Focus on Splices**
Bruno LONGATTI (IKSS, CH)

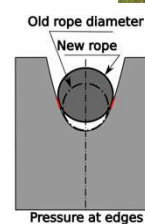
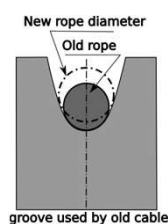
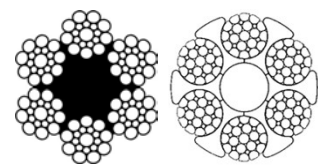
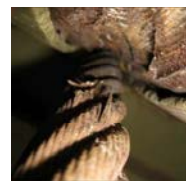

2. Operation/Maintenance

- Consider sustainable rope operation parameters:
 - Speed of operation
 - Avoid unnecessary cycles

- Following other components of installation
 - Alignment of line
 - Follow state of lining of sheaves and rollers (see slide 1)
 - Follow state state of grip
 - Relocate fixed grips

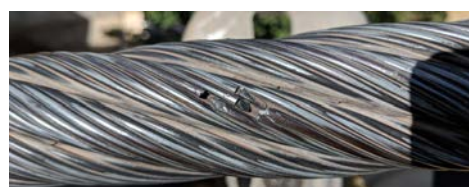

3. Use VI

- VI allows the detection of local defects, before they become broken wires
 - Immediately after a known event, as derailments, clamp sliding, etc.;

You can take actions before, by grinding surface in some case for example:



3. Use VI

- VI allows the detection of local defects, before they become broken wires
 - At the normal periodicity for undetected event, as lightning strikes, scratches and notches, for examples.

You can take actions before, by grinding surface in some case for example:



4. Use MRT

- MRT allows to follow:
 - Development of wire breaks;
 - Density of local damage accumulation;
 - Select the right MRT periodicity for next test.

(see presentation of **Service life predictions based on MRT in practice**, Stefan MESSMER (IWM AG, CH))

You can take actions on maintenance, for example on relubrication, or programme repair, by strand replacement or a complete section of a rope

Both VI and MRT informations allow to renew the rope in time before it is too late

Thank you for your attention !

Vielen Dank für eure Aufmerksamkeit !

Merci beaucoup pour votre attention !

Grazie per la vostra attenzione !

O.I.T.A.F. Seminar Work Committee No. II

Get the best out of your ropes !

Long splice lifetime

Bruno Longatti, IKSS

Innsbruck,
20.04.2023

Content themes about a long splice

- Basics
- Functionality of a long splice
- Execution of a long splice
- Discard criteria's
- Knowable damages on splices
- Maintenance
 - Inspection + Servicing
 - Shortening
 - Repair within splice length
 - Repair in the free rope length
- Splice and Rope lifetime
- History / Future



Side 2

Basics

Production of a long splice is manual work (hand work)!

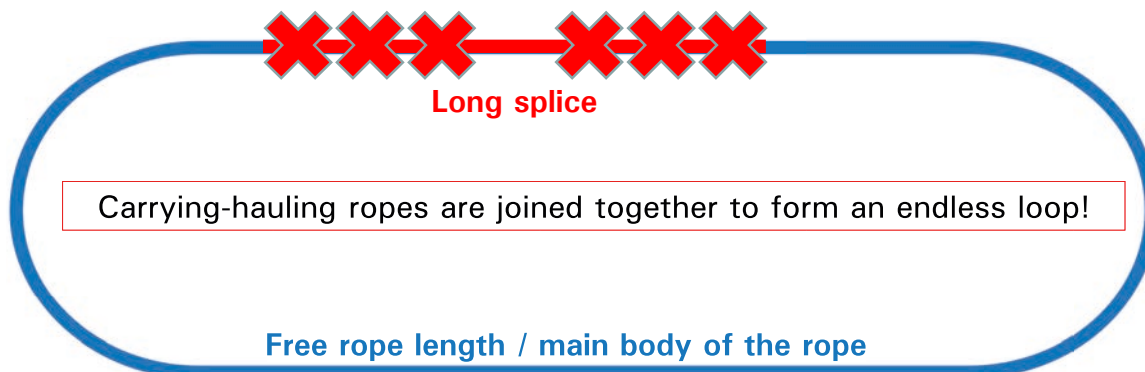

The **splice** is the "weakest" area in a rope loop in terms of **fatigue**!

Basics

More Details about the production of a long splice can be seen:



youtube film:
„Wo ist der Knoten in
einem Seil“



Basics

Long splice acc. EN 12927

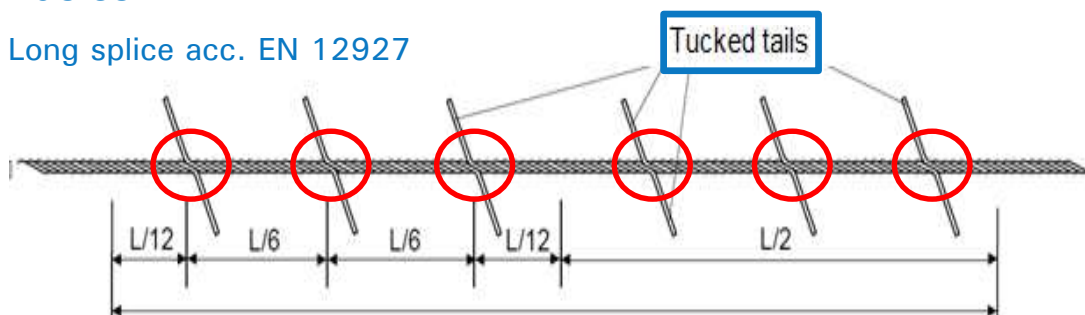

Tuck: location in a splice where 2 opposite outer strands of a rope enter into the core
 → **At least as many tucks as strands**

Tucked tail: area in a splice where 1 outer strand (properly wrapped) replaces the rope core

→ **At least twice as many tuck tails as strands**

Basics / Hazard scenarios

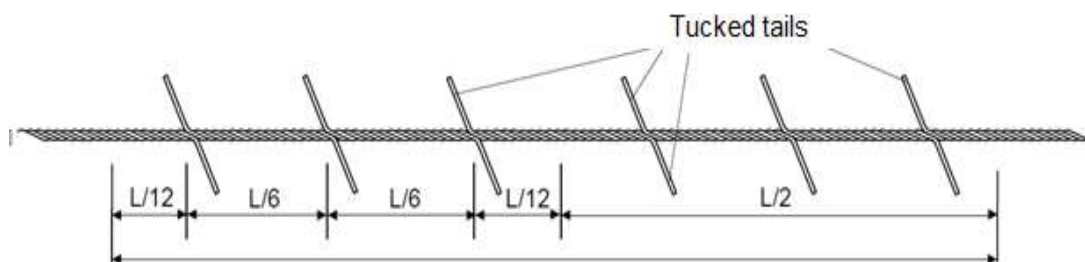

Long splicing of 6 strand haulage, carrying-hauling and carrying-hauling ropes for ski-tow:

- the **risk of deformation and slipping of the spliced rope ends** may be reduced by a correct correlation of geometrical characteristics of the two ropes connected by the splice, by selecting the splice geometry in accordance with this standard and by selecting the correct auxiliary (wrapping) material;
- the **risk of an insufficient attachment of the grip** to the rope may be reduced by applying limitations to the diameter of the splice in accordance with this standard;
- **Diameter reduction** in the splice area may lead to an **increase of stresses** in the rope.

Functionality of a long splice

Frictional connection between the strands surrounding the rope, the winding material and the inserted strand

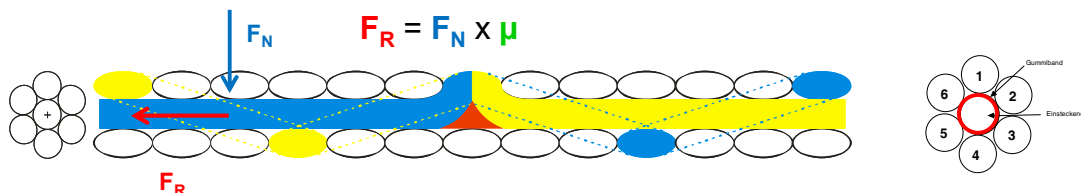

▲ F_N dependent on:

- Rope tension
- Winding angle

▲ F_R dependent on:

- F_N
- μ Friction coefficient of friction between outer strands – wrapping material - inserted strands

Execution of a long splice (acc. EN 12927)

Variables:

Total length of a long splice

Length of tuck tails

Diameter of tucks
whole splice area

Waviness within the splice area

Splice version

Wrapping material of the tuck tails

Splice tucks execution type

Type of splice tuck supports

Type and design of the inserts

Recommendations:

≥ 1200 or 1500

≥ 60 or 100

$\leq +8\%$ (10%) of nominal \emptyset
 $\geq -10\%$ of nominal \emptyset

$< 6\%$ of nominal \emptyset

no requirements

no requirements

no requirements

no requirements

no requirements

Execution of a long splice (acc. EN 12927)

Maximum safety factor ≤ 15

Overall length $\geq 1200 \times \text{rope-}\varnothing$,

Length of tucked tails $\geq 60 \times \text{rope-}\varnothing$

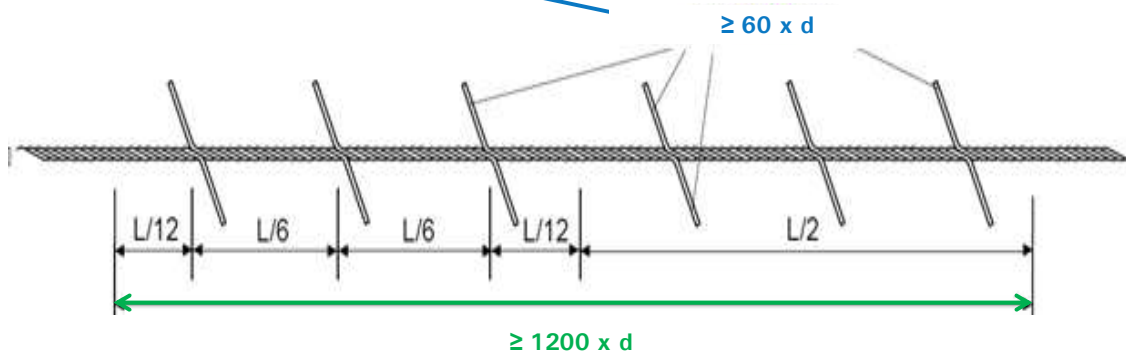

Execution of a long splice (acc. EN 12927)

$15 < \text{maximum safety factor} \leq 20$

▲ Overall length $\geq 1500 \times \text{rope-}\varnothing$,

▲ Length of tucked tails $\geq 100 \times \text{rope-}\varnothing$

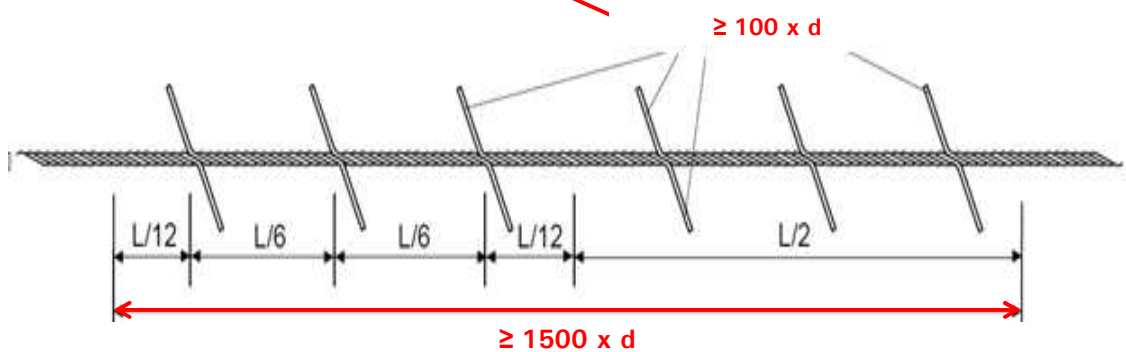

Execution of a long splice

Standard specifications according EN 12927

- The tensile safety of the rope does not exceed 20 in the splice area and is not less than the values set out in EN 12930.
- Splicing shall be performed by a skilled person, the “splicer”, following a written procedure. The splicer shall have knowledge and practical experience and shall be capable of assessing the quality of the splice in relation to the requirements of this standard.
- The rope splice shall not contain any added magnetic material.
- If there are two or more splices, they shall be properly recognizable and they shall be traceable by means of the splice documents.

Side 11

Execution of a long splice

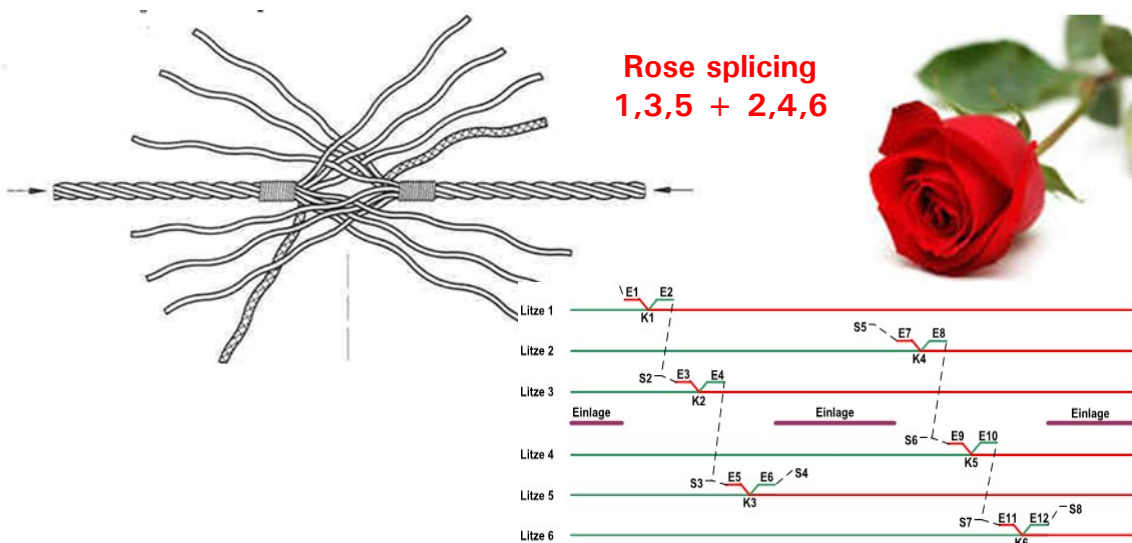

Side 12

Execution of a long splice

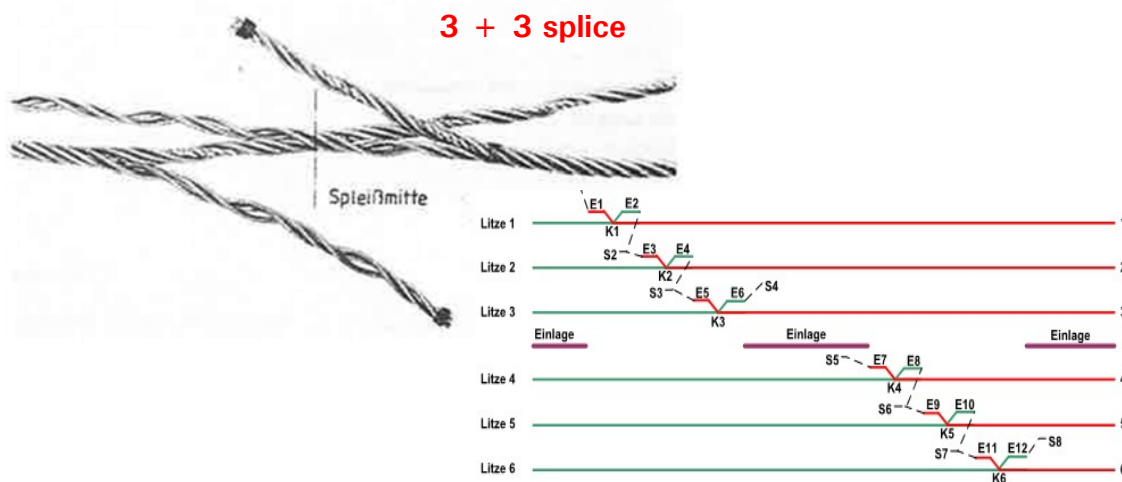

Side 13

Execution of long splice tucks

Interlaced cross tuck

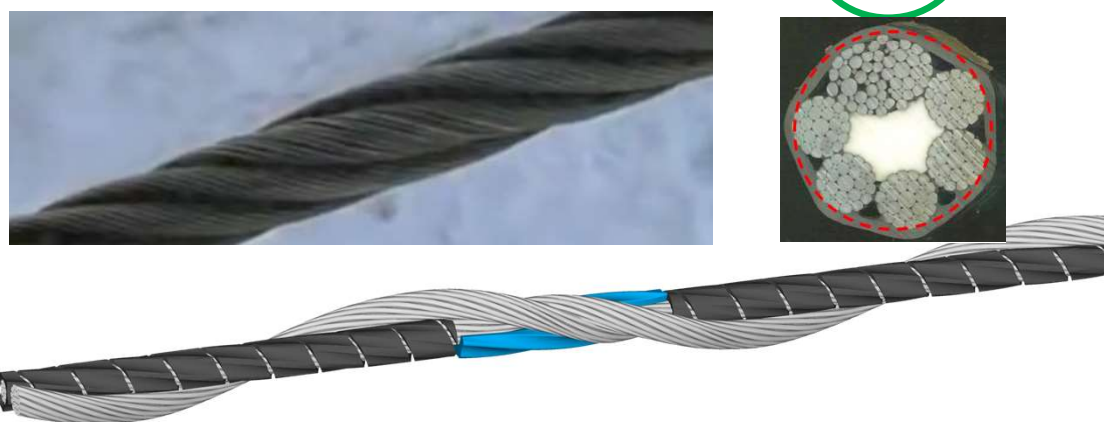

Side 14

Execution of long splice tucks

Parallel tucks

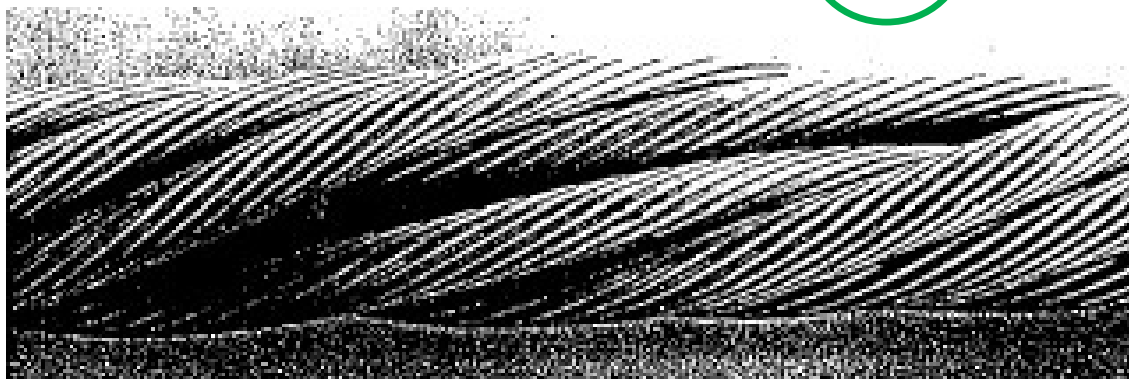
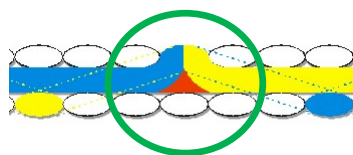

Other, lesser-known types of tucks are also used!

Execution of splice tuck supports

Preconditions:

- Various tuck supports «dolls» are used!
- Importance of wrapping material winding start!
- No kinking of strands or wires
- Good lubricated



Goals:

- Lowest possible pressure between strands
- Low friction corrosion
- Reduce risk of wire breaks at an early stage

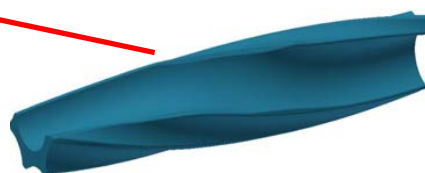

Execution of the tuck tail wrapping

Preconditions:

- Various wrapping materials are used for doubling up the inserted tuck tails and creating friction
- Wrapping material is durable, flexible

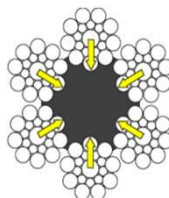

Ideal internal radial forces



Goals:

- Preventing metallic contact between the inserted tuck tails and the outer strands
- Reduce risk of fretting and wire breaks at an early stage

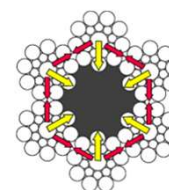

Bridging



Side 17

Execution core portion between tuck tail ends

Preconditions:

- Various inserts are used!
- Diameter of the inserts is big enough
- Insert is durable
- Tuck tail ends are close to each other or to the insert

Goals:

- Reduce risk of shrunken tuck tail ends
- Reduce risk of fretting and wire breaks at an early stage

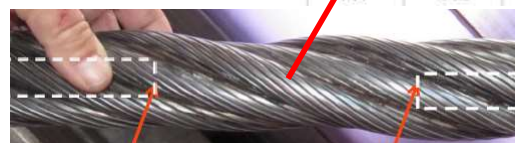

Attention: Damages at tuck tail ends are difficult to repair!

Side 18

Discard criteria's for long splices (acc. EN 12927)

Loss of metallic area:

- The same than in the main body of the rope

Class of rope	Maximum permissible loss of metallic cross sectional area	Reference length
Stranded ropes	40 %	$500 \times d$
	10 %	$30 \times d$
	6 %	$6 \times d$

Additional:

- Value on tucks is $> 1,10$ (1.08) times nominal- \emptyset (for detachable grips)
- Rope- \emptyset is reduced more than 10 % of the nominal- \emptyset
- Waviness between the tucks is higher than 0,06 times the nominal- \emptyset
- Visible fretting between the strands at shrunken tuck tail ends

Attention:

- Known broken wires on tuck tails do not count!

Repairing actions are recommended, if any discard criteria is reached!

Knowable damages on Splices

tucks

- Deformed tucks, inappropriate support
- Lose wires, fretting, wire breaks



Shrunken tuck tail ends

- Shrunken tuck tail ends
= Risk of malfunction of grips
- Fretting, wire breaks



Area above the tuck tails

- Uneven strand distribution, malfunction of the wrapping material
- Reduced Diameter = Fretting / Risk of malfunction of grips



Maintenance

Inspection + Servicing

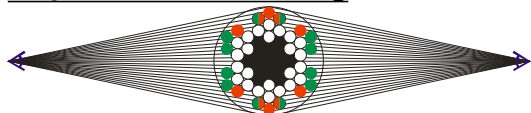

Repairs within the splice length

Splice shortening



Repairs in the free rope length

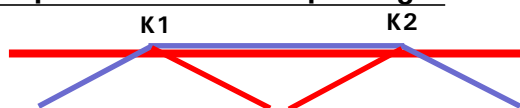

Side 21

Inspection and servicing

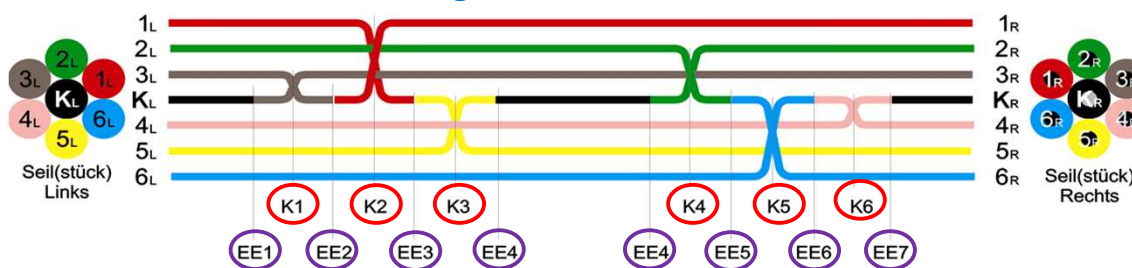

General:

Damages, diameter, waviness

Cleanliness for visual inspection

Tucks:

Damages, wire breaks, loose wires, fretting, diameter, deformations

Relubrication

Tuck tail ends:

Wire breaks, loose wires, fretting, diameter

Tuck tails:

Damages, fretting, diameter

Repairing actions are recommended, before any discard criteria is reached!

Side 22

Splice repair: Rope shortening = splice refreshing

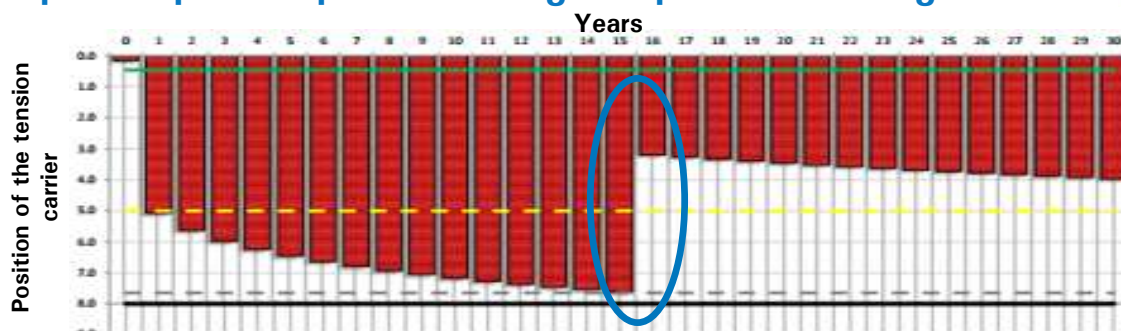

- Every rope lengthens permanently during its service life!
- Shortening can be used to eliminate this lengthening!
- Therefore, it is important to plan:
 - First shortening should be at the same time with a first splice repair due to fatigue!
 - Don't use up the entire available shortening length, it's missing for later repair!

Side 23

Splice repairs: new supports, inserts, wrappings

Goal: Eradication of inappropriate conditions

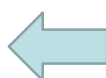
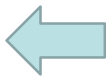
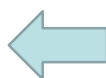

Side 24

Splice repair: new inserted additional strands

Goal: Repair of a bigger damage with strands within the splice length

Variant 1: One or two strands are inserted and ends within the splice length



Variant 2: One or two strands are inserted and ends outside of the splice

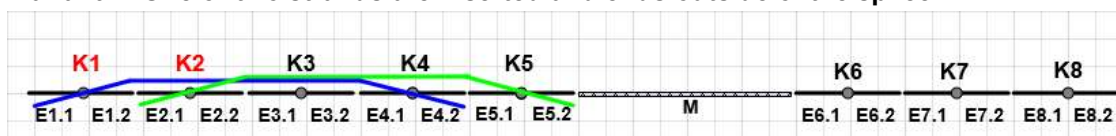

Attention: Keep remaining strands from the initial splicing, they could be useful for such a repair!

Splice repair: Inserted repair peace

Goal: Repair of a big damages **within or near of the splice**

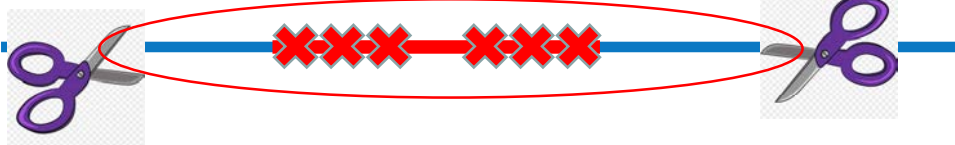

Splice or splice with damage outside of the splice have to be cut out!

A new repair peace is to splice in!

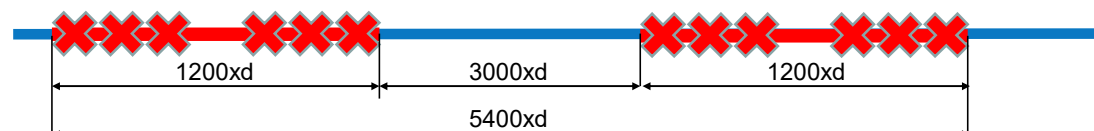

Attention: We have now 2 splices (double work and risk)!
Position of any splice should not be near of an end fixing or clamp!

Repairs in free rope length: exchanged strands

Goal: Repair of a bigger damage in the free rope length



Variant 1: One strand are inserted in the free rope length



Variant 2: Two strands are inserted in the free rope length

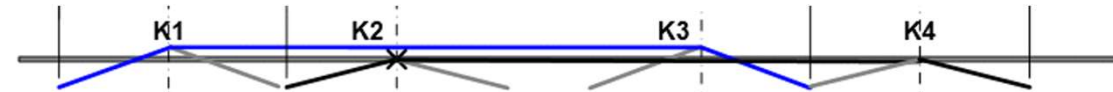

Side 27

Repairs in free rope length: Repair peace

Goal: Repair of a big damages in the free length



Splice or splice with damage outside of the splice have to be cut!

A new repair peace is to splice in!

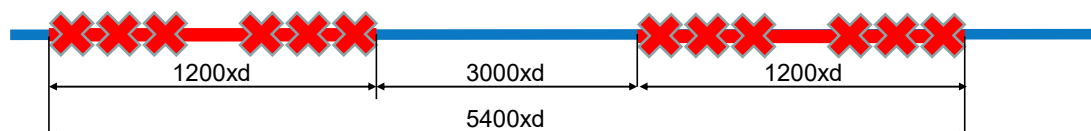

Attention: We have now 2 splices (double work and risk!)
Position of any splice should not be near of a cabin!

Side 28

Splice lifetime

Important for a long splice lifetime are:

- No damages from incidents
- suitable, diameter-stable wrapping material
- suitable, diameter-stable material for tuck support
- Diameter of tucks as big as possible / Place for the additional strand!
- Good support lubrication and relubrication of the tucks
- suitable, diameter-stable material for inserts between the tuck tail ends
- Good, experienced hand work

➔ Enables bending cycles in the range of 200' – 400'000 BW until repair becomes necessary!

Regular inspection and relubrication of the tucks are indispensable!

Rope lifetime (free Example)

Important for a long rope lifetime are:

- The lifetime of a splice, without shortening, have to be at least ~ 0.4 as a normal rope lifetime!
- Short a rope never too much, a part of the length is necessary for later shortenings / splice refreshing's or repairs!
- Mostly, it is only possible to make two appropriate rope shortenings.



- If you take care of the splice, you can use the whole rope for long time and save money!

History / Future

1931: Publication H. Overlach, TU Karlsruhe

- Force curve over tuck tails
- Minimum length of tuck tails $100 \times d$
- Minimum length of the long splice $1200 \times d$

1970 - 2020

- Optimizing of wrapping material, the tuck supports and inserts
- Reduction of the tuck tail length (USA $30 \times d$ / CH $50 \times d$)
- 2004 New EN standard required tuck tail length of $60 \times d$

2022

- Up to 50% length reduction of a long splice acc. to EN 12927 (proven, evaluated for each individual splice, with EN certificate)

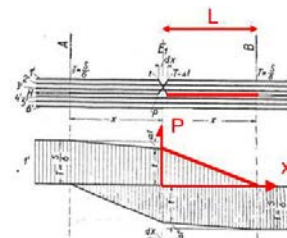

Side 31

Thank you for your attention !

Vielen Dank für ihre Aufmerksamkeit !

Merci beaucoup pour votre attention !

Grazie per la vostra attenzione !