



ROMA 1957
PARIS 1963
LUZERN 1969
WIEN 1975

MÜNCHEN 1981
GRENOBLE 1987
BARCELONA 1993
SAN FRANCISCO 1999

INNSBRUCK 2005
RIO DE JANEIRO 2011
BOLZANO-BOZEN 2017



OITAF

Séminaire / *Seminar*

Grenoble – 27/04/2022



ROMA 1957
PARIS 1963
LUZERN 1969
WIEN 1975

MÜNCHEN 1981
GRENoble 1987
BARCELONA 1993
SAN FRANCISCO 1999

INNSBRUCK 2005
RIO DE JANEIRO 2011
BOLZANO-BOZEN 2017



Séminaire OITAF / *OITAF Seminar*



Transport par câbles : sécurité au top



Ropeways: top level of safety



Seilbahnen: auf höchstem Sicherheitsstand



Impianti a fune : sicurezza al top



Transporte por cable: al más alto nivel de seguridad



ROMA 1957
PARIS 1963
LUZERN 1969
WIEN 1975

MÜNCHEN 1981
GRENOBLE 1987
BARCELONA 1993
SAN FRANCISCO 1999

INNSBRUCK 2005
RIO DE JANEIRO 2011
BOLZANO-BOZEN 2017



Introduction

by **M. Joyeusaz**

Introduction

THE ORIGIN....

- **1834** Wilhelm Albert invents and produces the first rope with steel strands



- **1837** Wurm in Vienna invents the first wire drawing machine

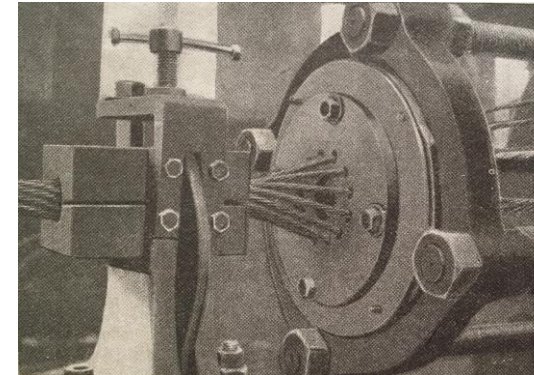

- **1884** Latch & Bachelor manufacture smooth ropes, called locked coil ropes



Introduction

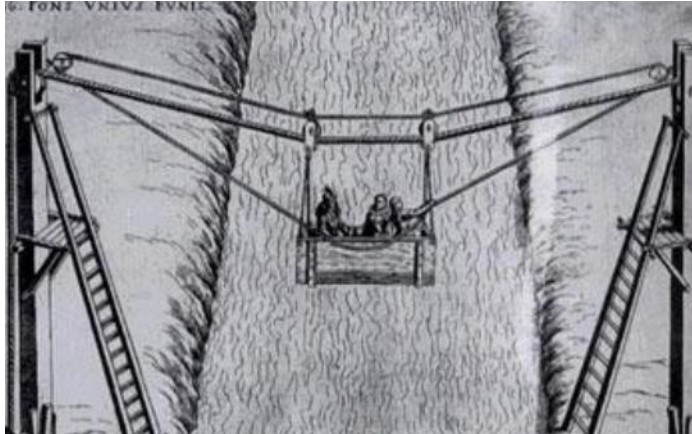
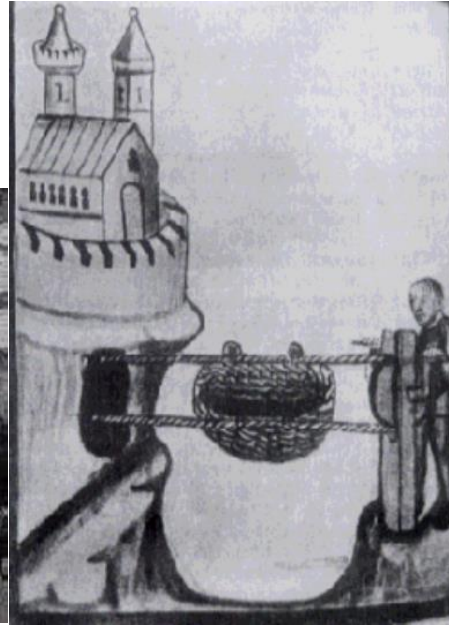

Introduction

- **From 1845** **Development of material transport systems for industry (mines, quarries, ...) and goods - Freiherr von Dücker, Cypher, Hodgson, Bleichert, Ceretti & Tanfani**

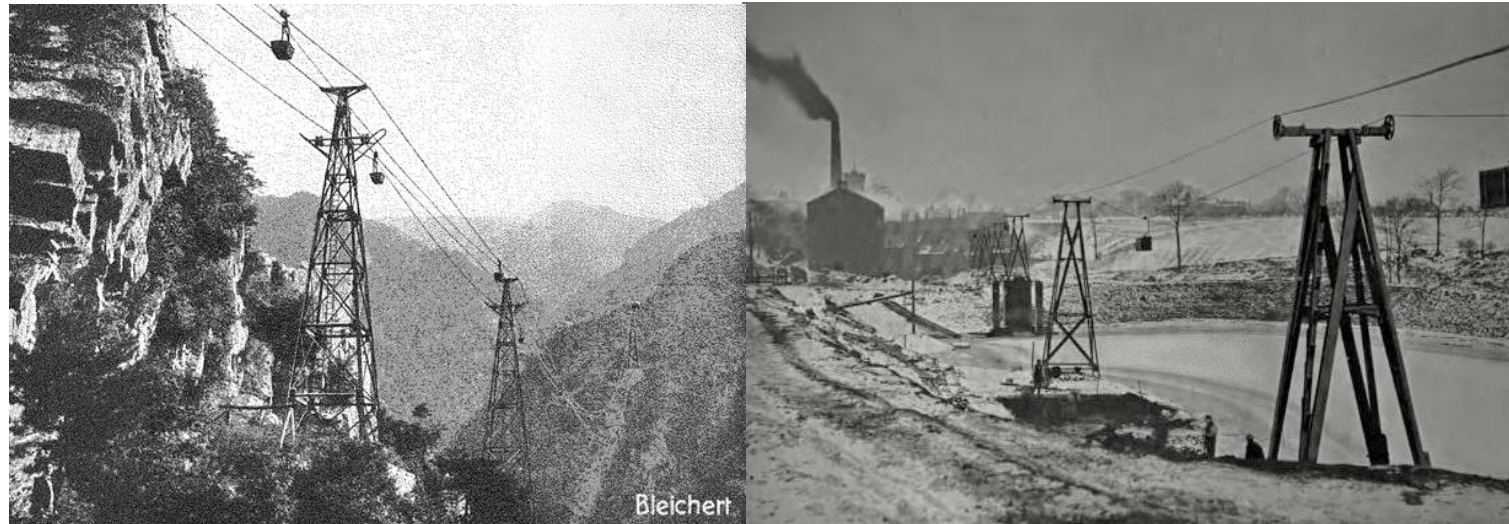

Introduction

- Ropes are transported to construction sites



Introduction

- **Development of transportation systems for military purposes**



Introduction

- **1845 The first funicular - Prospect Park Incline Railway, Niagara Falls (USA)**



Introduction

- **1862 The first funicular in Europe - Lyon (F)**

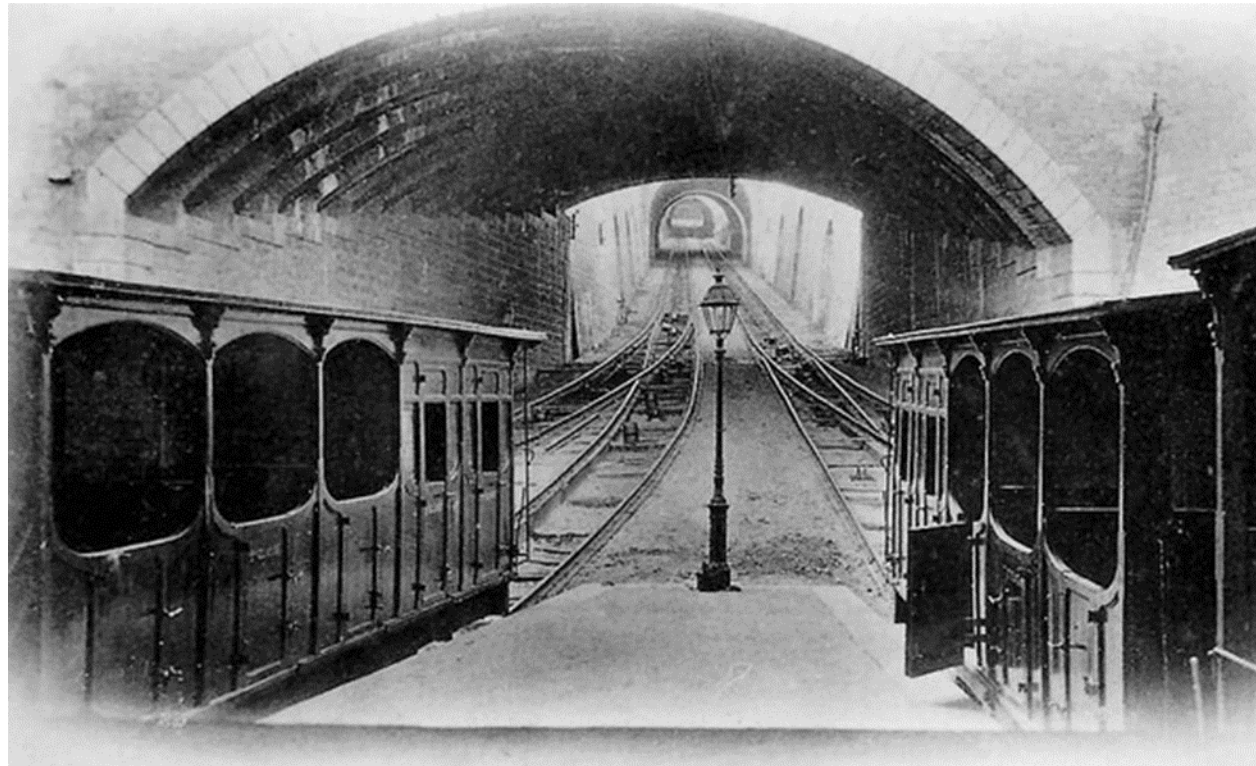

Introduction

- 1863 Invention of the rack



Introduction

- **1893 The first tourist cable car in the world, crossing the Tennessee River at Knoxville (USA) – Barney Joseph Gagnier**



Introduction

- **1901 The suspended funicular – Dresden (D)**

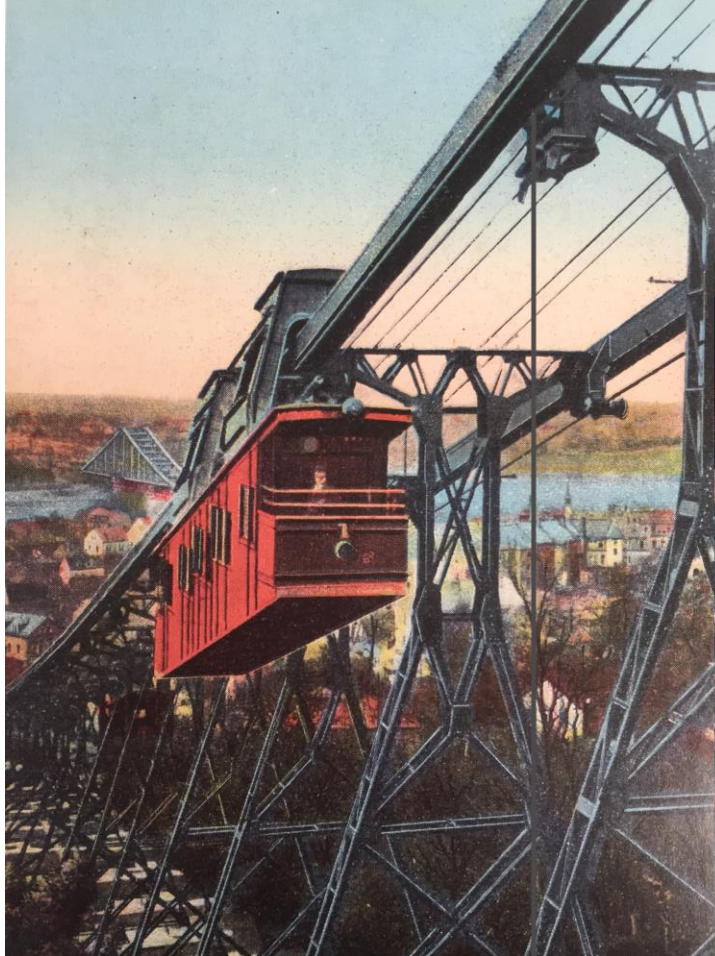

Introduction

- **1907 The ferry funicular - San Sebastian (E) - Leonardo Torres y Quevedo**

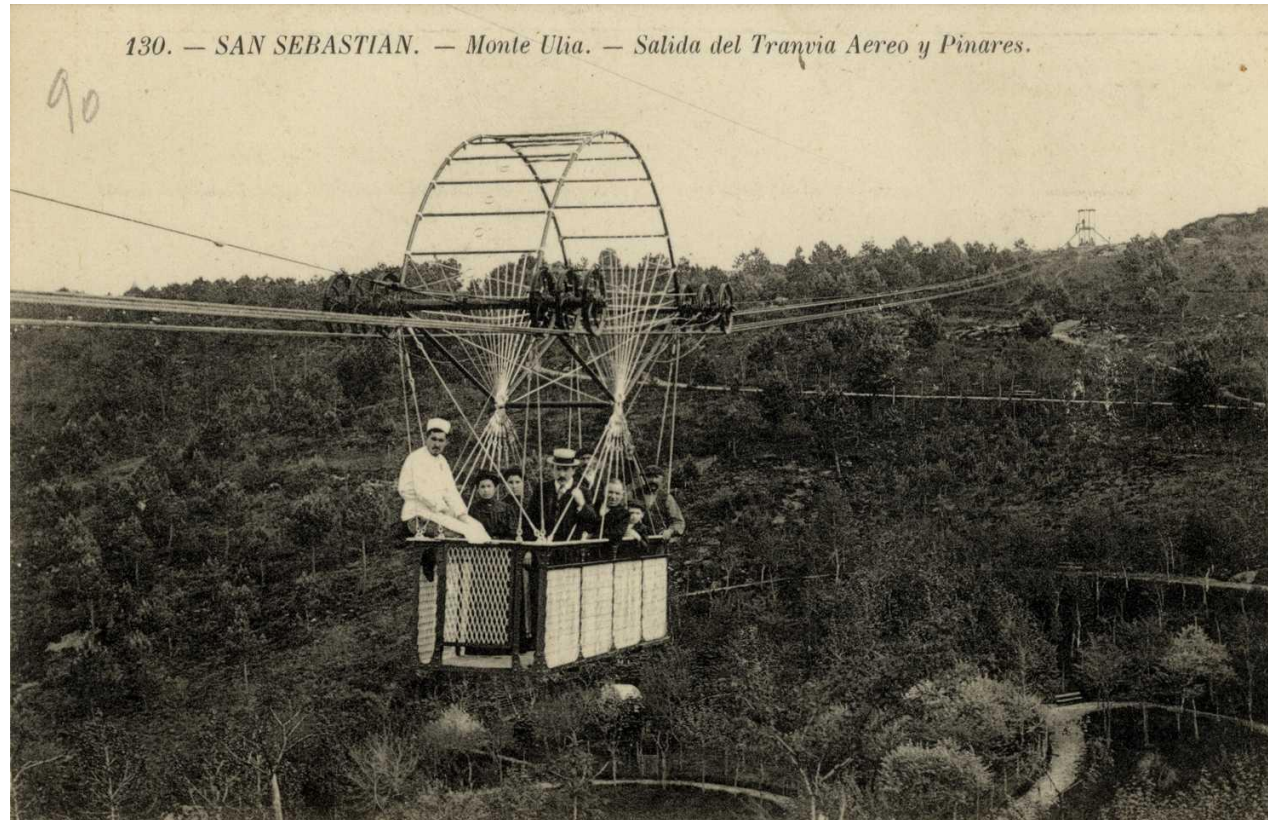

Introduction

- **1907 The first sled - Bödele, Vorarlberg (A)**



Introduction

- 1908 The rope elevator – Wilhelm Feldmann



Introduction

- **1908 The first reversible aerial ropeway – Kohlern, Bozen (IT)**



Introduction

- **1908 The first ski-tow – Schneckenhof, Schollach (D) - Robert Winterhalder**



Introduction

- **1936 The first chairlift - Sun Valley (USA) - Ing. James Curran**



Introduction

- **1945 The first detachable chairlift – Flims (CH) - Von Roll**



Introduction

- **1949 The first gondola – Belvedere, Alagna Valsesia (IT) - Ing. Carlevaro & Savio**



Introduction

- **1984 The first DMC - Serre Chevalier (F) - Ing. Denis Creissels & POMA**



Introduction

- **1990 The first Funitel - Val Thorens (F) - Ing. Denis Creissels & REEL**



Introduction

- **1990 The first 3S - Saas Fee (CH) – Von Roll**



Introduction

- Ropeways nowadays



Introduction

- Ropeways nowadays



Introduction

- Ropeways nowadays



Introduction

- Ropeways nowadays





ROMA 1957
PARIS 1963
LUZERN 1969
WIEN 1975

MÜNCHEN 1981
GRENOBLE 1987
BARCELONA 1993
SAN FRANCISCO 1999

INNSBRUCK 2005
RIO DE JANEIRO 2011
BOLZANO-BOZEN 2017



Introduction

What are the evolutionary factors linking the original ones to nowadays ropeways ?

- **performance increase (speed, capacity)**
- **comfort improvement**
- **increase in energy efficiency**
- **reduction of impacts (environmental, acoustic, visual)**
- **search for aesthetics**
- **product standardization and automation**



ROMA 1957
PARIS 1963
LUZERN 1969
WIEN 1975

MÜNCHEN 1981
GRENOBLE 1987
BARCELONA 1993
SAN FRANCISCO 1999

INNSBRUCK 2005
RIO DE JANEIRO 2011
BOLZANO-BOZEN 2017



Introduction

Throughout the evolutionary history of the ropeways the common thread is the search for

SAFETY

- **what has been the improvement of safety in the evolution of cableways?**
- **what we currently do and what is the level of security achieved today?**

Introduction



Bibliography:

- **l'Aiguille du Midi et l'invention du téléphérique – Pierre-Louis Roy**
- **www.remontées-mécaniques.net**
- **www.seilbahn-nostalgie.ch**
- **Mr. Istvan Szalai - Garaventa AG**



ROMA 1957
PARIS 1963
LUZERN 1969
WIEN 1975

MÜNCHEN 1981
GRENOBLE 1987
BARCELONA 1993
SAN FRANCISCO 1999

INNSBRUCK 2005
RIO DE JANEIRO 2011
BOLZANO-BOZEN 2017



Evolution



ROMA 1957
PARIS 1963
LUZERN 1969
WIEN 1975

MÜNCHEN 1981
GRENOBLE 1987
BARCELONA 1993
SAN FRANCISCO 1999

INNSBRUCK 2005
RIO DE JANEIRO 2011
BOLZANO-BOZEN 2017



Evolution technologique / *Technological evolution*

by **J. Sutter** - O. Bertolami

Evolution technologique / *Technological evolution*

- Chair lift



1937

Doppelmayr manufactures its first ski lift for the practice slope in Zürs am Arlberg (Austria).



1976

Doppelmayr builds its first detachable 2-seater chairlift on the Großvenediger in Neukirchen (AUT).



1998

world novelty:
first detachable 8-seater chairlift

Evolution technologique / *Technological evolution*

- Chair lift



2008

is approved for carrying seven children with a minimum body height of 90 cm accompanied by just one adult.



2009

The chair model CS10



2015

Doppelmayr develops the next ropeway generation D-Line. The D-Line sets new standards in terms of safety, comfort and design.

Evolution technologique / *Technological evolution*

- Gondola lift



1972

Doppelmayr builds the first detachable gondola lift in Mellau (AUT). It marks the beginning of the successful implementation of this ropeway technology.



1986

World's first 8-MGD in Steamboat Ski Resort, USA

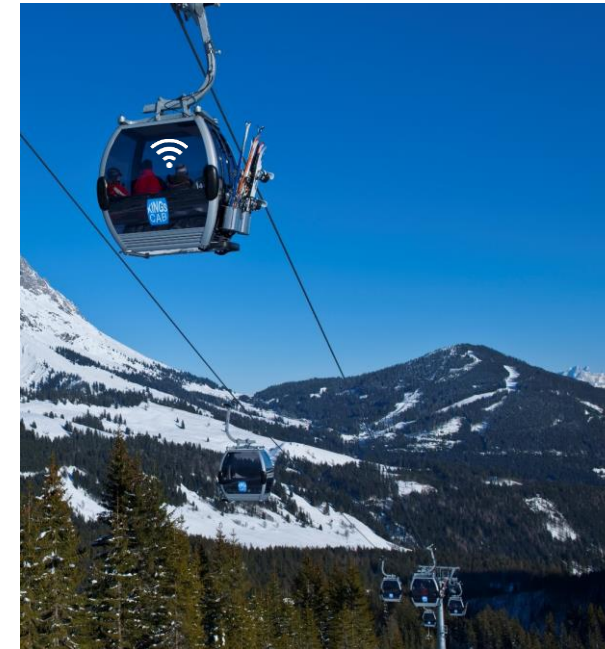

2008

The first time in the world a MGD ropeway is equipped with WI-FI, Hochkönig, AUT

Evolution technologique / Technological evolution

- Gondola lift



2011

first evacuation concept for continuous monocable ropeways



2015

Doppelmayr develops the next ropeway generation D-Line. The D-Line sets new standards in terms of safety, comfort and design.



2020

Doppelmayr presents the world's first gondola lift with AURO ("Autonomous Ropeway Operation") in Zermatt, CHE. AURO is pioneering the future of cable-pulled mobility.

Evolution technologique / Technological evolution

- Further milestones in ropeway history



1995
Doppelmayr's first Funitel in Hintertux (AT)



2002
L'Olympique in Val d'Isère is the first tri-cable gondola lift built by Doppelmayr.



2004
Doppelmayr builds the first Funifor gondola in Alagna (IT).

Evolution technologique / Technological evolution

- Further milestones in ropeway history



6/10-CGD Sunrise Express
First D-Line combination lift



120 ATW-Zugspitze
Highest steel lattice tower (127 m), largest vertical rise (1,945 m) and longest rope span (3.213 m) of a ropeway worldwide

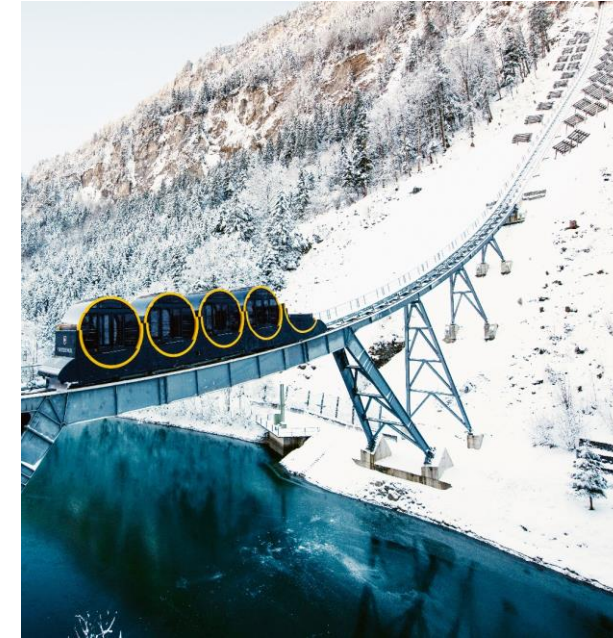

136-FUL Schwyz-Stoos
Steepest funicular ropeway in Europe (48°)

Evolution technologique / *Technological evolution*

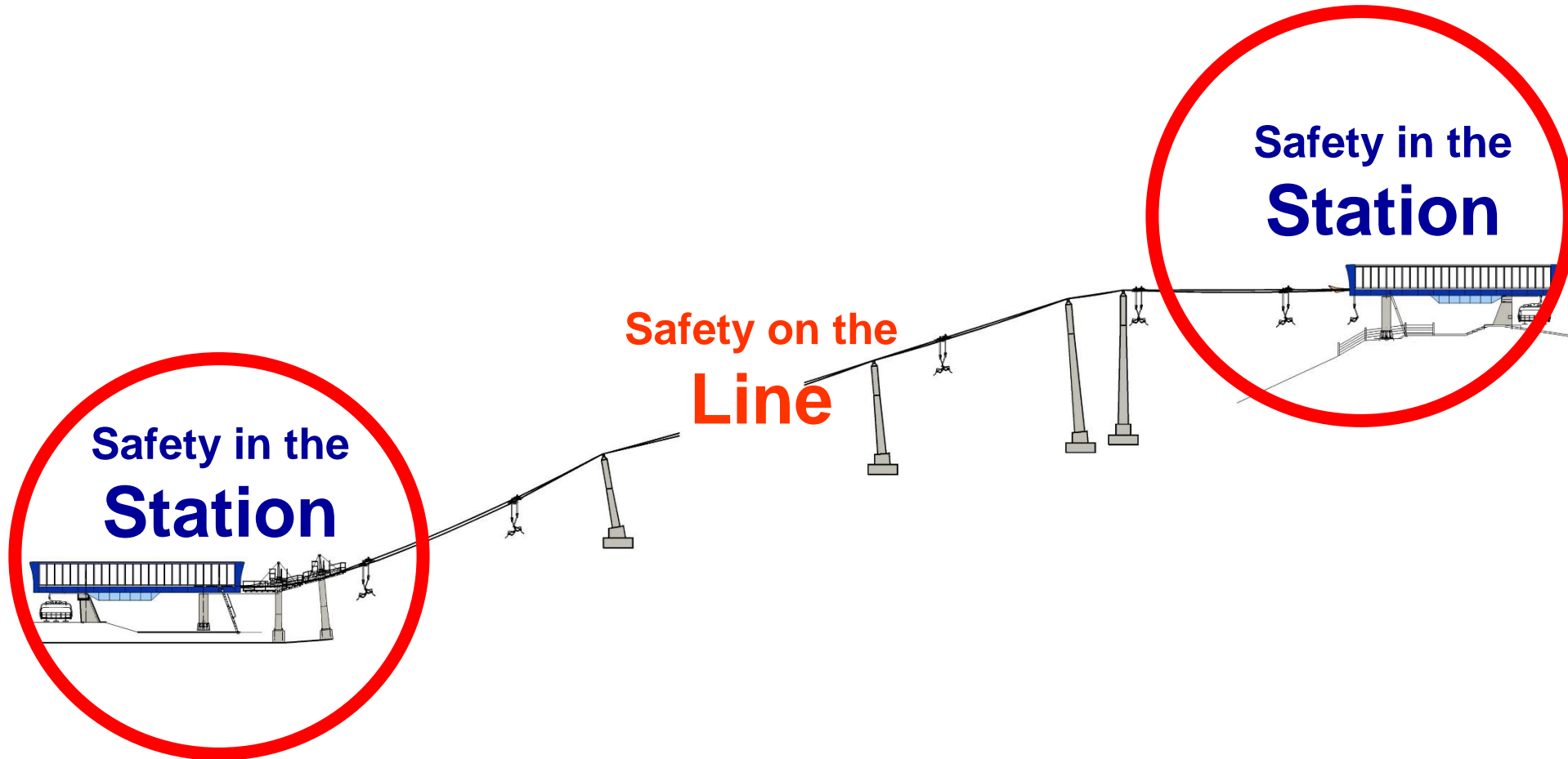

Evolution technologique / *Technological evolution*

- Stations – before CEN

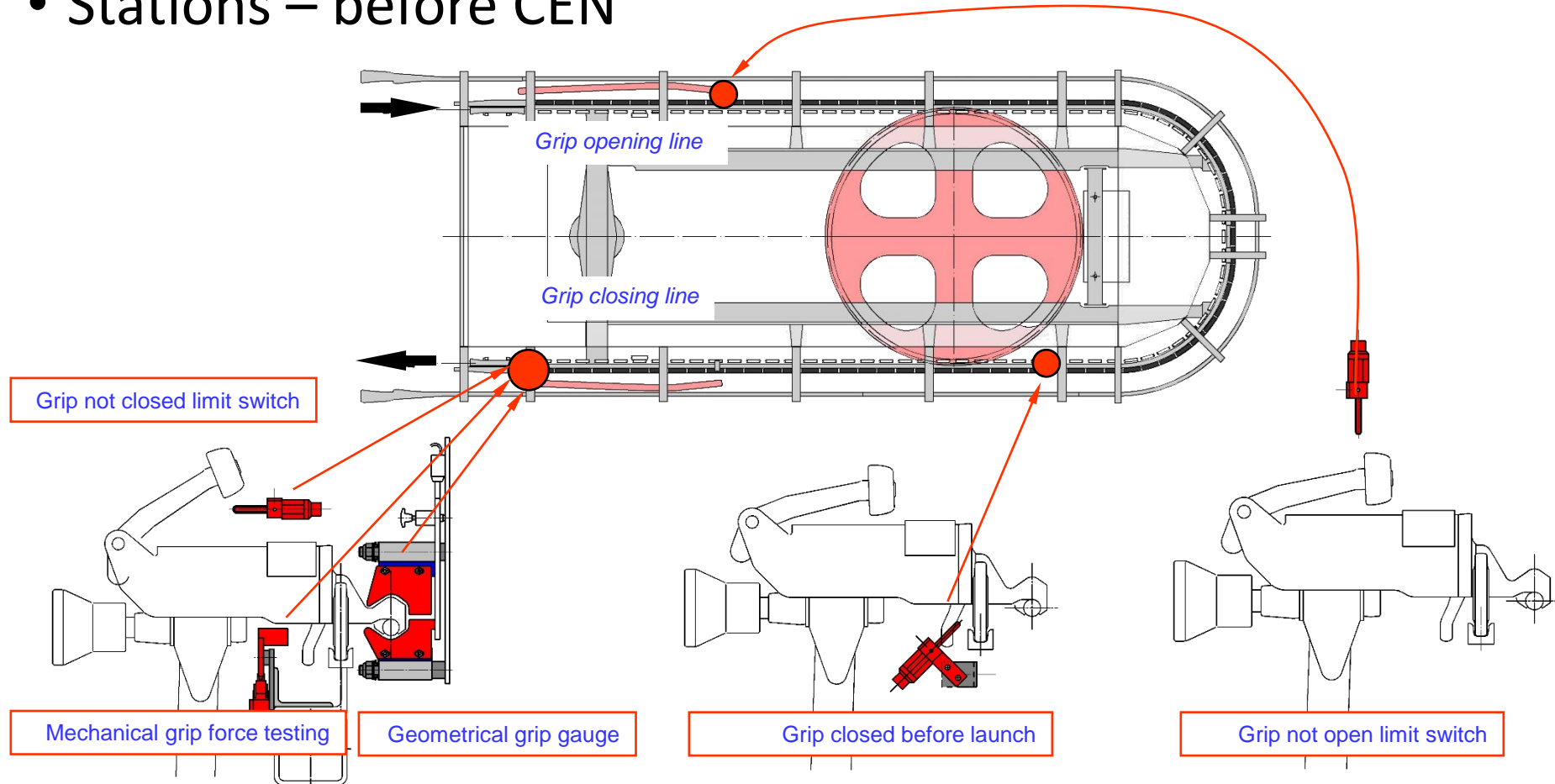

Evolution technologique / *Technological evolution*

- Stations

- Cross Reference: EN 13796-1:2017 (E) (“Carriers, Grips, etc.”)

7.5.3.8 *The following requirements shall be met:*

... geometrical positions of the rope and the gripping jaws shall be monitored ...

... the position of the gripping jaw on the rope in the closed position shall be checked ...

... detachment of the grips shall be monitored ...

Evolution technologique / Technological evolution

• Stations – CEN (D-LINE)

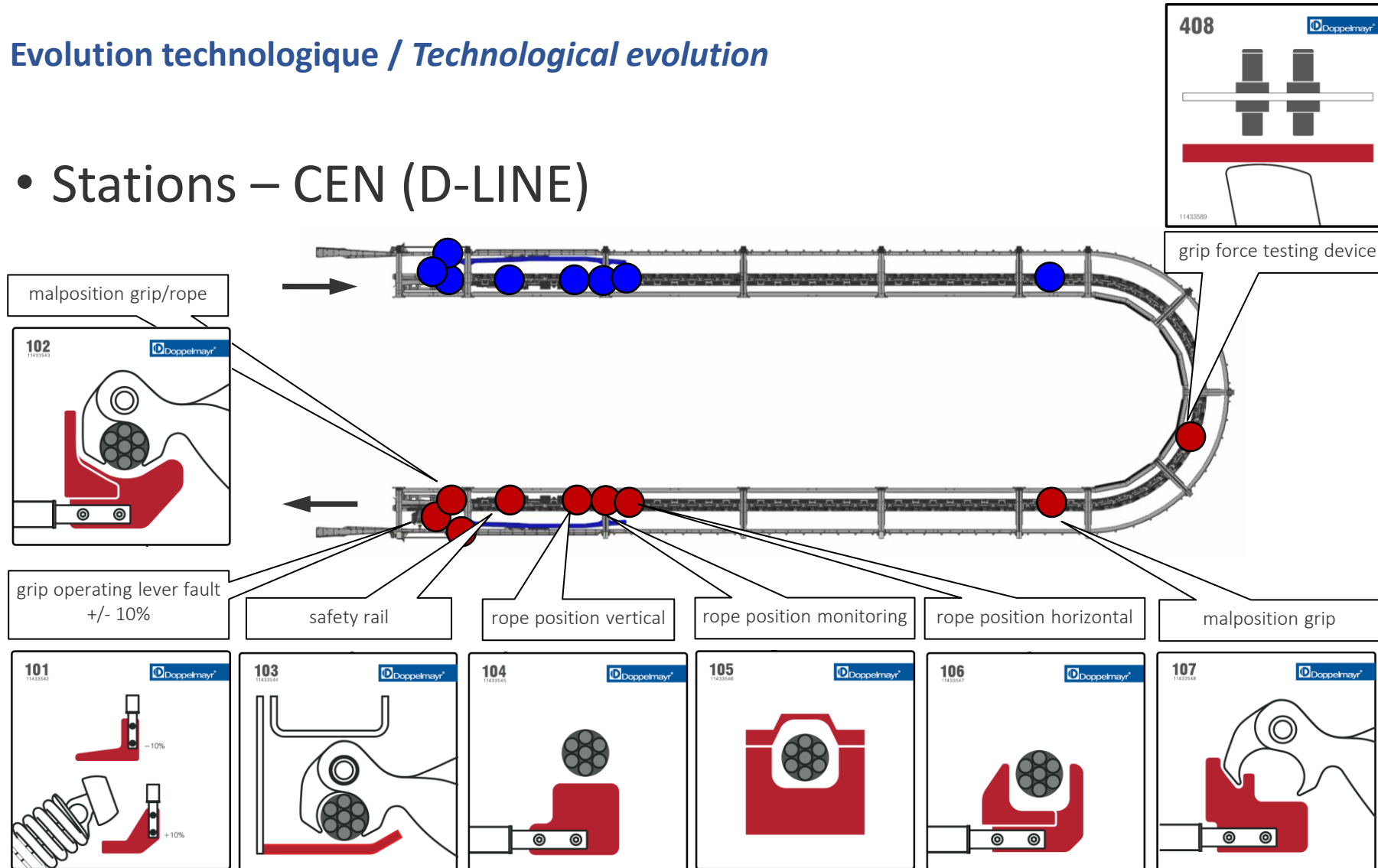

Evolution technologique / Technological evolution

- Gondola



Entrance situation 1995



Entrance situation 2003



Entrance situation 2014

Evolution technologique / *Technological evolution*

- Funicular Railway



Elementary Entrance Situation

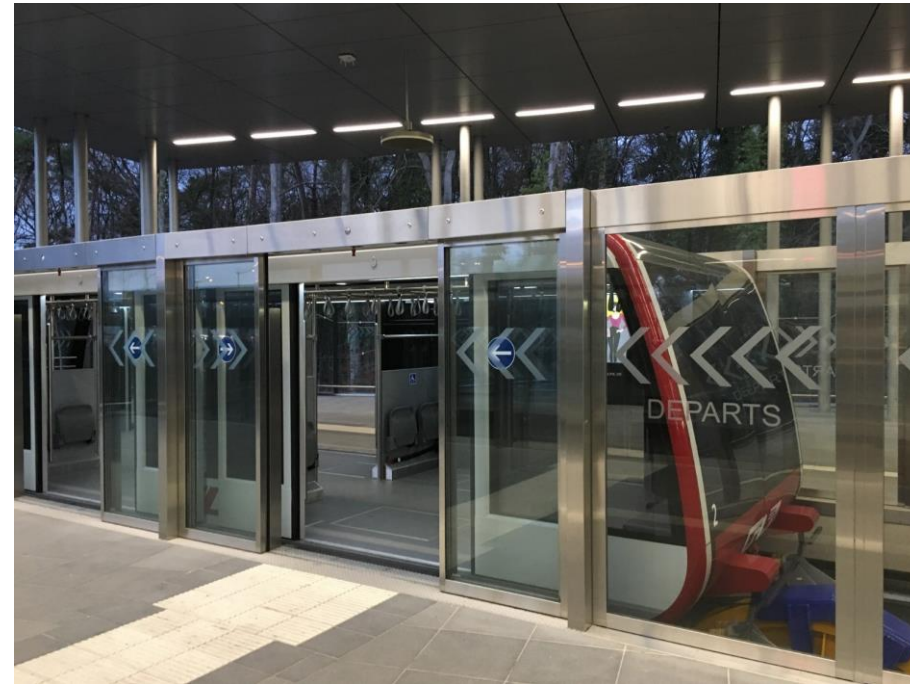

State of the Art Entrance

Evolution technologique / *Technological evolution*

- Reversible aerial tramway



Entrance situation 1980s



Entrance situation 1990s

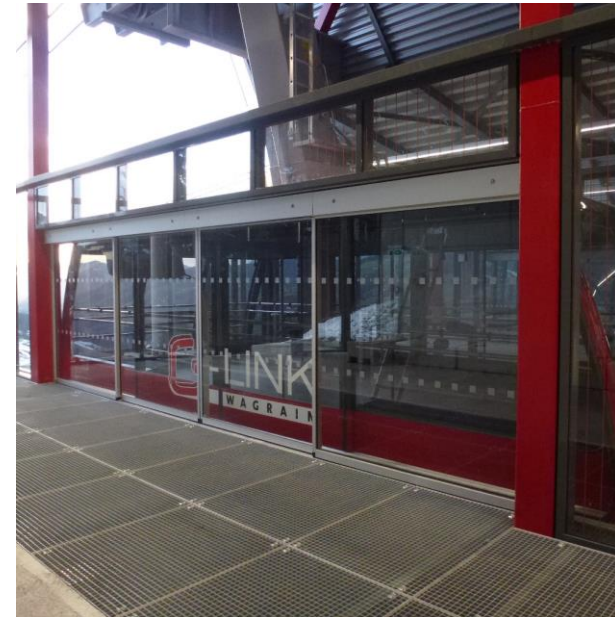

Entrance situation 2010s

Evolution technologique / *Technological evolution*

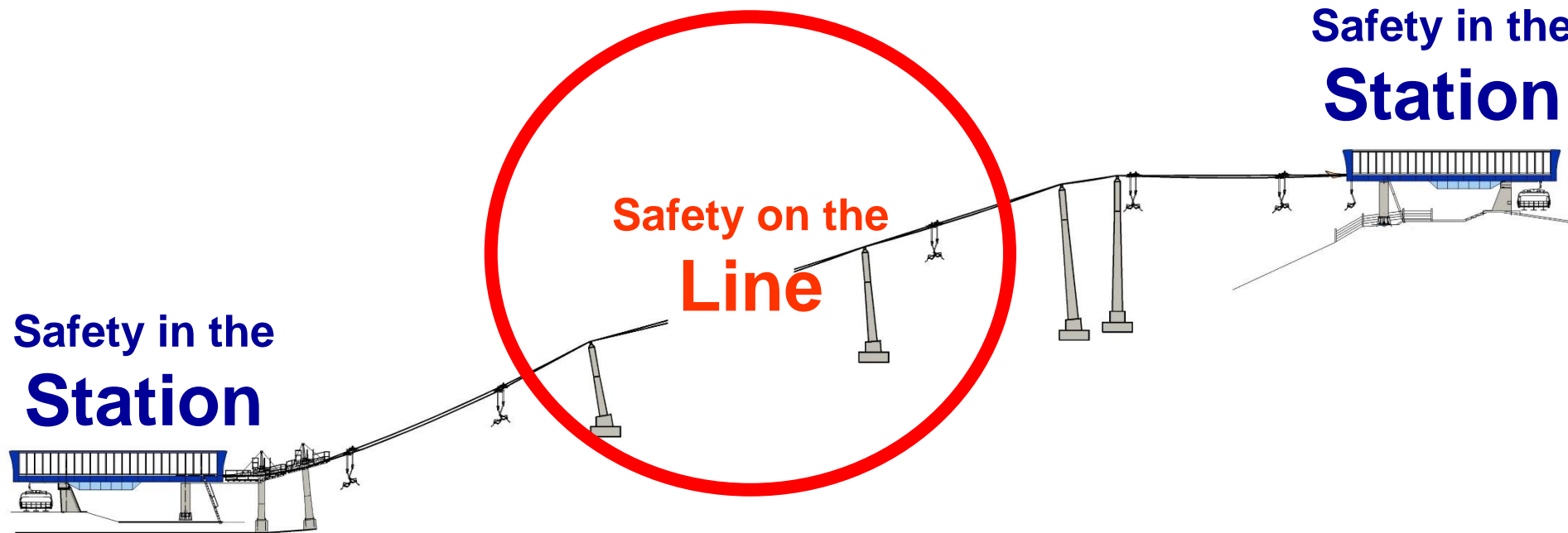

Evolution technologique / *Technological evolution*

- Sheave Assemblies



Roller of an early generation

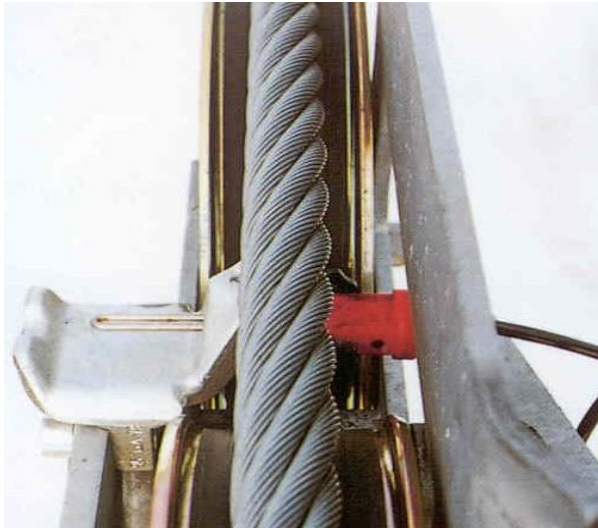

Break fork switch in rope catcher

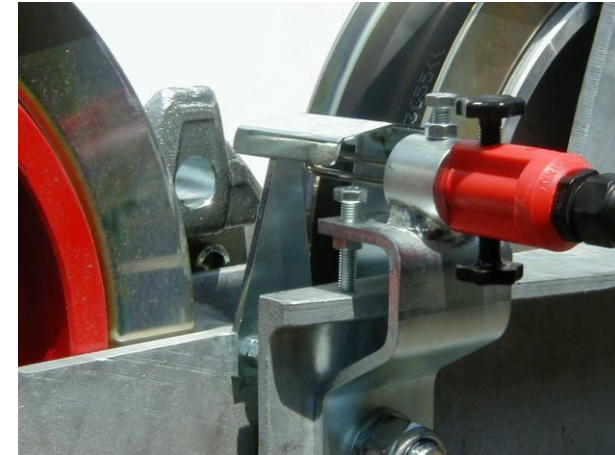

Break fork switch with drop weights at incoming and outgoing rockers

Evolution technologique / Technological evolution

- Sheave Assemblies



RPD – Rope Position Detection
since 1997

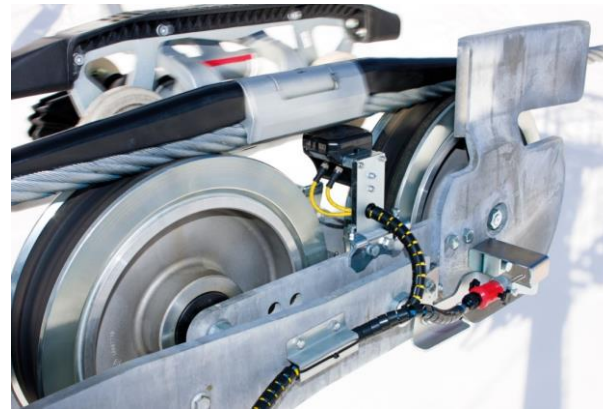

Break fork switch with drop weights on every
2-roller; CEN conform; since 2004



RPD Nexo
Latest safety equipment; since 2017

Evolution technologique / Technological evolution

- Sheave Assemblies

- Cross Reference: EN 13223:2015 (E) (“Drive systems and other mechanical equipment ”)

18.1.3.5

The freedom of movement of the battery rockers shall be limited to ensure passage of the grips:

- *if a roller becomes seized, provided it is not monitored by a safety function;*
- *if a roller is missing;*
- *if the rope is wholly or partly derailed from the rollers onto the rope-catchers*

18.1.8.3

...switches on... the lead-on side of the roller batteries

...in the case of more than four rollers, also on the lead-off side.

...switches...triggered immediately by a deropement...

Evolution technologique / Technological evolution

- Sheave Assemblies – CEN conform

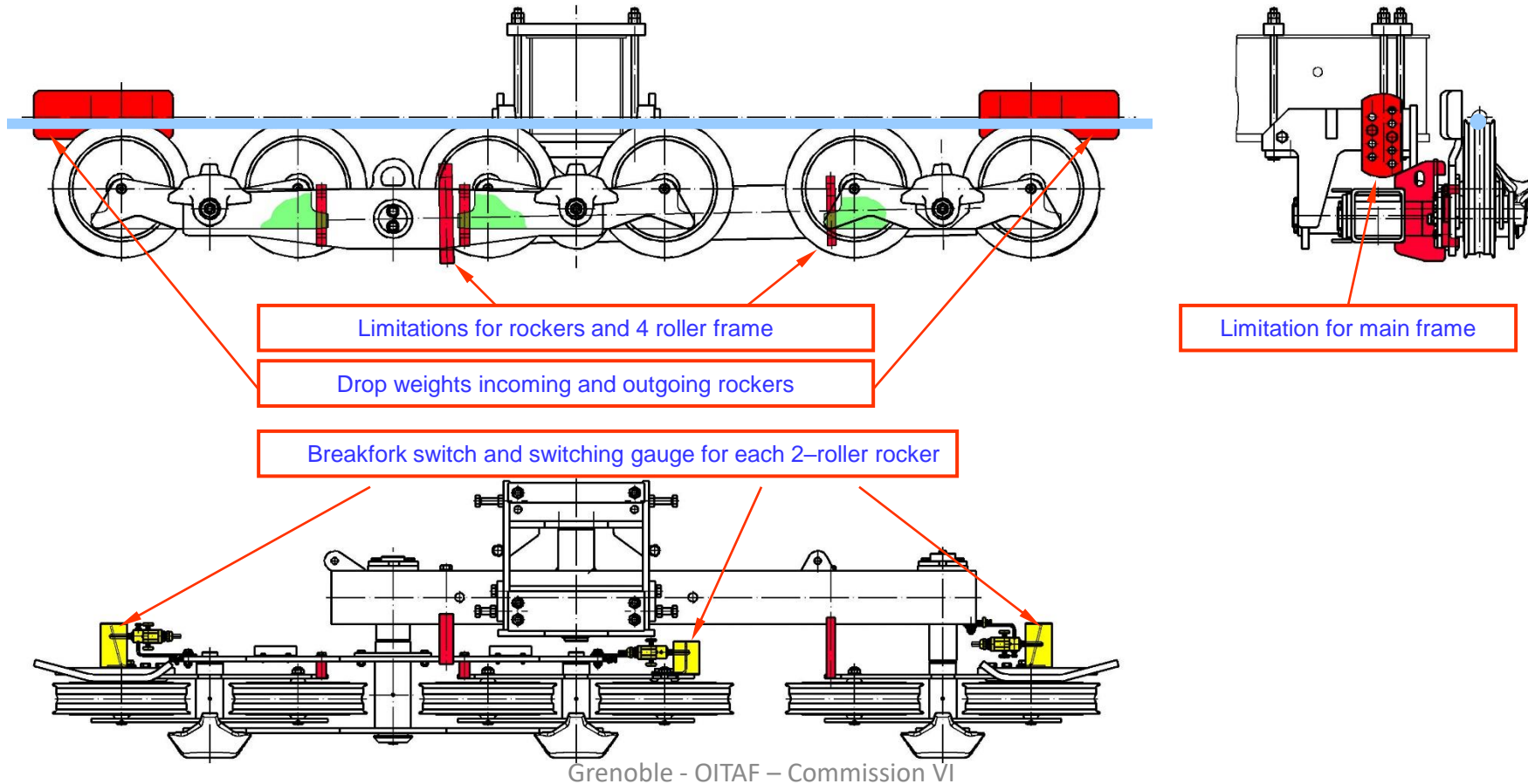

Evolution technologique / Technological evolution

- Sheave Assemblies – CEN conform testing

Cross Reference EN: 7.7.2.14 *The grips and rope catchers shall be designed so as to allow passage of the grip clamped on the rope in the rope catcher. Compliance with this requirement shall be demonstrated by testing under conditions similar to those in operation.*

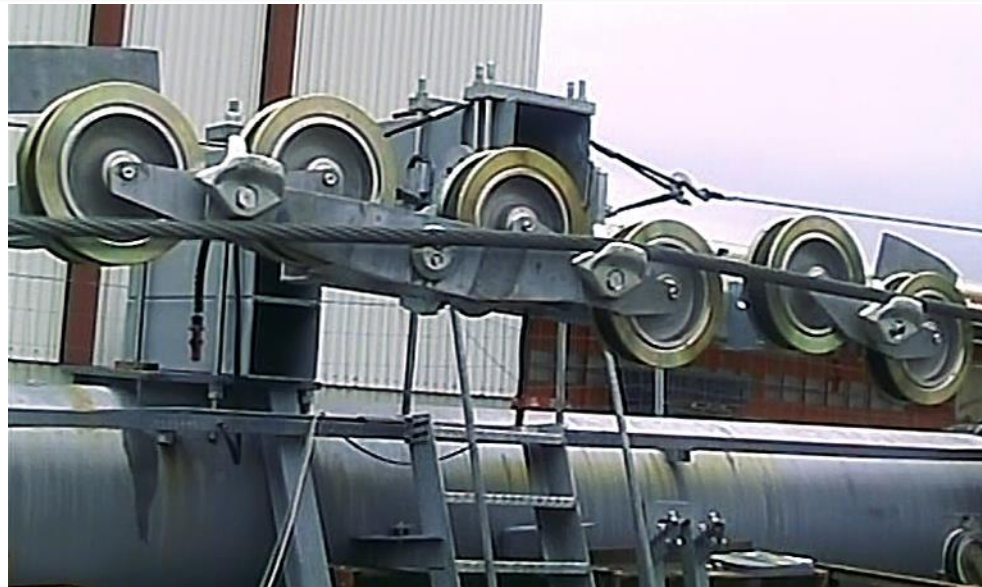

Evolution technologique / *Technological evolution*

- Sheave Assemblies
 - Increased derailment resistance

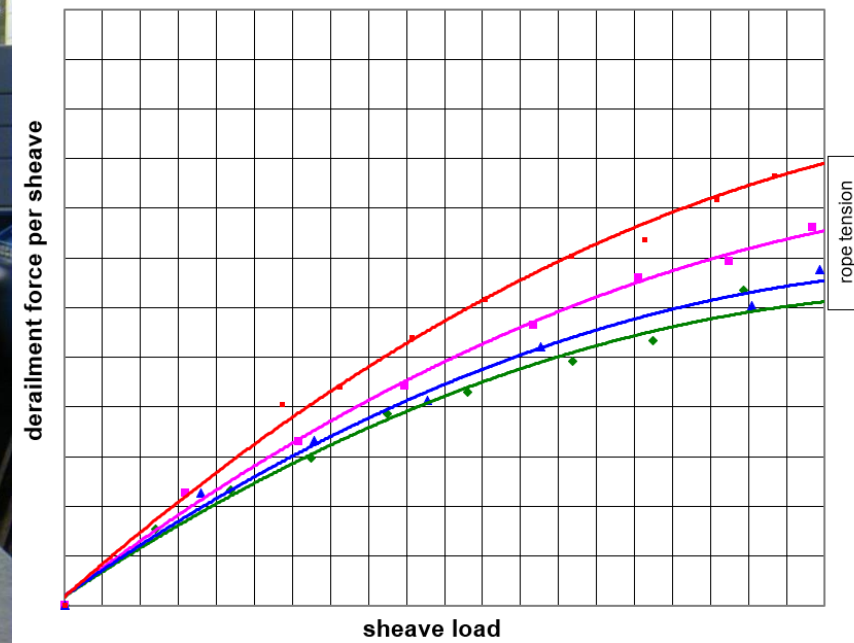

Evolution technologique / *Technological evolution*

- Towers
 - Tower and line observation



Evolution technologique / *Technological evolution*

- Chairs



Chair without restraining bar



Traverse restraining bar

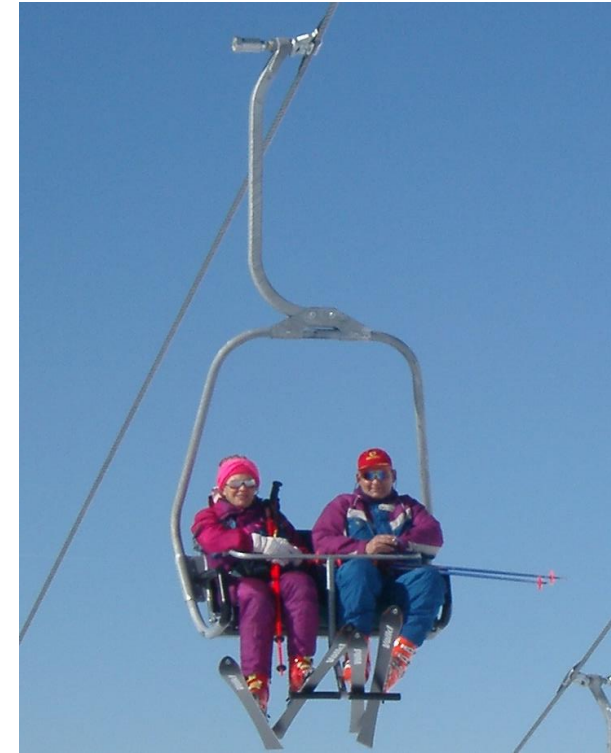

Overhead restraining bar

Evolution technologique / *Technological evolution*

- Chairs



Lockable restraining bar



Auto closing and lockable restraining bar

Evolution technologique / Technological evolution

- Chairs

- Cross Reference: EN 13796-1:2017 (E)

11.4.3 Safety bars and footrests

11.4.3.1 *The safety bars shall be designed so that they close from above the passengers' heads. They generally include footrests. For children, the closing handle shall be located at a height of no greater than 0,85 m above the seat (see Figure 9).*

11.4.3.3 *The safety bars shall be designed so as not to cause any injuries (trapping, shearing) to the passengers during use under the conditions set forth in EN 12397.*

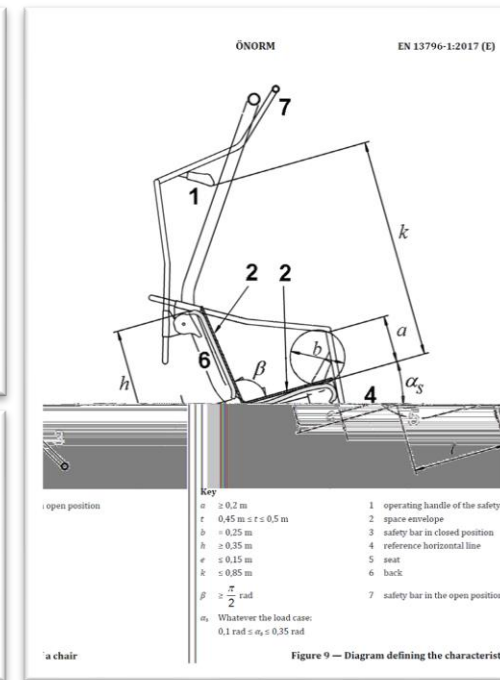

Evolution technologique / *Technological evolution*

- Chairs



8-seat chair with additional child safety equipment Skippy

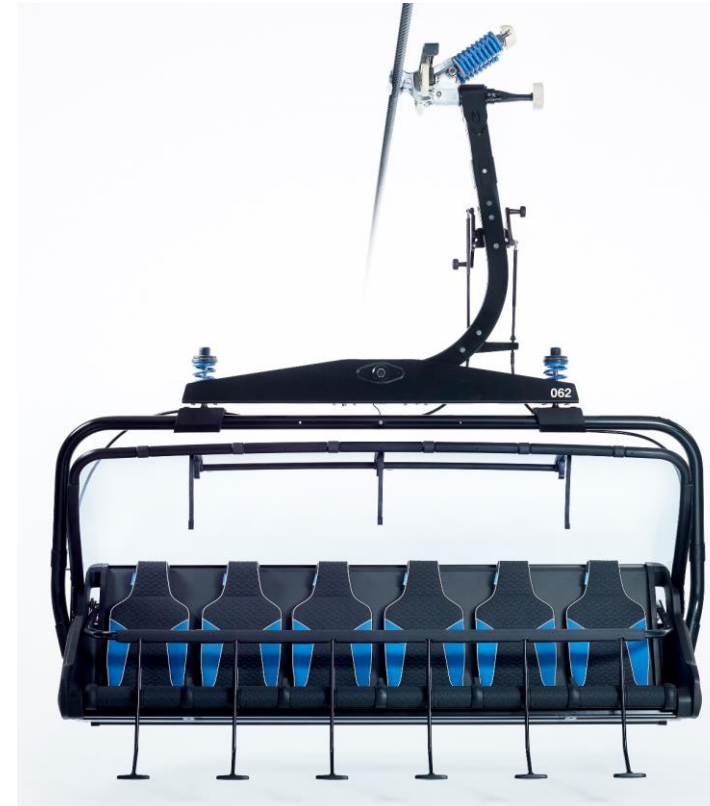

D-Line chair with auto-close, -lock, -open restraining bar and individual footrest

Evolution technologique / *Technological evolution*

- Chairs

- Skippy+ (enhanced protection for chairs without individual footrests)

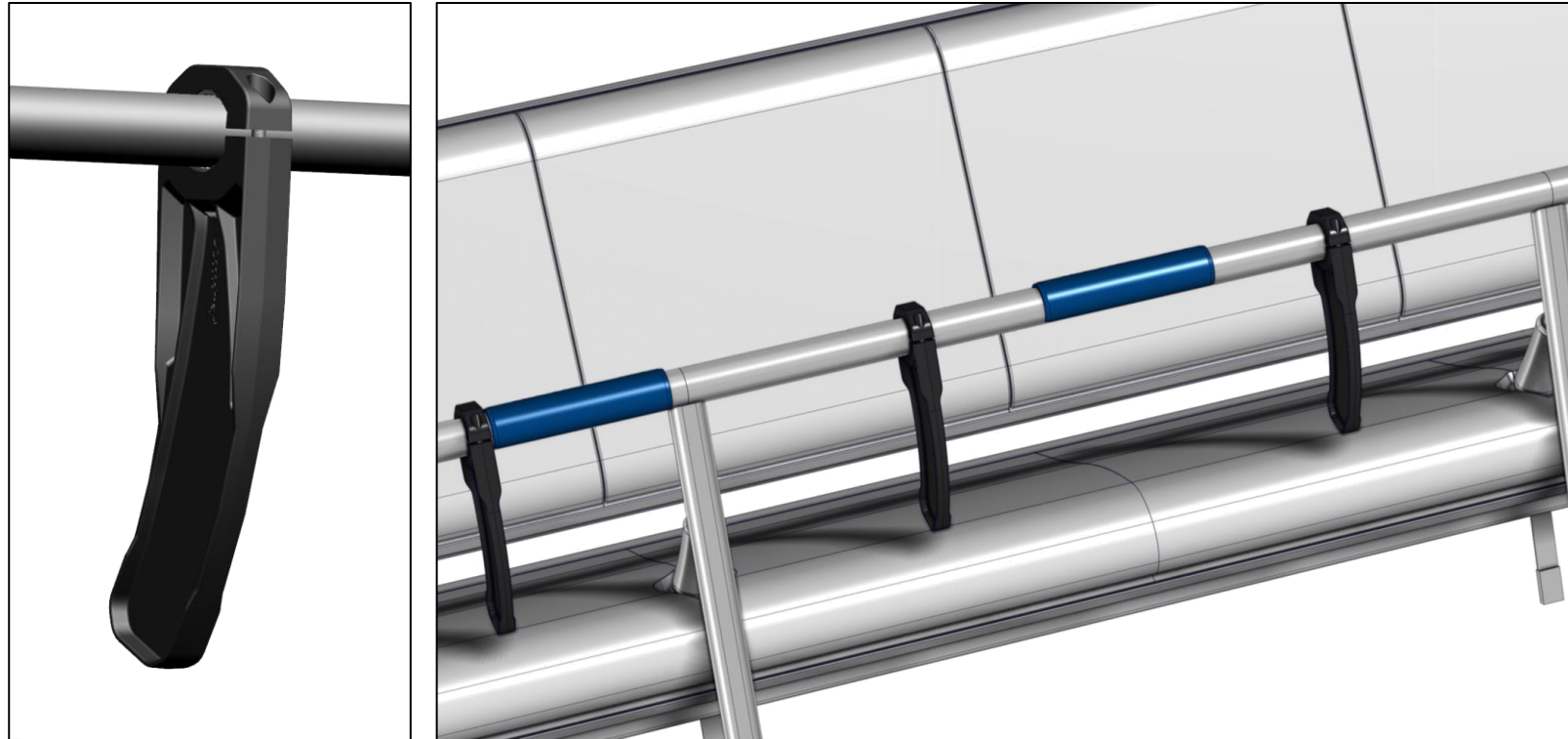

Evolution technologique / *Technological evolution*

- Chairs
 - Seat-and backrest-heating

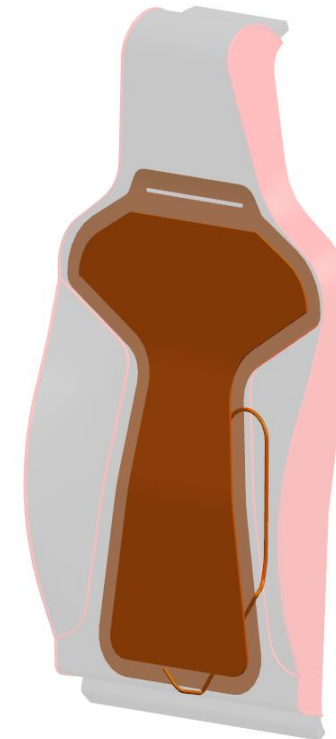

Evolution technologique / *Technological evolution*

- Chairs
 - oscillation-damper

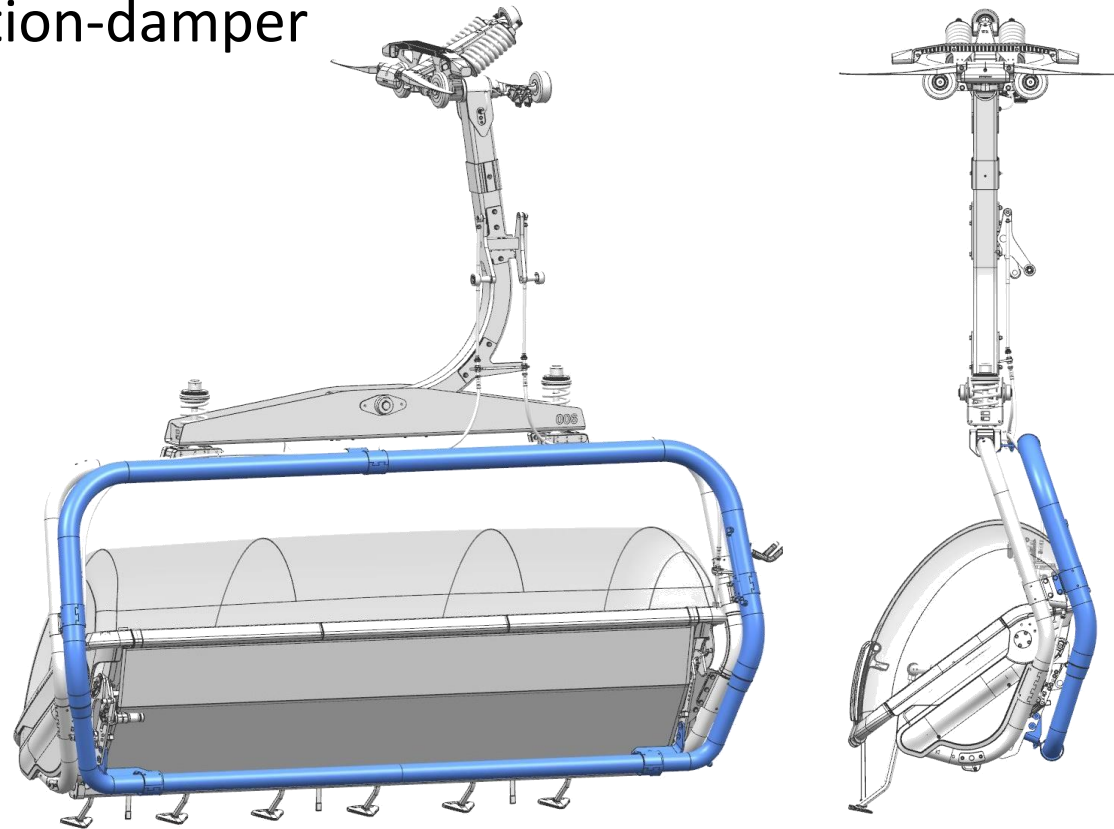

Evolution technologique / *Technological evolution*

- Chairs
 - oscillation-damper



With active damper

Without damper

Evolution technologique / Technological evolution

- Gondola
 - Passenger communication

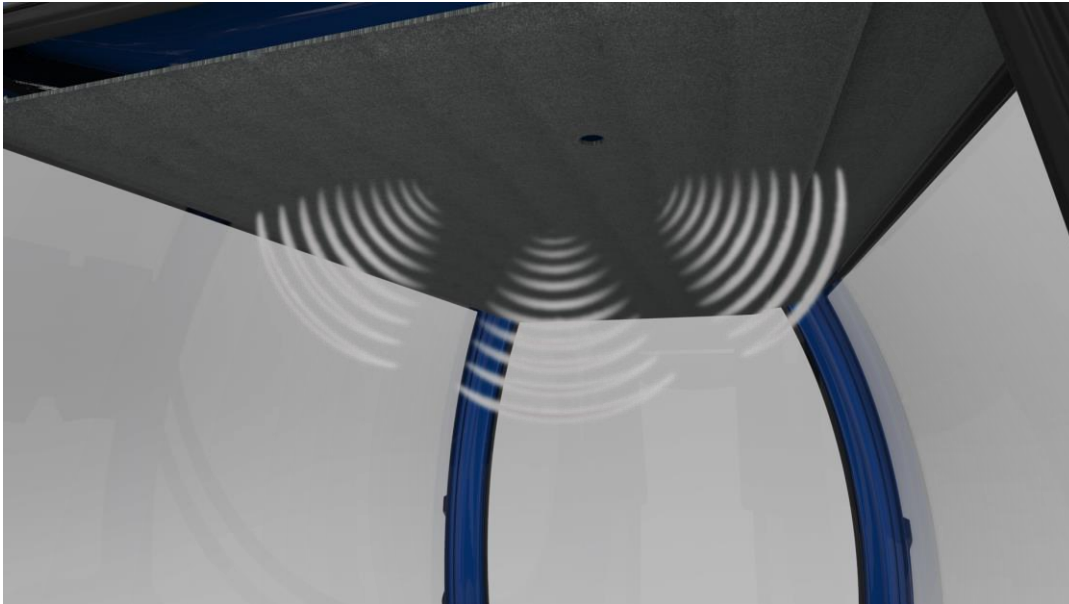

Wireless public address system



Wireless intercom system

Evolution technologique / Technological evolution

- Funicular Railway



Automatic fire detection and extinguishing systems

Cross Reference CEN/TR 14819-1:2004 (E): 6.14. Extinguishers and other means of firefighting (in carriers)
In the absence of any national standards, it is recommended that at least one portable extinguisher should be installed in each passenger compartment...

Evolution technologique / *Technological evolution*

- Primary Passengers in the mountains...



Rescue
concepts



Evolution technologique / Technological evolution

- Urban- and POI- ropeways bring new passengers...



Rescue
concepts



Evolution technologique / Technological evolution

- RECOVERY SYSTEM

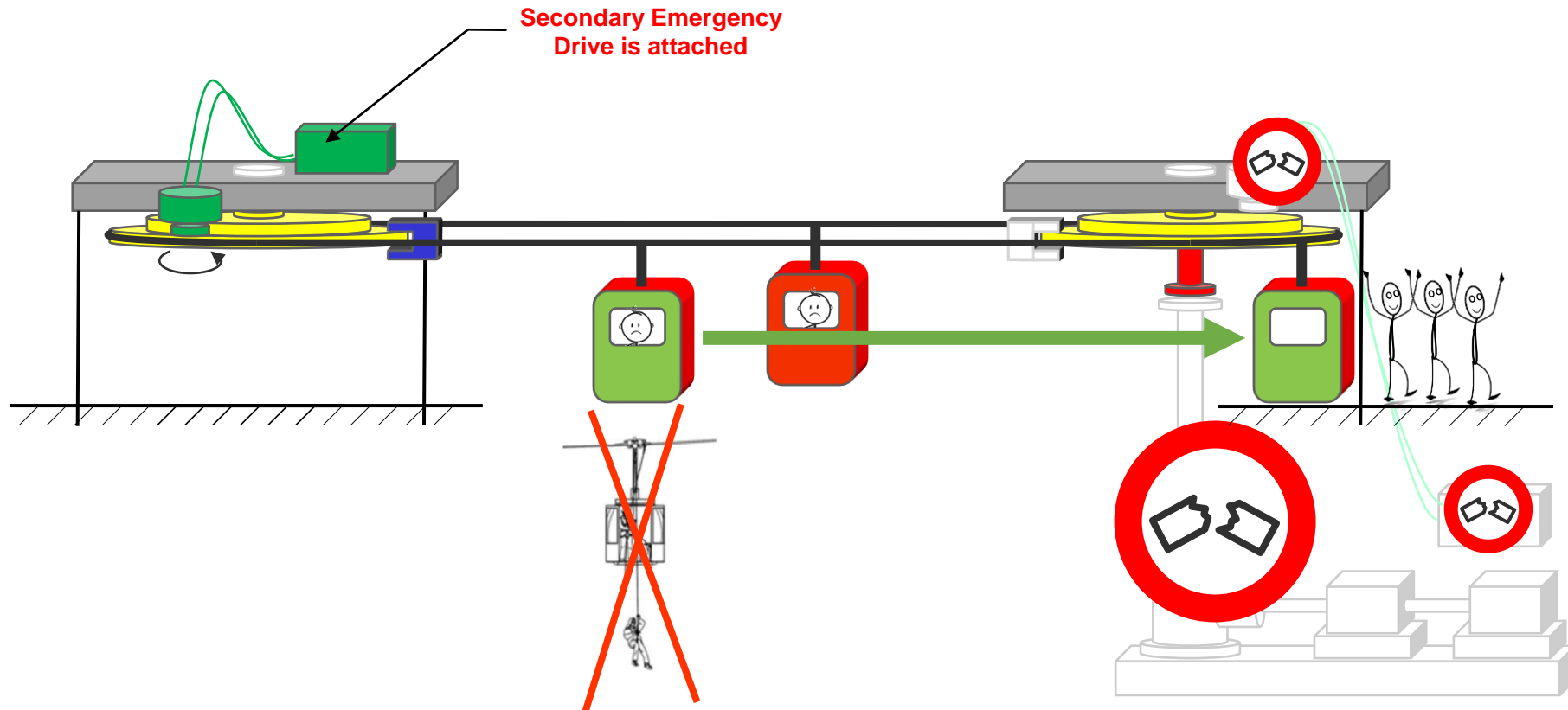



ROMA 1957
PARIS 1963
LUZERN 1969
WIEN 1975

MÜNCHEN 1981
GRENOBLE 1987
BARCELONA 1993
SAN FRANCISCO 1999

INNSBRUCK 2005
RIO DE JANEIRO 2011
BOLZANO-BOZEN 2017



Evolution technologique / *Technological evolution*

by J. Sutter - **O. Bertolami**

From design to opening to public

Design

Safety Analysis
Calculation
Tests
CE Certification



Manufacturing

Automatisation
Quality Control

Construction

Quality Control
Tests



Design : Systematic Safety Analysis

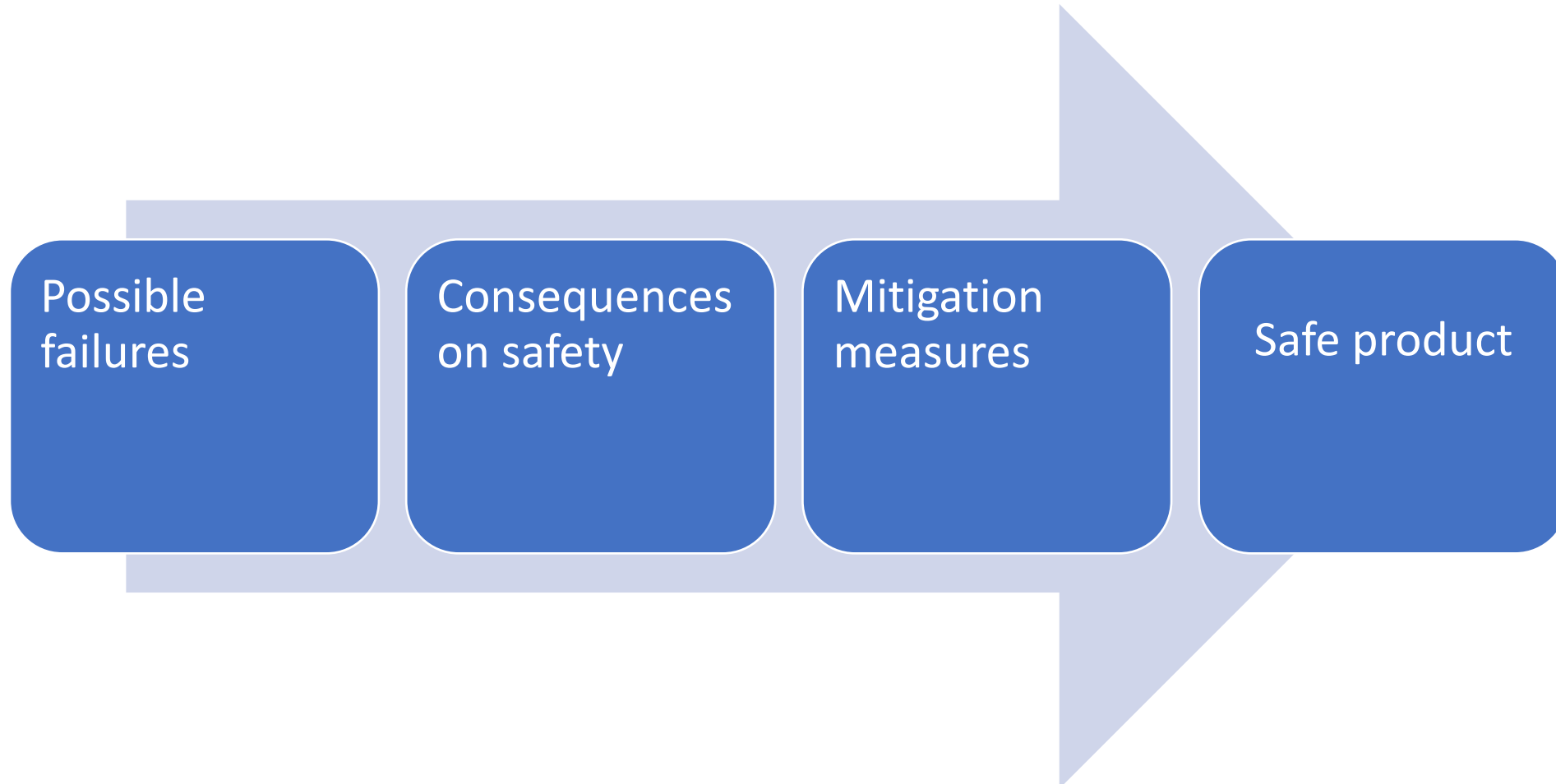

DESIGN - Safety improvement

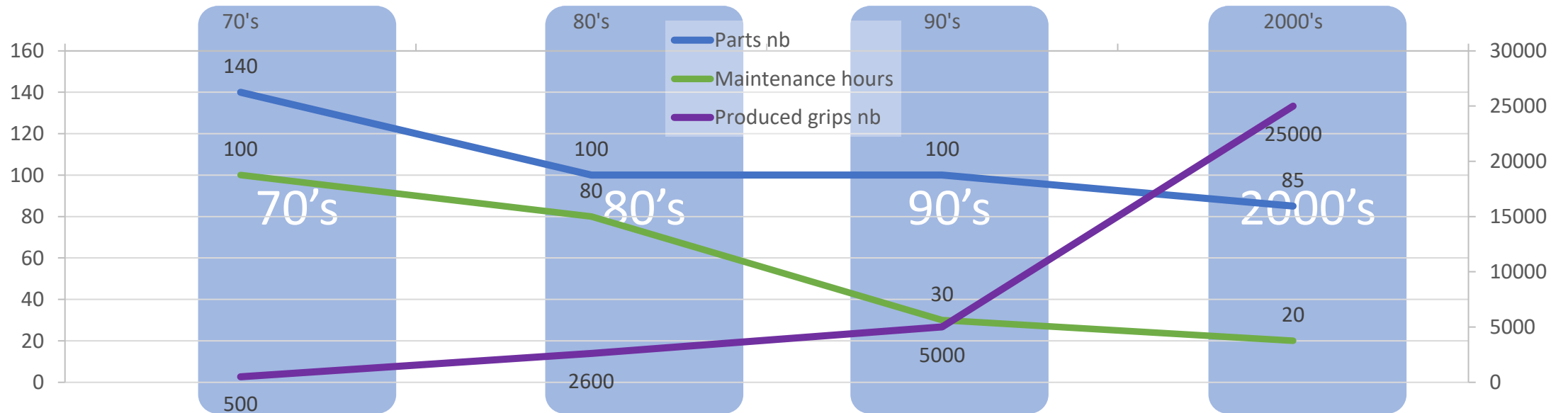
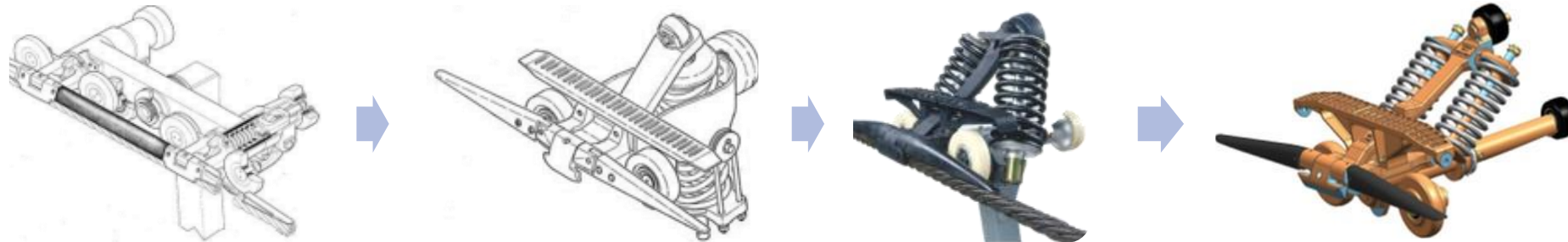

Design : Calculation

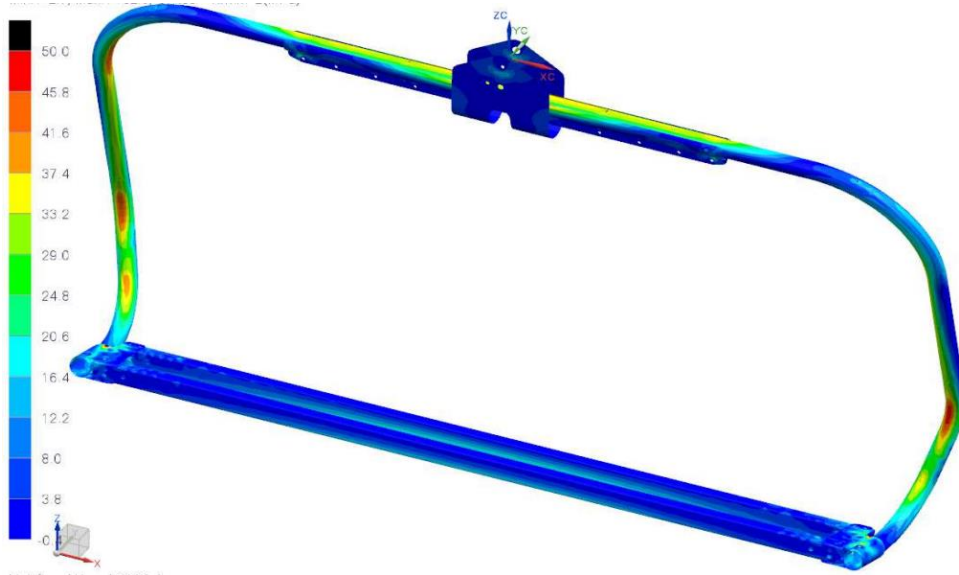

FEA

Design Optimization

Weight saving

Fatigue stress

Line Calculation

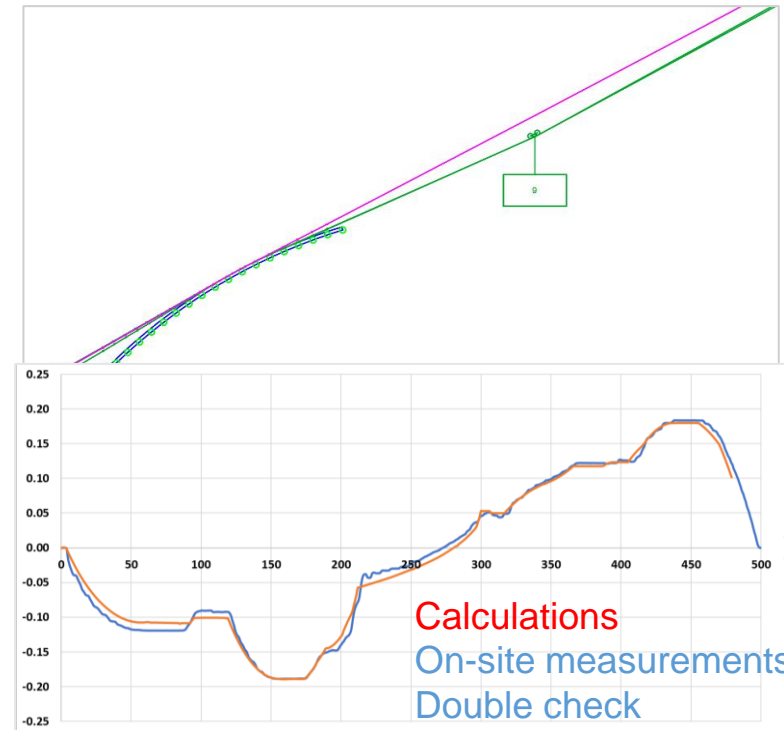

All worse situations are virtually verified
More phenomenon are taken into account

Design : Qualification tests

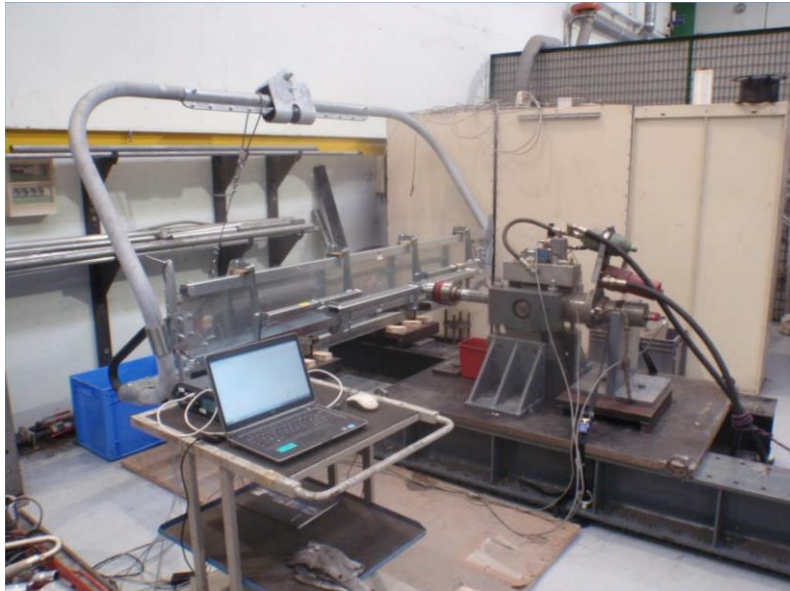

Design and calculation validation on physical test benches : Worse case scenarii tested

Design : Certification

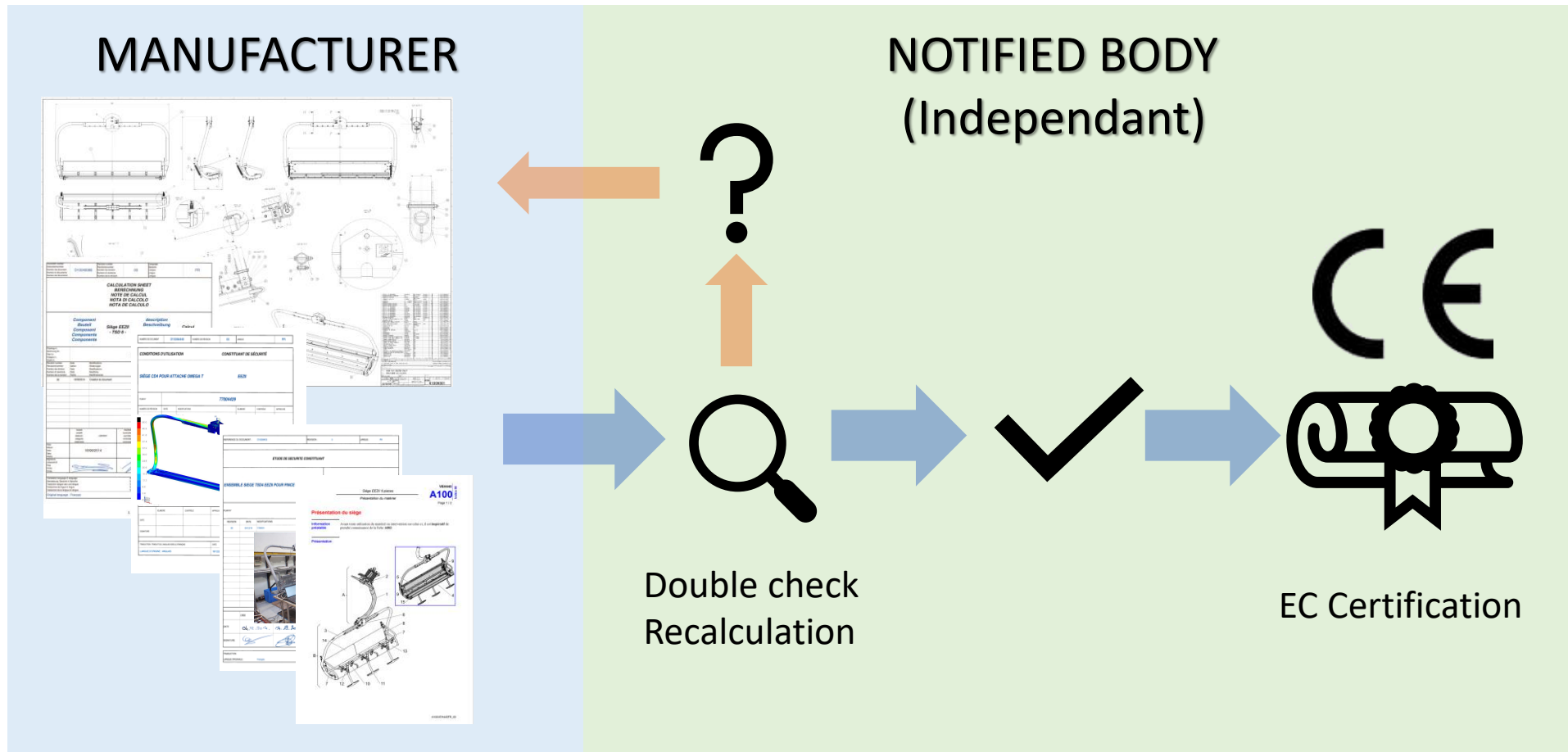

Manufacturing : Automatisation + Pre assembling



Manufacturing : Quality control

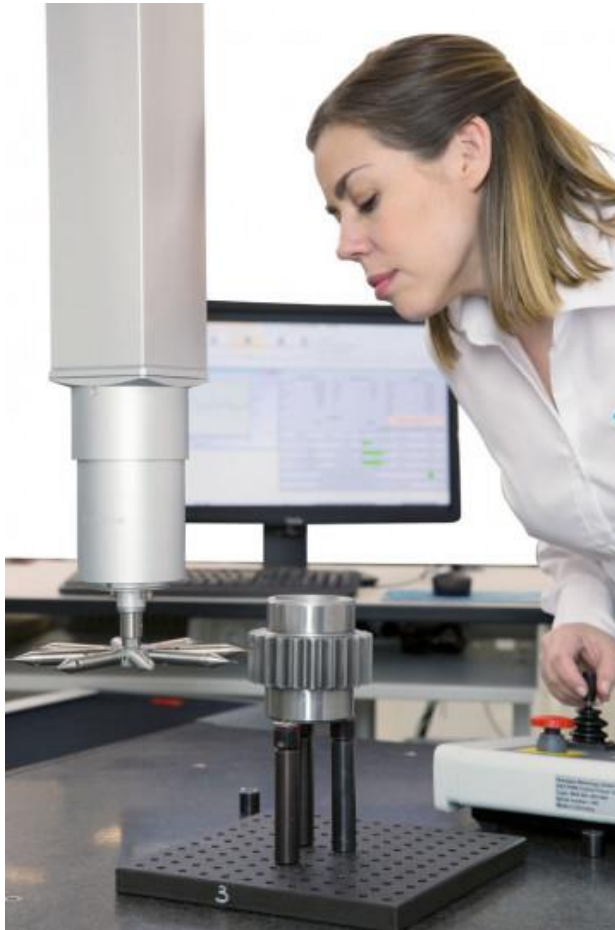

Construction : Quality controls



Construction : Final tests



HAND-OVER

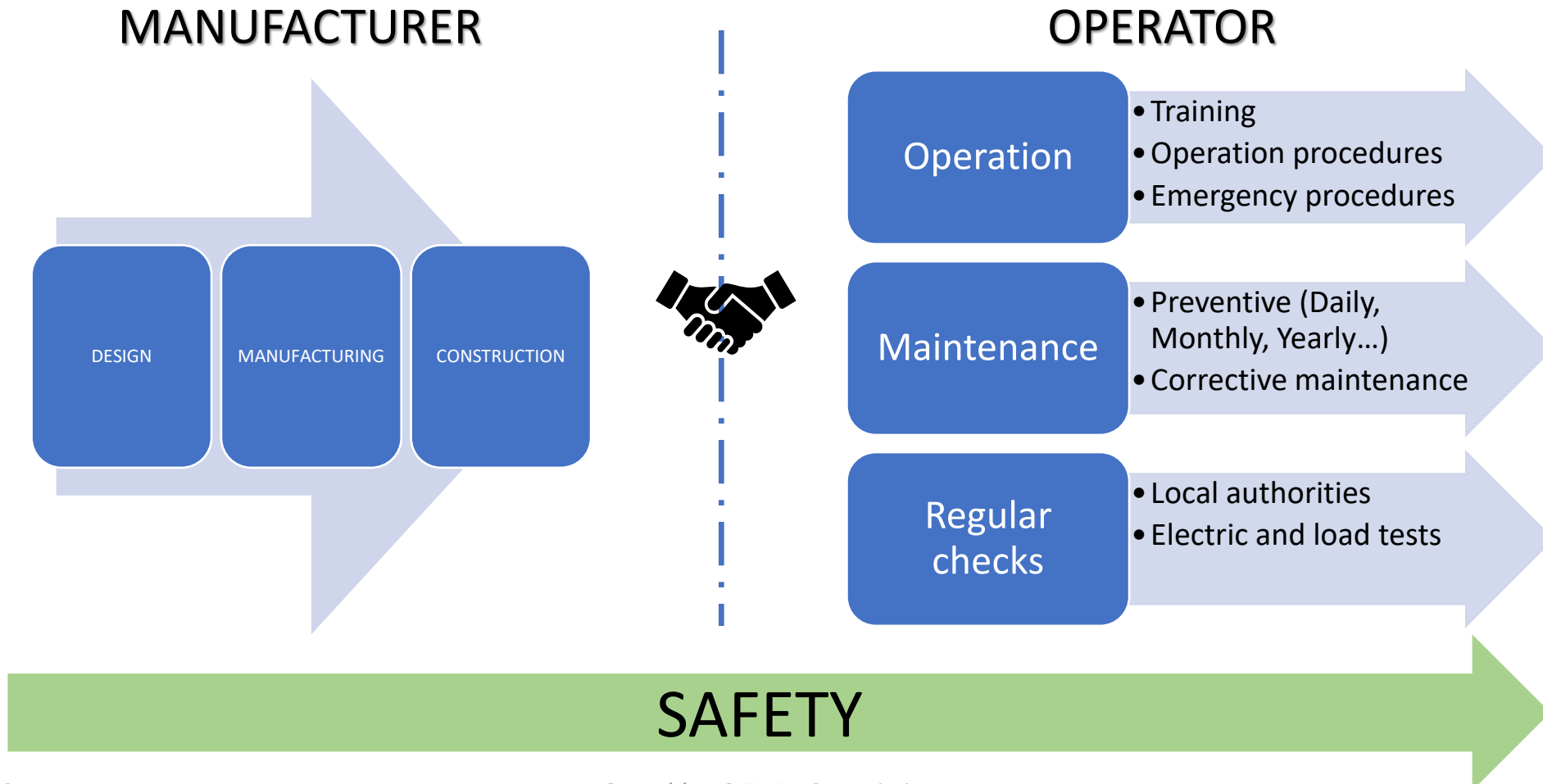



ROMA 1957
PARIS 1963
LUZERN 1969
WIEN 1975

MÜNCHEN 1981
GRENOBLE 1987
BARCELONA 1993
SAN FRANCISCO 1999

INNSBRUCK 2005
RIO DE JANEIRO 2011
BOLZANO-BOZEN 2017



Evolution du cadre normatif / *Evolution of the normative framework*



ROMA 1957
PARIS 1963
LUZERN 1969
WIEN 1975

MÜNCHEN 1981
GRENOBLE 1987
BARCELONA 1993
SAN FRANCISCO 1999

INNSBRUCK 2005
RIO DE JANEIRO 2011
BOLZANO-BOZEN 2017



Evolution du cadre normatif / *Evolution of the normative framework*

- Années 30

→ institution des premiers bureaux de contrôles nationaux et rédactions des premières réglementations nationales

- *In the '30*

→ *establishment of the first national control offices and drafting of the first national regulations*



ROMA 1957
PARIS 1963
LUZERN 1969
WIEN 1975

MÜNCHEN 1981
GRENOBLE 1987
BARCELONA 1993
SAN FRANCISCO 1999

INNSBRUCK 2005
RIO DE JANEIRO 2011
BOLZANO-BOZEN 2017



Evolution du cadre normatif / *Evolution of the normative framework*

by **G. Zoppo** - M. Joyeusaz

Evolution du cadre normatif / *Evolution of the normative framework*

Evolution of regulation

Italian term 'norma' means "triangle ruler"

results of experience and technological development according to the principle of the state of the art.

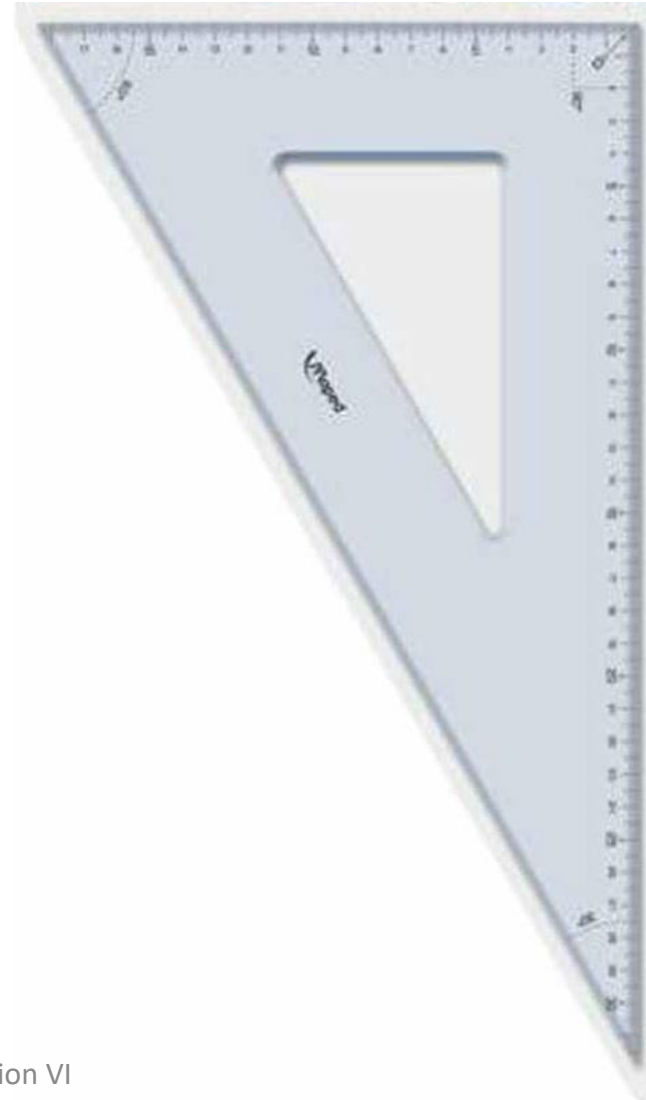

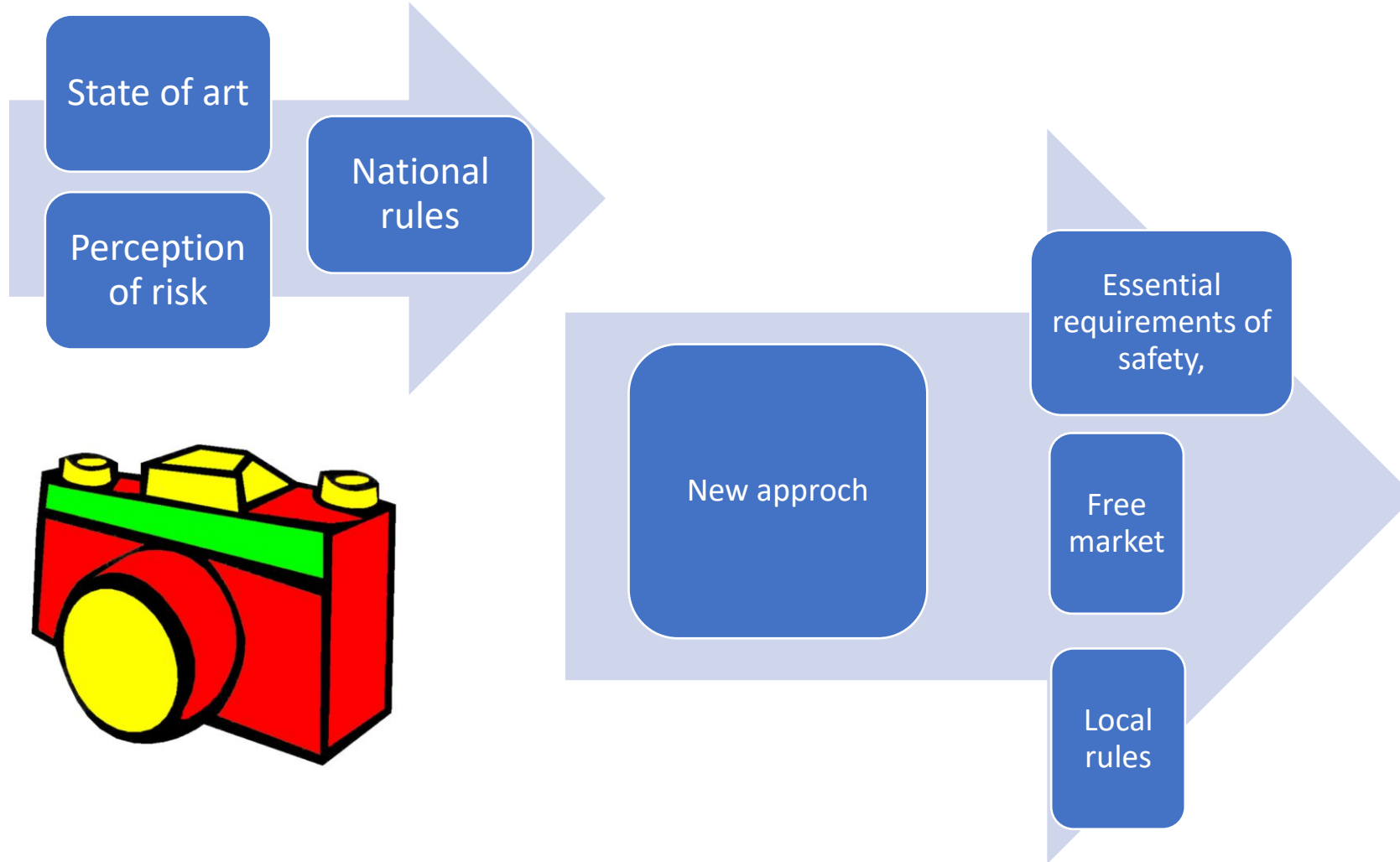

Evolution du cadre normatif / *Evolution of the normative framework*

Prescription

Guarantees respect for safety (the measure guarantees it)

Based on past experience

Simpler design and implementation

Performance

Need for risk analysis (the standard defines the level but not the value)

Need for experimentation

Complex design

Requires experience from the designer

Evolution du cadre normatif / Evolution of the normative framework

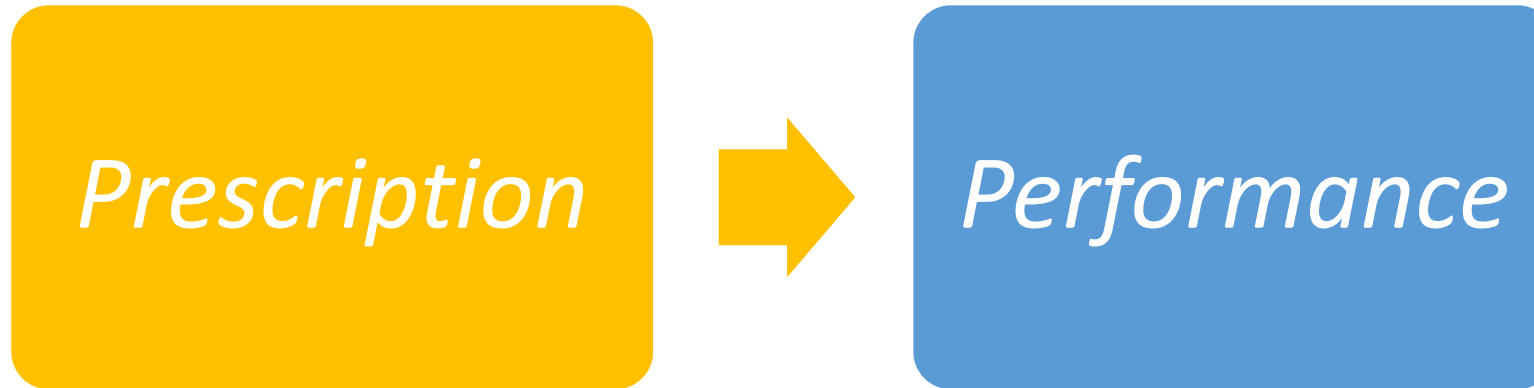

***Prescription:** which imposes a behavior by law, indicates precisely the necessary measure. It should be a complete rule. Photograph the state of the art.*

***Performance:** indicates a performance, a safety goal to be achieved, but does not impose limits. Based not on the obligation to adopt technical measures but on achieving results.*

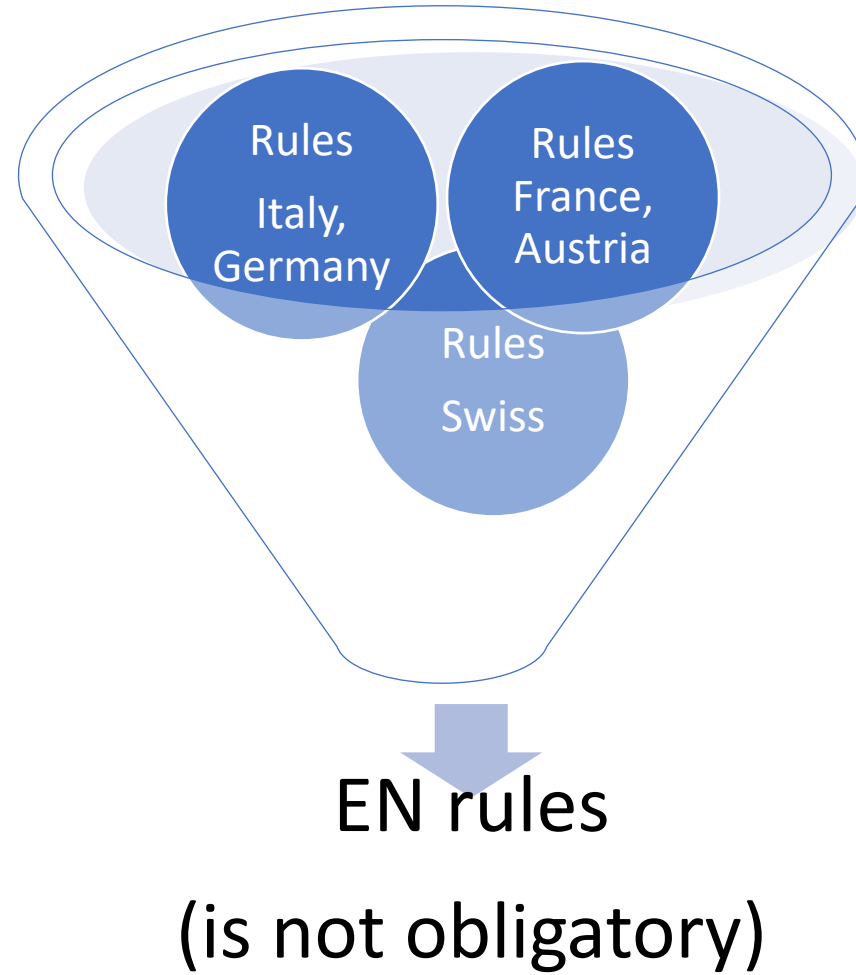



ROMA 1957
PARIS 1963
LUZERN 1969
WIEN 1975

MÜNCHEN 1981
GRENOBLE 1987
BARCELONA 1993
SAN FRANCISCO 1999

INNSBRUCK 2005
RIO DE JANEIRO 2011
BOLZANO-BOZEN 2017



Evolution du cadre normatif / *Evolution of the normative framework*

En résumé....

As a summary

➤ Situation actuelle en EUROPE / *Current situation in EUROPA* :

→ Normes CEN / *CEN standards*

➤ RESTE DU MONDE / *REST OF THE WORLD*





ROMA 1957
PARIS 1963
LUZERN 1969
WIEN 1975

MÜNCHEN 1981
GRENOBLE 1987
BARCELONA 1993
SAN FRANCISCO 1999

INNSBRUCK 2005
RIO DE JANEIRO 2011
BOLZANO-BOZEN 2017



Evolution du cadre normatif / *Evolution of the normative framework*

by G. Zoppo - **M. Joyeusaz**



ROMA 1957
PARIS 1963
LUZERN 1969
WIEN 1975

MÜNCHEN 1981
GRENOBLE 1987
BARCELONA 1993
SAN FRANCISCO 1999

INNSBRUCK 2005
RIO DE JANEIRO 2011
BOLZANO-BOZEN 2017



Evolution du cadre normatif / *Evolution of the normative framework*

OITAF

**ORGANIZZAZIONE INTERNAZIONALE TRASPORTI A FUNE
INTERNATIONAL ORGANIZATION FOR TRANSPORTATION BY ROPE**

- *was founded in Milan (IT) in 1959*
- *presently, 155 members from 35 countries have joined the organization*

Evolution du cadre normatif / *Evolution of the normative framework*

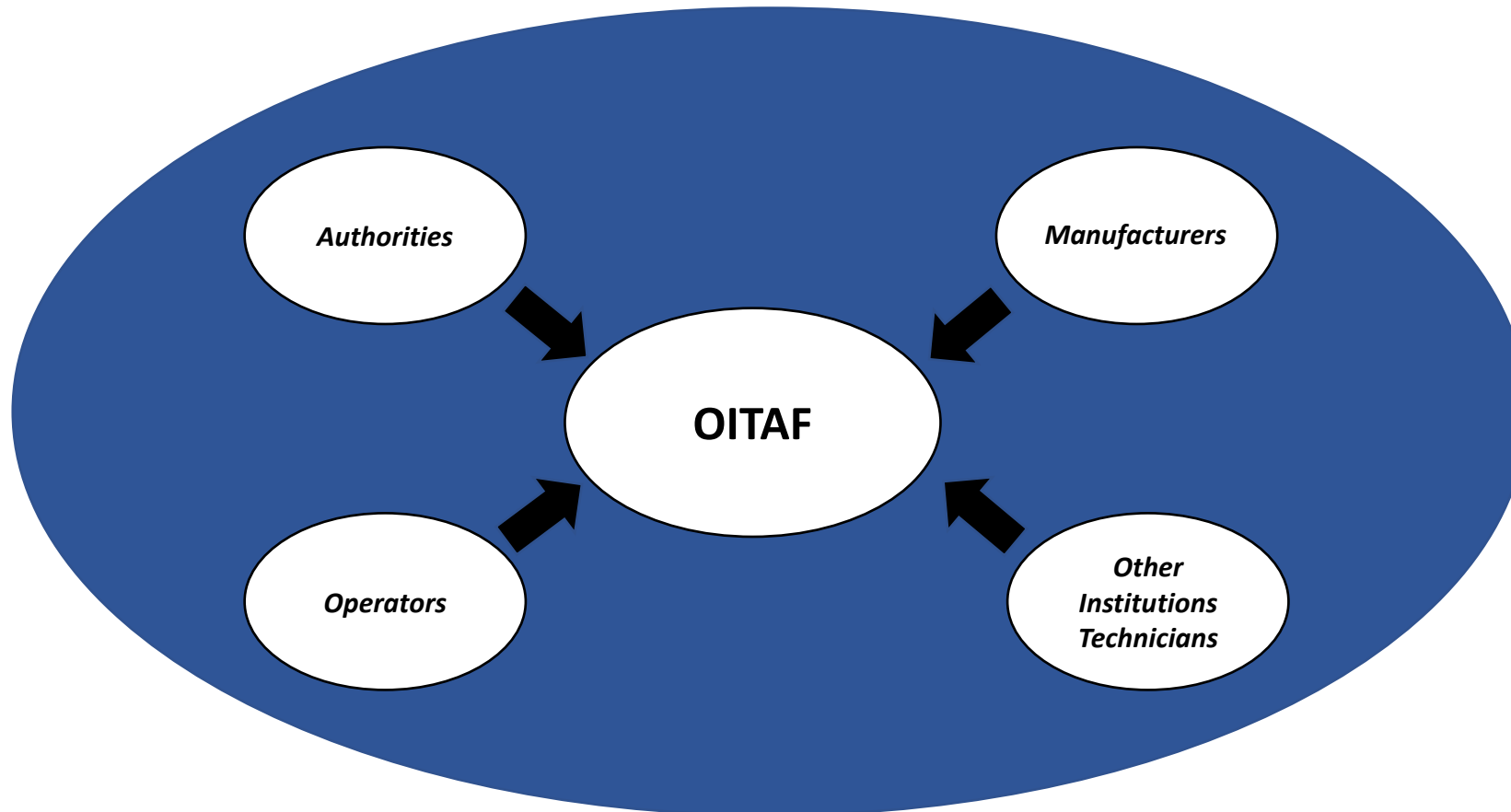



ROMA 1957
PARIS 1963
LUZERN 1969
WIEN 1975

MÜNCHEN 1981
GRENoble 1987
BARCELONA 1993
SAN FRANCISCO 1999

INNSBRUCK 2005
RIO DE JANEIRO 2011
BOLZANO-BOZEN 2017



Evolution du cadre normatif / Evolution of the normative framework

Purposes of OITAF

- ***Promotion of development and improvement of the ropeway business***
- ***Promotion of studies and experiences which support the development and improvement of the ropeway business***
- ***Promotion of standardization of the national rules in the field of ropeway transportation***
- ***Elaboration of standardized international guidelines, as well as setting up corresponding recommendations, for projection, construction, operation, control and maintenance of ropeways***
- ***Organization of international congresses for transportation by rope (every 6 years)***



ROMA 1957
PARIS 1963
LUZERN 1969
WIEN 1975

MÜNCHEN 1981
GRENOBLE 1987
BARCELONA 1993
SAN FRANCISCO 1999

INNSBRUCK 2005
RIO DE JANEIRO 2011
BOLZANO-BOZEN 2017



Evolution du cadre normatif / *Evolution of the normative framework*

OITAF Working Committees

- **W.C. n° I :** ***Technique of ropeway and technical recommendations***
 - **WORK GROUP: Non-public ropeways: Material transport ropeways and cable cranes**
 - **WORK GROUP: Non-public ropeways: Transportation of people and goods with reversible aerial ropeways**
- **W.C. n° II :** ***Characteristic and inspection of ropes***
- **W.C. n° III :** ***Electrical components respectively modules in ropeway installation***
- **W.C. n° IV :** ***Legal, administrative, economic and statistical matters***
- **W.C. n° VI :** ***Optimization of operation of ropeway systems***
- **W.C. n° VII :** ***Environment***



ROMA 1957
PARIS 1963
LUZERN 1969
WIEN 1975

MÜNCHEN 1981
GRENOBLE 1987
BARCELONA 1993
SAN FRANCISCO 1999

INNSBRUCK 2005
RIO DE JANEIRO 2011
BOLZANO-BOZEN 2017



Evolution du cadre normatif / *Evolution of the normative framework*

OITAF Working Committees

- ***Approximatevely 160 members participate voluntarily in the committees that meet every six months***
- ***Committee's outcomes published on the website www.oitaf.org recommendations***



ROMA 1957
PARIS 1963
LUZERN 1969
WIEN 1975

MÜNCHEN 1981
GRENOBLE 1987
BARCELONA 1993
SAN FRANCISCO 1999

INNSBRUCK 2005
RIO DE JANEIRO 2011
BOLZANO-BOZEN 2017



Exploitation / *Operations*

Part 1



ROMA 1957
PARIS 1963
LUZERN 1969
WIEN 1975

MÜNCHEN 1981
GRENOBLE 1987
BARCELONA 1993
SAN FRANCISCO 1999

INNSBRUCK 2005
RIO DE JANEIRO 2011
BOLZANO-BOZEN 2017



Formation / *Training*

by **A. Barès** – M. Ziegler



ROMA 1957
PARIS 1963
LUZERN 1969
WIEN 1975

MÜNCHEN 1981
GRENOBLE 1987
BARCELONA 1993
SAN FRANCISCO 1999

INNSBRUCK 2005
RIO DE JANEIRO 2011
BOLZANO-BOZEN 2017



Formation / Training

OBJECTIVES: lift staff **training** and their **evaluation**

- **Safety lift operation:** to know the machine and to take the right decisions
- **Dealing with customer:** to help, to be kind, to be right
- To adapt operation depending the **weather conditions**

Formation / Training

Example of Catalan Ski Resorts (SPAIN):

Lift training courses are organized by **ACEM** (Mountain resorts Catalan association):

- 2 weeks before season opening.
- There are 3 levels:
 - 1st level: Assistant
 - 2nd level: Fix grip lift and ground lifts driver
 - 3rd level: Detachable lift driver
- Done in a ski resort
 - To be close to all type of lifts for practical lessons
 - Using restaurant facilities as classrooms
- Courses duration: 5 days + exam 6th day
- Training accepted by the Ropeway Authorities.





ROMA 1957
 PARIS 1963
 LUZERN 1969
 WIEN 1975

MÜNCHEN 1981
 GRENOBLE 1987
 BARCELONA 1993
 SAN FRANCISCO 1999

INNSBRUCK 2005
 RIO DE JANEIRO 2011
 BOLZANO-BOZEN 2017



Formation / Training

Level 1: Lift Assistant	Level 2: Fix grip & ground lift driver	Level 3: Detachable grip lift driver
Mechanic Lift Equipment	Mechanic Lift Equipment	Mechanic Lift Equipment
Electrical Lift Equipment	Electrical Lift Equipment	Electrical Lift Equipment
Lift Operation	Lift Operation	Lift Operation
Norms & Regulations	Norms & Regulations	-
Customer Attention	Customer Attention	-
Weather forecast & Nivology	Weather forecast & Nivology	-
Work Safety	Work Safety	Work Safety
First Aid Care	First Aid Care	First Aid Care
Legal Terms	Legal Terms	Legal Terms
+ PRACTICAL LESSONS	+ PRACTICAL LESSONS	+ PRACTICAL LESSONS
+ EXAM	+ EXAM	+ EXAM



ROMA 1957
PARIS 1963
LUZERN 1969
WIEN 1975

MÜNCHEN 1981
GRENOBLE 1987
BARCELONA 1993
SAN FRANCISCO 1999

INNSBRUCK 2005
RIO DE JANEIRO 2011
BOLZANO-BOZEN 2017



Formation / Training

- **Lift mechanical and electric equipment , lift operation and practical lessons**
- *(Done by Ski Resort Lift operation and maintenance chiefs)*

- **Basic lift knowledge:** mechanical and electric parts and security controls
- **Control panel** and indications
- **To assembly emergency motor**
- **Operation daily controls:** before operation, first trip control and controls during operation
- **Lift access:** queue, load and unload areas, signalisation
- **Daily lift report**

”SAFETY is the priority”



ROMA 1957
PARIS 1963
LUZERN 1969
WIEN 1975

MÜNCHEN 1981
GRENOBLE 1987
BARCELONA 1993
SAN FRANCISCO 1999

INNSBRUCK 2005
RIO DE JANEIRO 2011
BOLZANO-BOZEN 2017



Formation / Training

- **First Aid Care (done by doctors from Mountain Hospitals)**
- The purpose is to what to do when there is an accident with people involved in the area of lift:
 - To protect the victim
 - To give a warning
 - To help
- To do a first valuation of injuries and inform



ROMA 1957
PARIS 1963
LUZERN 1969
WIEN 1975

MÜNCHEN 1981
GRENOBLE 1987
BARCELONA 1993
SAN FRANCISCO 1999

INNSBRUCK 2005
RIO DE JANEIRO 2011
BOLZANO-BOZEN 2017



Formation / Training

- Customer relationship (*Done by ski resorts marketing chiefs*)
- Lift operators must be in their working place and pay attention on customer safety, but also:
 - To give help when needed (loading area, kids, disabled people, ...)
 - Customer highly appreciate receiving **kind attention**



ROMA 1957
PARIS 1963
LUZERN 1969
WIEN 1975

MÜNCHEN 1981
GRENOBLE 1987
BARCELONA 1993
SAN FRANCISCO 1999

INNSBRUCK 2005
RIO DE JANEIRO 2011
BOLZANO-BOZEN 2017



Formation / Training

- **Norms and regulations** (*Done by the local ropeway authorities*)
 - Local, national and European norms
 - Constructor manuals
 - OITAF recommendations
- **Lift Operation rules (Règlement d'exploitation)** (*Done by the local ropeway authorities*)
 - Specific document per lift
 - Content:
 - Lift characteristics
 - Personnel missions and security norms at operation
 - Maintenance and controls
 - Self protection plan in case of emergency and evacuation plan if lift get blocked
 - How and when its needed inform the authorities

Formation / Training

- **Weather forecast and Nivology** (*Done by Avalanche & Weather forecast specialist*)
- **Mountain Weather conditions** can be adverse
 - To have better weather knowledge will help on take the right decisions during operation
 - Wind one of the biggest lift enemy.
- **Snow** is a complex and changing environment.
 - It can affect directly to safety operation
 - Lifts in ski resorts can be exposed to avalanches
 - Loading and unloading areas in chair and ground lifts



ROMA 1957
PARIS 1963
LUZERN 1969
WIEN 1975

MÜNCHEN 1981
GRENOBLE 1987
BARCELONA 1993
SAN FRANCISCO 1999

INNSBRUCK 2005
RIO DE JANEIRO 2011
BOLZANO-BOZEN 2017



Formation / Training

- **Work Safety** (*Done by occupational risk prevention mutual specialists*)
- Most frequent risks and preventive measures
- Individual protection equipment
- Safety protocol if there is a work accident
- What to do against fire & how to use correctly the fire protection equipment



ROMA 1957
PARIS 1963
LUZERN 1969
WIEN 1975

MÜNCHEN 1981
GRENOBLE 1987
BARCELONA 1993
SAN FRANCISCO 1999

INNSBRUCK 2005
RIO DE JANEIRO 2011
BOLZANO-BOZEN 2017



Formation / Training

- **Legal terms** (*Done by the catalan mountain police “Mossos d’Esquadra”*)
 - **How to act to be legally covered** when there is an accident or any problem with any costumer or passenger
 - To take all possible information that can be useful in case of judgment (pictures, witnesses, ...)



ROMA 1957
PARIS 1963
LUZERN 1969
WIEN 1975

MÜNCHEN 1981
GRENOBLE 1987
BARCELONA 1993
SAN FRANCISCO 1999

INNSBRUCK 2005
RIO DE JANEIRO 2011
BOLZANO-BOZEN 2017



Formation / Training



Formation / Training





ROMA 1957
PARIS 1963
LUZERN 1969
WIEN 1975

MÜNCHEN 1981
GRENOBLE 1987
BARCELONA 1993
SAN FRANCISCO 1999

INNSBRUCK 2005
RIO DE JANEIRO 2011
BOLZANO-BOZEN 2017



Formation / Training





ROMA 1957
PARIS 1963
LUZERN 1969
WIEN 1975

MÜNCHEN 1981
GRENOBLE 1987
BARCELONA 1993
SAN FRANCISCO 1999

INNSBRUCK 2005
RIO DE JANEIRO 2011
BOLZANO-BOZEN 2017



Formation / Training





ROMA 1957
PARIS 1963
LUZERN 1969
WIEN 1975

MÜNCHEN 1981
GRENOBLE 1987
BARCELONA 1993
SAN FRANCISCO 1999

INNSBRUCK 2005
RIO DE JANEIRO 2011
BOLZANO-BOZEN 2017



Formation / Training





ROMA 1957
PARIS 1963
LUZERN 1969
WIEN 1975

MÜNCHEN 1981
GRENOBLE 1987
BARCELONA 1993
SAN FRANCISCO 1999

INNSBRUCK 2005
RIO DE JANEIRO 2011
BOLZANO-BOZEN 2017



Formation / Training





ROMA 1957
PARIS 1963
LUZERN 1969
WIEN 1975

MÜNCHEN 1981
GRENOBLE 1987
BARCELONA 1993
SAN FRANCISCO 1999

INNSBRUCK 2005
RIO DE JANEIRO 2011
BOLZANO-BOZEN 2017



Formation / Training

All lift employees need: **To pass the exam, and...**

- To pass a **personal interview**
 - Medical validation, attitude and aptitude
- **Specific lift training**
 - each lift has its particularities
- Yearly **Recycling Training**
 - to refresh lift knowledge every season at work place a recycling training is done



ROMA 1957
PARIS 1963
LUZERN 1969
WIEN 1975

MÜNCHEN 1981
GRENOBLE 1987
BARCELONA 1993
SAN FRANCISCO 1999

INNSBRUCK 2005
RIO DE JANEIRO 2011
BOLZANO-BOZEN 2017



Formation / *Training*

by A. Barès - **M.Ziegler**

Formation / Training

Education, training, goals

- ***A core task of Swiss ropeways is the basic education and further trainings.***
- ***The employees of Swiss cableways have the possibility to get a certified education on all levels.***



Education concept

LAW

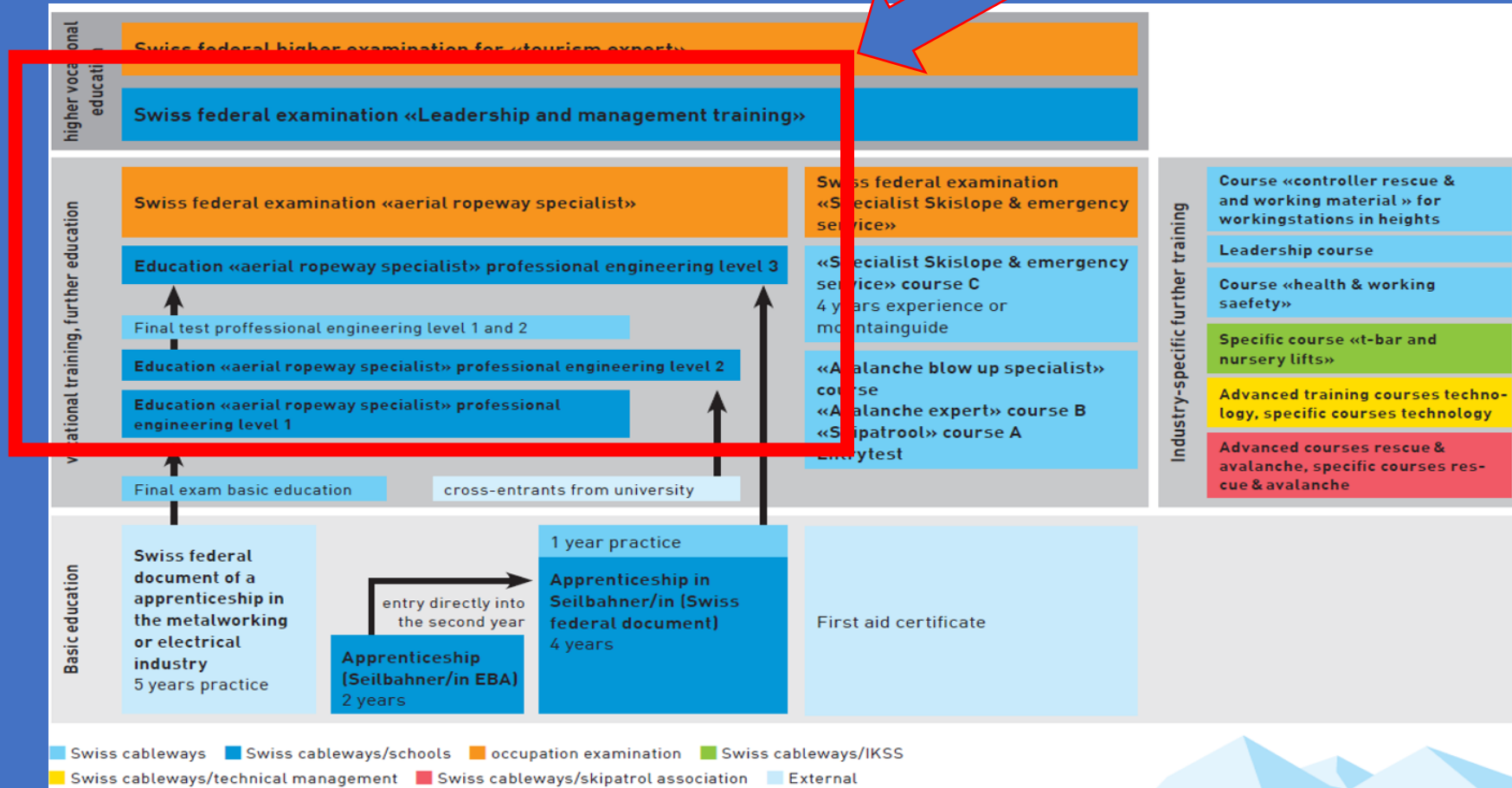

LAW, Cableways Specialist - Federal Diploma of Higher Education

- Art. 46a¹ Technische Leiter und Leiterinnen

¹ Technische Leiter und Leiterinnen von eidgenössisch konzessionierten Anlagen müssen:

- a. die Berufsprüfung als Seilbahnfachmann oder Seilbahnfachfrau mit eidgenössischem Fachausweis abgeschlossen haben; und
- b. über eine zweijährige seilbahnspezifische Betriebserfahrung verfügen.



- Art. 46a¹ Capitecnici

¹ I capitecnici di impianti soggetti a concessione federale devono:

- a. possedere un attestato professionale federale di specialista degli impianti di trasporto a fune; e
- b. disporre di due anni di esperienza d'esercizio nel settore degli impianti di trasporto a fune.

- Art. 46a¹ Chefs techniques

¹ Les chefs techniques des installations à câbles au bénéfice d'une concession fédérale doivent:

- a. être titulaires d'un brevet fédéral de spécialiste en installations de transport à câbles, et
- b. disposer de plus de deux ans d'expérience dans l'exploitation des installations à câbles.



ROMA 1957
PARIS 1963
LUZERN 1969
WIEN 1975

MÜNCHEN 1981
GRENOBLE 1987
BARCELONA 1993
SAN FRANCISCO 1999

INNSBRUCK 2005
RIO DE JANEIRO 2011
BOLZANO-BOZEN 2017



Topics, Cableways Specialist - Federal Diploma of Higher Education

Mo 08:00 am till Fr. 12:00 am 8 less /day													
36 less. / week		1,	2,	3,	4,	5,	6,	7,	8,	9,			
Subjects, indicative targets:		week	week	week	week	week	week	week	week	week	theorie		
1.1.2.	<u>corrosion</u>			2							2		
1.1.3.	<u>materials, characteristics</u>	4	4	4							12		
1.1.6.	<u>Drawing, standarts norms (mecanical / hydraulic)</u>	6	2	2		1					11		
1.1.6.	<u>Draws of constructions</u>							8			8	33	28
1.2.1.	<u>Technical calculation basics</u>	2	2								4		
1.2.2.	<u>Force transmission, movement, vibration</u>		6	4		3	2	2	4	2	23	27	28
1.3.1.	<u>Operating condition</u>	4									4		
1.3.2.	<u>Work safety, fire protection, first aid</u>	4									4		
1.3.3.	<u>Weather</u>			4				4			8		
1.3.7.	<u>Rescue favilities</u>							2	0	8	10	26	38
1.4.1.	<u>Ropeway systems, station facilities (handling)</u>	6	6	4							16		
1.4.2.	<u>Mechanical systems, cableway installations</u>				8	7	4				19		
1.4.3.	<u>Mecanical komponenets of cableway installations</u>			2	2		10		5		19		
1.4.4.	<u>Fluid engineering</u>				4	6	7				17		
1.4.5.	Combustion engines										0	71	74



1.4.5. Combustion engines
Seilbahnen Schweiz
Remontées Mécaniques Suisses
Funivie Svizzere
Pendicularas Svizras

1.4.3. Mecanical komponenets of cableway installations

Topics, Cableways Specialist - Federal Diploma of Higher Education

1.5.1.	Basics <u>electrotechnic and electronic</u>	7	7	6	8						28		
1.5.2.	Knowledge of <u>systems and equipment</u>				8	2	1	2	4		17		
1.5.3.	Knowledge of <u>mesuring instruments</u>		4				4				8		
1.5.4.	Knowledge <u>handling systems and equipment</u>					4	2				6		
1.5.5.	Knowledge and <u>handling of control elements</u>							10	8	2	20	79	82
1.6.1.	<u>Geological basic and forces</u>							2	2	2	6		
1.6.2.	<u>Properties of materials</u>								4		4		
1.6.3.	<u>Properties and functions of constructions</u>								2	3	5	15	16
1.7.1.	Basics <u>repair services</u>							4			4		
1.7.2.	<u>Repair services of mecanical komponents</u>			4	2	5			4	1	16		
1.7.3.	<u>Repair services of electric and electrotechnical parts</u>							4		4	8		
1.7.4.	<u>Lubricants</u>		2			2					4		
1.7.5.	<u>Cleaning, treatment of rooms equipement and machines</u>				2	4					6	38	32
2: 3	Introduction, finish	1		1			1			1	4		
	Learning technique, <u>methods, social competence</u>	4		2			1			1	8		
	Excursion <u>different ropeway systems</u>										0		
	Excursion production of <u>cables</u>									8	8		
											0	20	24
	Total <u>lessons per week</u>	38	33	35	34	34	32	38	33	32	309	309	
	<u>Test after week 3. 6. and 9. courseweek</u>			8			8			8			
	Lessons	36	36	36	36	36	36	36	36	36		324	322
	Courseweek Nr.	1	2	3	4	5	6	7	8	9			

Trainings, owner of a valid diplomas (2015 till now)

- 1750 skipatrol & avalanche blaster (experts)
- 155 Ski Patrol Chief, Federal Diploma higher Education
- 1025 snow grooming vehicle Drivers
- 400 Cableways Specialist Federal Diploma of higher Education
- 156 ski lift experts
- 450 Funicular Technician, Federal Diploma VET (apprenticeship)
- Clamp Socket, Casting Head
- Health and Safety
- Course for board of directors and CEO's of ropeways
- Electro technical courses
- Process management





ROMA 1957
PARIS 1963
LUZERN 1969
WIEN 1975

MÜNCHEN 1981
GRENOBLE 1987
BARCELONA 1993
SAN FRANCISCO 1999

INNSBRUCK 2005
RIO DE JANEIRO 2011
BOLZANO-BOZEN 2017



Partnership

120'000 participant lessons per year are provided by the education centre in Meiringen including several courses in cooperation with :

- Professionals from the cableway operators
- Manufacturer's professionals
- VTK-UTC (association technical managers)
- Ropeway companies (infrastructure)
- Legislator

Questions?

“There is only one thing in the long run more expensive than education: no education.” – JFK

marc.ziegler@seilbahnen.org

www.seilbahnen.org





ROMA 1957
PARIS 1963
LUZERN 1969
WIEN 1975

MÜNCHEN 1981
GRENOBLE 1987
BARCELONA 1993
SAN FRANCISCO 1999

INNSBRUCK 2005
RIO DE JANEIRO 2011
BOLZANO-BOZEN 2017



Contrôles & Maintenance / *Checks & Maintenance*

by **A. Barès** – G. Zoppo – R. Dietsch



ROMA 1957
PARIS 1963
LUZERN 1969
WIEN 1975

MÜNCHEN 1981
GRENOBLE 1987
BARCELONA 1993
SAN FRANCISCO 1999

INNSBRUCK 2005
RIO DE JANEIRO 2011
BOLZANO-BOZEN 2017



Contrôles et maintenance / *Check and maintenance*

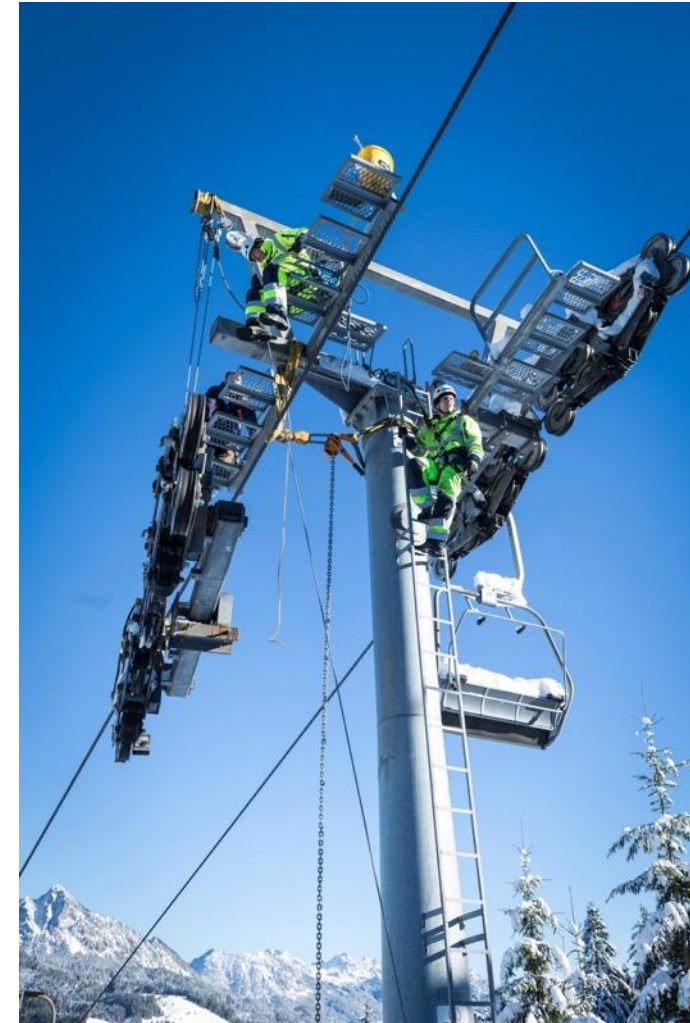



ROMA 1957
PARIS 1963
LUZERN 1969
WIEN 1975

MÜNCHEN 1981
GRENOBLE 1987
BARCELONA 1993
SAN FRANCISCO 1999

INNSBRUCK 2005
RIO DE JANEIRO 2011
BOLZANO-BOZEN 2017



Contrôles et maintenance / *Check and maintenance*

- **Controls and maintenance will:**
 - Maximize
 - **Safety**
 - **Lift and equipment life**
 - Minimize
 - **Non-voluntary stops**
 - **Operation costs**
- Controls and maintenance require **employee training**
- All **control & inspection** tasks must be **registered and signed**



ROMA 1957
PARIS 1963
LUZERN 1969
WIEN 1975

MÜNCHEN 1981
GRENOBLE 1987
BARCELONA 1993
SAN FRANCISCO 1999

INNSBRUCK 2005
RIO DE JANEIRO 2011
BOLZANO-BOZEN 2017



Contrôles et maintenance / *Check and maintenance*

- Controls and maintenance must be done according a **maintenance plan** considering:
 - **Constructor manuals**
 - **Norms** (CEN European norms)
 - **National guides** (ex. France: STRMTG)
 - **OITAF recommendations**
 - **Operation experience**



ROMA 1957
PARIS 1963
LUZERN 1969
WIEN 1975

MÜNCHEN 1981
GRENOBLE 1987
BARCELONA 1993
SAN FRANCISCO 1999

INNSBRUCK 2005
RIO DE JANEIRO 2011
BOLZANO-BOZEN 2017



Contrôles et maintenance / *Check and maintenance*

- **Maintenance (UNE-EN 1709:2020)**
 - During season (In operation):
 - **Daily control** (before operation, test trip and during operation)
 - **Weekly inspection** (required by some constructors)
 - **Monthly inspection** (contains rope visual inspection)
 - **Grips displacement** (in fix grip lifts)
 - After season (Out of operation):
 - **Annual inspection**
 - **Rope inspection**
 - **Grips inspection**
 - **Large inspection** (including non destructive tests)
 - 1st at 15 years or 30.000 h
 - then: every 10 years or 20.000 h

Contrôles et maintenance / *Check and maintenance*

- **Operation hours vs. Maintenance hours**

- **Example:** standard detachable chair lift in a Ski resort operating in a winter season
 - **1.120 h Operation hours per season** (average) :
 - Approx: 8h/day during 140 days
 - **1.460 man-hours of Maintenance :**
 - 1 man-hour every day control (in operation): **140h/season**
 - 4 man-hour every week inspection (in operation): **80h/season**
 - 10 man-hour every monthly inspection (in operation): **40h/season**
 - Year inspection (out of operation season): **1200h/season**



ROMA 1957
PARIS 1963
LUZERN 1969
WIEN 1975

MÜNCHEN 1981
GRENOBLE 1987
BARCELONA 1993
SAN FRANCISCO 1999

INNSBRUCK 2005
RIO DE JANEIRO 2011
BOLZANO-BOZEN 2017



Contrôles et maintenance / *Check and maintenance*



27.04.2022

Grenoble - OITAF – Commission VI

130



ROMA 1957
PARIS 1963
LUZERN 1969
WIEN 1975

MÜNCHEN 1981
GRENOBLE 1987
BARCELONA 1993
SAN FRANCISCO 1999

INNSBRUCK 2005
RIO DE JANEIRO 2011
BOLZANO-BOZEN 2017



Contrôles et maintenance / *Check and maintenance*





ROMA 1957
PARIS 1963
LUZERN 1969
WIEN 1975

MÜNCHEN 1981
GRENOBLE 1987
BARCELONA 1993
SAN FRANCISCO 1999

INNSBRUCK 2005
RIO DE JANEIRO 2011
BOLZANO-BOZEN 2017



Contrôles et maintenance / *Check and maintenance*



Contrôles et maintenance / *Check and maintenance*





ROMA 1957
PARIS 1963
LUZERN 1969
WIEN 1975

MÜNCHEN 1981
GRENOBLE 1987
BARCELONA 1993
SAN FRANCISCO 1999

INNSBRUCK 2005
RIO DE JANEIRO 2011
BOLZANO-BOZEN 2017



Contrôles et maintenance / *Check and maintenance*





ROMA 1957
PARIS 1963
LUZERN 1969
WIEN 1975

MÜNCHEN1981
GRENOBLE 1987
BARCELONA 1993
SAN FRANCISCO 1999

INNSBRUCK 2005
RIO DE JANEIRO 2011
BOLZANO-BOZEN 2017



Contrôles et maintenance / *Check and maintenance*



Contrôles et maintenance / *Check and maintenance*





ROMA 1957
PARIS 1963
LUZERN 1969
WIEN 1975

MÜNCHEN 1981
GRENOBLE 1987
BARCELONA 1993
SAN FRANCISCO 1999

INNSBRUCK 2005
RIO DE JANEIRO 2011
BOLZANO-BOZEN 2017



Contrôles et maintenance / *Check and maintenance*





ROMA 1957
PARIS 1963
LUZERN 1969
WIEN 1975

MÜNCHEN 1981
GRENOBLE 1987
BARCELONA 1993
SAN FRANCISCO 1999

INNSBRUCK 2005
RIO DE JANEIRO 2011
BOLZANO-BOZEN 2017



Contrôles et maintenance / *Check and maintenance*





ROMA 1957
PARIS 1963
LUZERN 1969
WIEN 1975

MÜNCHEN 1981
GRENOBLE 1987
BARCELONA 1993
SAN FRANCISCO 1999

INNSBRUCK 2005
RIO DE JANEIRO 2011
BOLZANO-BOZEN 2017



Contrôles & Maintenance / *Checks & Maintenance*

by A. Barès – **G. Zoppo** – R. Dietsch



ROMA 1957
PARIS 1963
LUZERN 1969
WIEN 1975

MÜNCHEN 1981
GRENOBLE 1987
BARCELONA 1993
SAN FRANCISCO 1999

INNSBRUCK 2005
RIO DE JANEIRO 2011
BOLZANO-BOZEN 2017



Contrôles et maintenance / *Check and maintenance*

Percentage of anomalies
in the various inspections
over the years
(VdA 1990-2010)

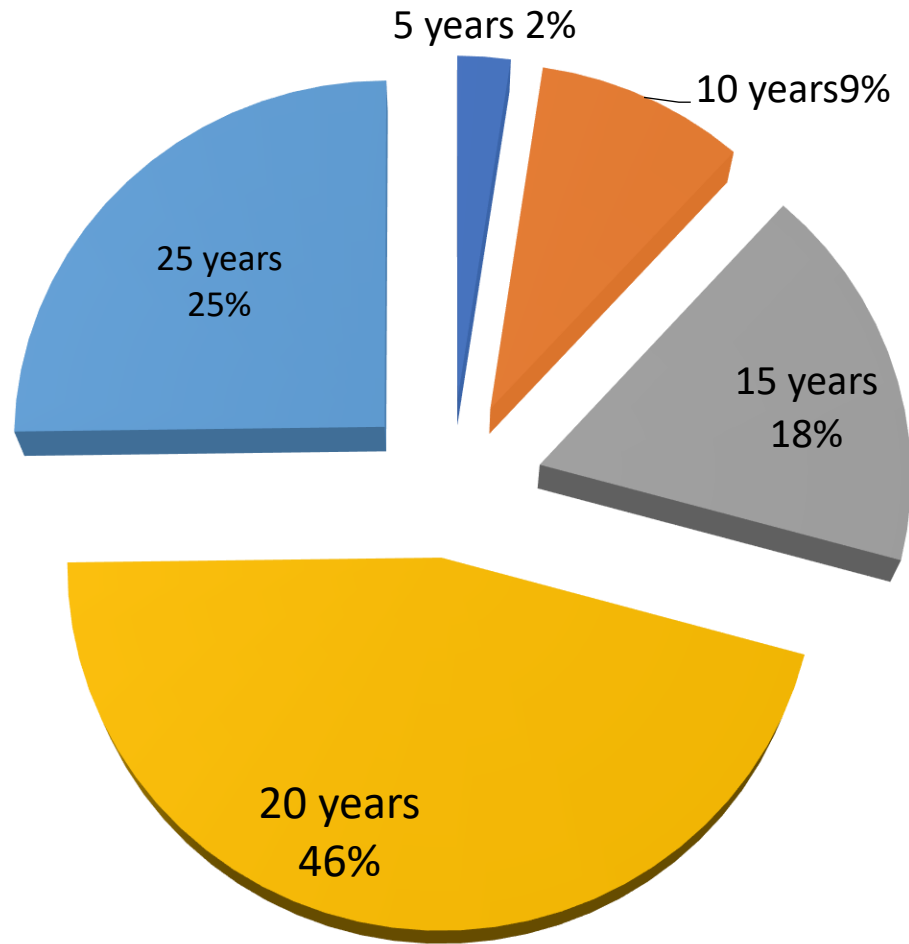



ROMA 1957
PARIS 1963
LUZERN 1969
WIEN 1975

MÜNCHEN 1981
GRENOBLE 1987
BARCELONA 1993
SAN FRANCISCO 1999

INNSBRUCK 2005
RIO DE JANEIRO 2011
BOLZANO-BOZEN 2017



Contrôles et maintenance / *Check and maintenance*

Control and maintenance register

For each component, the register must contain :

- the type, frequency and method of control and maintenance,*
- the reference to the section of the M.U.M. where the operations that must be carried out are fully described,*
- a space for recording the date of the intervention*
- the identification of the maintenance technician*
- a free field for recording notes or anomalies found during the operations and the related actions taken.*



ROMA 1957
PARIS 1963
LUZERN 1969
WIEN 1975

MÜNCHEN 1981
GRENOBLE 1987
BARCELONA 1993
SAN FRANCISCO 1999

INNSBRUCK 2005
RIO DE JANEIRO 2011
BOLZANO-BOZEN 2017



Which use?

- basis for changing maintenance frequencies (through the use and management of recorded data), for example, for urban plants whose maintenance is not yet standardized.
- It is possible to check what is done and therefore allows the supervisory authority to give judgment to authorize the continuation of the operation and the extension of the life of the plant
- Defines responsibilities and clarifies who did what (see accidents)
- Allows to trace anomalies on similar systems and transmit information otherwise not accessible to more operators



ROMA 1957
PARIS 1963
LUZERN 1969
WIEN 1975

MÜNCHEN 1981
GRENOBLE 1987
BARCELONA 1993
SAN FRANCISCO 1999

INNSBRUCK 2005
RIO DE JANEIRO 2011
BOLZANO-BOZEN 2017



Contrôles & Maintenance / *Checks & Maintenance*

by A. Barès – G. Zoppo – **R. Dietsch**



ROMA 1957
PARIS 1963
LUZERN 1969
WIEN 1975

MÜNCHEN 1981
GRENOBLE 1987
BARCELONA 1993
SAN FRANCISCO 1999

INNSBRUCK 2005
RIO DE JANEIRO 2011
BOLZANO-BOZEN 2017



Contrôles et maintenance/ *Checks and maintnance*

Independent frequent Inspections

Richard Dietzsch
TÜV SÜD Industrie Service GmbH

Contrôles et maintenance/ *Checks and maintenance*

Inspections – European countries

Based on CEN Standards, with additional national and/or state laws and directives, **focused on passenger ropeways** :

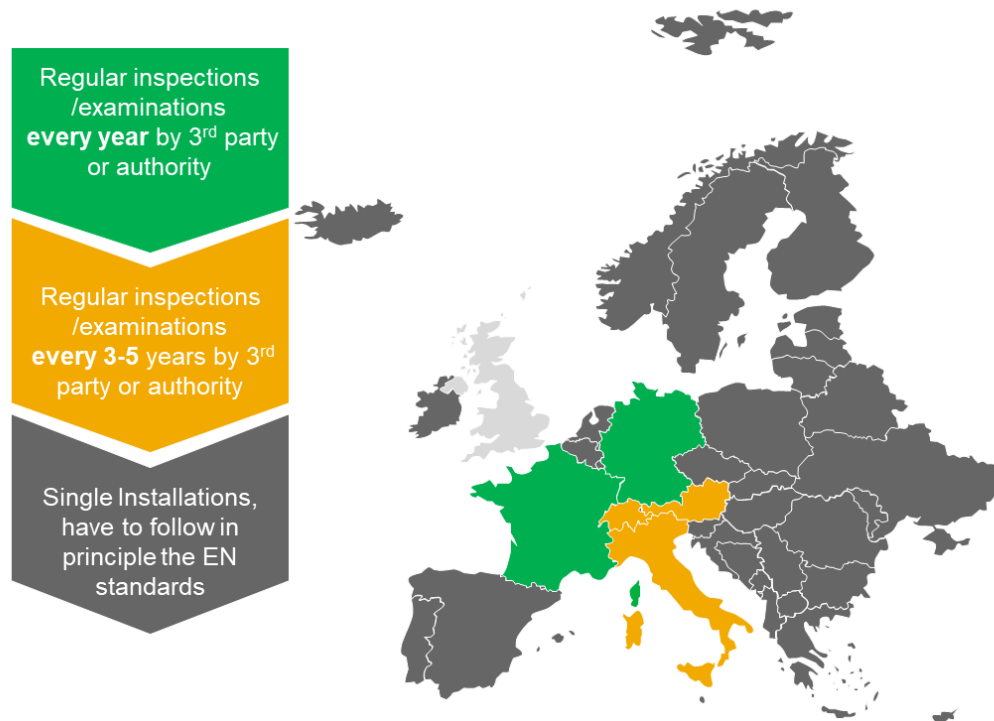

- **Alpine Countries** with most experience and **long-term history** with ropeway standards
- **National differences** in operator obligations and responsibilities, especially in **Italy, Austria and Switzerland**
- **Big national differences** regarding the requirements **on independence of 3rd Party** processes

Contrôles et maintenance/ Checks and maintenance

Regular Ropeway Inspections in Germany

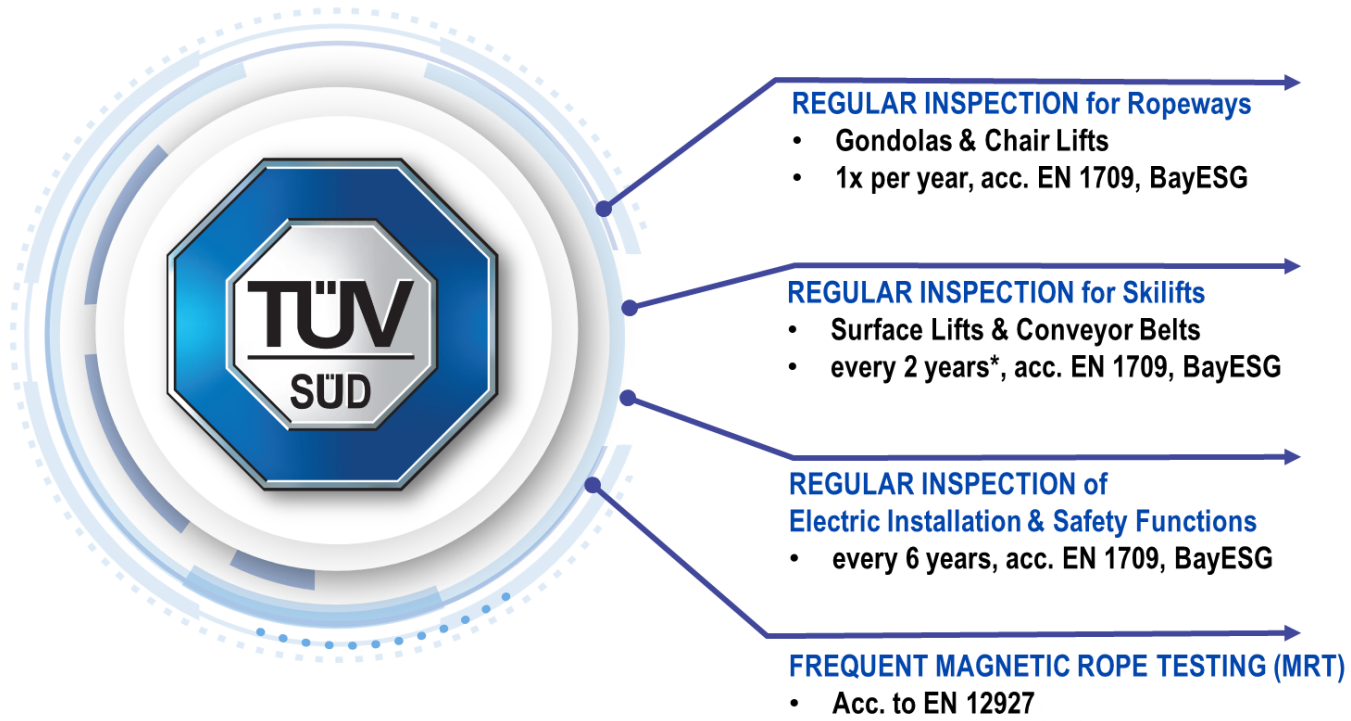

*only for winter operation, full year operation e.g. SkiDome or Bike Park, 1x per year



Contrôles et maintenance/ *Checks and maintenance*

Established
systematic of risk
minimization:





ROMA 1957
PARIS 1963
LUZERN 1969
WIEN 1975

MÜNCHEN 1981
GRENOBLE 1987
BARCELONA 1993
SAN FRANCISCO 1999

INNSBRUCK 2005
RIO DE JANEIRO 2011
BOLZANO-BOZEN 2017





ROMA 1957
PARIS 1963
LUZERN 1969
WIEN 1975

MÜNCHEN 1981
GRENOBLE 1987
BARCELONA 1993
SAN FRANCISCO 1999

INNSBRUCK 2005
RIO DE JANEIRO 2011
BOLZANO-BOZEN 2017



Exploitation / *Operations*

Part 2



ROMA 1957
PARIS 1963
LUZERN 1969
WIEN 1975

MÜNCHEN 1981
GRENOBLE 1987
BARCELONA 1993
SAN FRANCISCO 1999

INNSBRUCK 2005
RIO DE JANEIRO 2011
BOLZANO-BOZEN 2017



Système de Gestion de la Sécurité / *Security Management System*

by T. Chatelus – Jean-Claude Dupla - Fabrice Estieu & Enric Barbier

Système de Gestion de la Sécurité/ *Safety Management System*

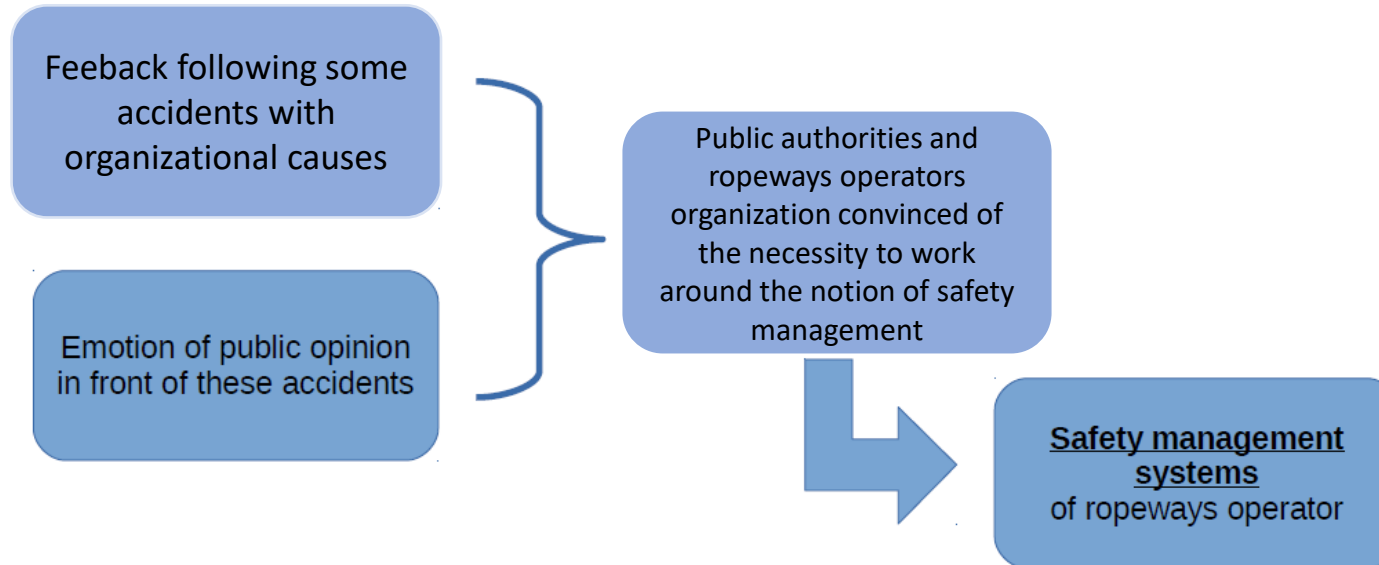

- ISO 9001 certificate not adapted for safety answers

Système de Gestion de la Sécurité/ *Safety Management System*

- Obligation to the french ropeways operators to develop a SMS
- Operators of aerial ropeways, funiculars, surface lifts, carpets are also involved

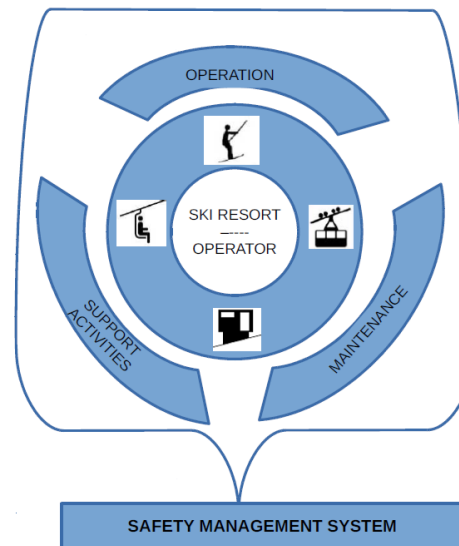

Système de Gestion de la Sécurité/ *Safety Management System*

8 themes must be handled



Système de Gestion de la Sécurité/ *Safety Management System*

→ La base du **Règlement de Sécurité** de l'Exploitation des transports publics guidés urbains a servi de support pour les Remontées Mécaniques des stations et la création du SGS adapté à l'activité « Montagne »



Système de Gestion de la Sécurité/ *Safety Management System*

➔ Passerelle entre RM stations montagne et transport urbain
(transports guidés et câbles urbains)

Règlement de Sécurité de l'Exploitation des transports publics guidés urbains	Système de la Gestion de la Sécurité pour les exploitants de remontées mécaniques en zone de montagne
Chapitre 1 Objet du règlement de sécurité d'Exploitation	Chapitre 1 Missions de l'exploitant
Chapitre 2 Description de l'organisation de l'exploitant	Chapitre 2 Organisation de l'exploitant
Chapitre 3 Description des conditions d'exploitation du système	Chapitre 3 Règles d'exploitation
Chapitre 4 Moyens d'information des usagers en matière de sécurité	Chapitre 4 Maintenance
Chapitre 5 Moyens de lutte contre les actes de malveillance pouvant affecter la sécurité	Chapitre 5 Organisation du retour d'expérience
Chapitre 6 Politique de maintenance	Chapitre 6 Gestion des compétences
Chapitre 7 Formation du personnel exploitation et maintenance	Chapitre 7 Dispositif permanent de contrôle interne et de suivi de la sécurité
Chapitre 8 Éléments relatifs à la qualité	Chapitre 8 Gestion documentaire
Chapitre 9 Dispositif permanent de contrôle et d'évaluation du niveau de sécurité	
Chapitre 10 Relations avec le service en chargé du contrôle à l'occasion d'accidents ou d'incidents d'exploitation	



ROMA 1957
PARIS 1963
LUZERN 1969
WIEN 1975

MÜNCHEN 1981
GRENOBLE 1987
BARCELONA 1993
SAN FRANCISCO 1999

INNSBRUCK 2005
RIO DE JANEIRO 2011
BOLZANO-BOZEN 2017



Systeme de Gestion de la Sécurité/ *Safety Management System*

En Pratique

- Ce qui en résulte pour les exploitants et pour les autorités de contrôle
- Réflexions internes à chaque société afin de s'adapter à ce nouveau contexte
- Enjeu fort de travail avec les équipes pour l'appropriation de cet outil
- Pour certains exploitants, arrêt de la certification ISO 9001 qui seule n'apportait pas de garantie suffisante aux exigences du SGS

Benefits of SMS in practice

- *For operators and control authorities :*
 - *Internal reflections at each company in order to adapt to this new context*
 - *Strong challenge of working with the teams for the appropriation of this tool*
 - *For some operators, discontinuation of ISO 9001 certification, which alone did not provide sufficient guarantee of SMS requirements*



ROMA 1957
PARIS 1963
LUZERN 1969
WIEN 1975

MÜNCHEN 1981
GRENOBLE 1987
BARCELONA 1993
SAN FRANCISCO 1999

INNSBRUCK 2005
RIO DE JANEIRO 2011
BOLZANO-BOZEN 2017



Système de Gestion de la Sécurité/ *Safety Management System*

En conclusion :

- ***Une meilleure intégration du retour d'expérience dans le dispositif afin d'améliorer le niveau de sécurité***
- ***Un système audité par des personnes agréées ou par le service du ministère des transports, donc des audits plus ciblés sur les problématiques de sécurité***
- ***Un système adapté à chaque exploitant qui peut mettre en place une organisation adaptée à son contexte spécifique***

In conclusion :

- ***A better integration of experience feedback into the system in order to improve the level of safety.***
- ***A system audited by approved persons or by the service of the Ministry of Transportation, therefore more targeted audits on safety issues.***
- ***A system adapted to each operator who can set up an organization adapted to his specific context.***



ROMA 1957
PARIS 1963
LUZERN 1969
WIEN 1975

MÜNCHEN 1981
GRENOBLE 1987
BARCELONA 1993
SAN FRANCISCO 1999

INNSBRUCK 2005
RIO DE JANEIRO 2011
BOLZANO-BOZEN 2017



REX / Return of experience



ROMA 1957
PARIS 1963
LUZERN 1969
WIEN 1975

MÜNCHEN 1981
GRENOBLE 1987
BARCELONA 1993
SAN FRANCISCO 1999

INNSBRUCK 2005
RIO DE JANEIRO 2011
BOLZANO-BOZEN 2017



REX / Return of experience

Gestion de l'embarquement sur les télésièges / Management of boarding on chairlifts

by J.C. Dupla - E. Barbier & F. Estieu - M. Moyes



ROMA 1957
PARIS 1963
LUZERN 1969
WIEN 1975

MÜNCHEN 1981
GRENoble 1987
BARCELONA 1993
SAN FRANCISCO 1999

INNSBRUCK 2005
RIO DE JANEIRO 2011
BOLZANO-BOZEN 2017



Gestion de l'embarquement sur les télésièges / Management of boarding on chairlifts

On peut définir le confort d'usage comme la facilité d'utilisation d'un télésiège par la clientèle

We can define the comfort of use as the ease of use of a chairlift by customers



ROMA 1957
PARIS 1963
LUZERN 1969
WIEN 1975

MÜNCHEN 1981
GRENOBLE 1987
BARCELONA 1993
SAN FRANCISCO 1999

INNSBRUCK 2005
RIO DE JANEIRO 2011
BOLZANO-BOZEN 2017



SAM - SALON DE L'AMÉNAGEMENT EN MONTAGNE
INTERNATIONAL MOUNTAIN DEVELOPMENT FAIR

Gestion de l'embarquement sur les télésièges / Management of boarding on chairlifts



3.2 - Grille de notation – synthèse

Critères d'évaluation			Note	Coef.	Total
Position sur le domaine skiable et type de clientèle principale				1	
• Clientèle majoritaire					
• Proportion d'enfant de petite taille					
Aménagement de la file d'attente				1	
• Pente	Avant bornes	Entre bornes et portillon			
• Largeur	Avant bornes	Entre bornes et portillon			
• Présence de virages fermés	Avant bornes	Entre bornes et portillon			
Présence d'une zone tampon de longueur comprise entre 5 et 10 m					
Aménagement d'une file « enfants » côté surveillant O/N				1	
Aménagement entre portillon cadenceur et ligne d'embarquement				1	
• Profil en long (pente)					
• Profil en travers (vue en plan)					
• Nature du sol					
Visualisation de la ligne d'embarquement et des couloirs				1	
• Ligne d'embarquement					
• Couloirs d'embarquement					
Distance entre portillon cadenceur et ligne d'embarquement				1	
Temps laissé au client pour se préparer à embarquer				2	
• Temps moyen pour aller du portillon à la ligne d'embarquement					
Cote d'embarquement	valeur	Côte adaptée O/N		1	
Vitesse d'embarquement Uniquement pour TSF	valeur	Vit. adaptée O/N		1	
Temps libre entre sièges	valeur	Temps adapté O/N			
Type de revêtement de siège		Glissant O/N		1	
Géométrie de l'assise (inclinaison)		Favorable O/N		1	
Ø de poulie et guidage des véhicules		balancement véhicules O/N		1	
Largeur d'assise des sièges	valeur	≥ 45 cm O/N		1	
TOTAL					



ROMA 1957
PARIS 1963
LUZERN 1969
WIEN 1975

MÜNCHEN 1981
GRENOBLE 1987
BARCELONA 1993
SAN FRANCISCO 1999

INNSBRUCK 2005
RIO DE JANEIRO 2011
BOLZANO-BOZEN 2017



Staff safety and assistance are considered
an integrated transport service



ROMA 1957
PARIS 1963
LUZERN 1969
WIEN 1975

MÜNCHEN 1981
GRENOBLE 1987
BARCELONA 1993
SAN FRANCISCO 1999

INNSBRUCK 2005
RIO DE JANEIRO 2011
BOLZANO-BOZEN 2017



Gestion de l'embarquement sur les télésièges / *Management of boarding on chairlifts*

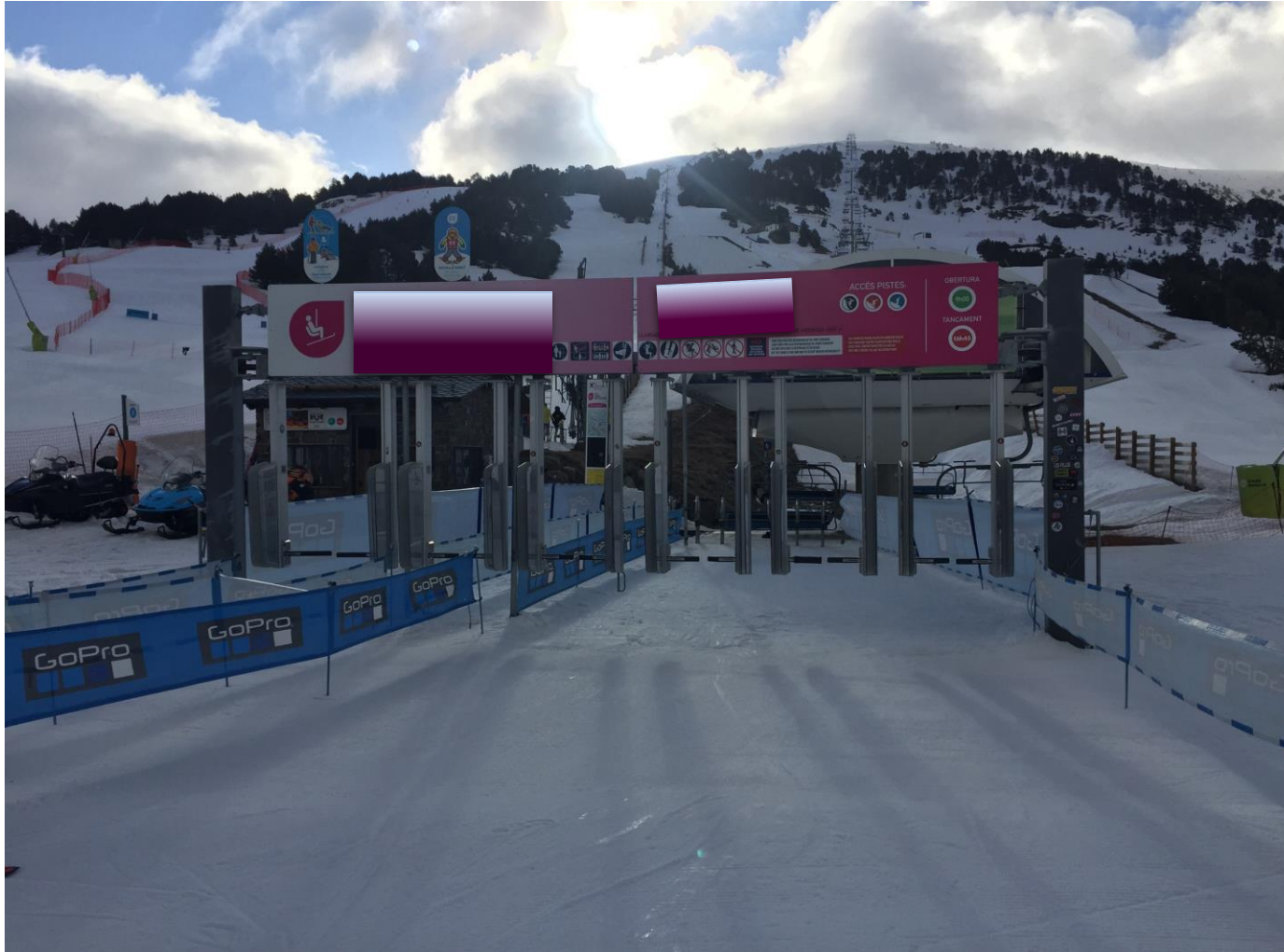



ROMA 1957
PARIS 1963
LUZERN 1969
WIEN 1975

MÜNCHEN 1981
GRENoble 1987
BARCELONA 1993
SAN FRANCISCO 1999

INNSBRUCK 2005
RIO DE JANEIRO 2011
BOLZANO-BOZEN 2017



Gestion de l'embarquement sur les télésièges / *Management of boarding on chairlifts*





ROMA 1957
PARIS 1963
LUZERN 1969
WIEN 1975

MÜNCHEN 1981
GRENoble 1987
BARCELONA 1993
SAN FRANCISCO 1999

INNSBRUCK 2005
RIO DE JANEIRO 2011
BOLZANO-BOZEN 2017



Gestion de l'embarquement sur les télésièges / *Management of boarding on chairlifts*





ROMA 1957
PARIS 1963
LUZERN 1969
WIEN 1975

MÜNCHEN1981
GRENOBLE 1987
BARCELONA 1993
SAN FRANCISCO 1999

INNSBRUCK 2005
RIO DE JANEIRO 2011
BOLZANO-BOZEN 2017



Gestion de l'embarquement sur les télésièges / *Management of boarding on chairlifts*

Activities for customers in France





ROMA 1957
PARIS 1963
LUZERN 1969
WIEN 1975

MÜNCHEN 1981
GRENOBLE 1987
BARCELONA 1993
SAN FRANCISCO 1999

INNSBRUCK 2005
RIO DE JANEIRO 2011
BOLZANO-BOZEN 2017



Gestion de l'embarquement sur les télésièges / *Management of boarding on chairlifts*



If I hurt board, I do not insist



ROMA 1957
PARIS 1963
LUZERN 1969
WIEN 1975

MÜNCHEN 1981
GRENOBLE 1987
BARCELONA 1993
SAN FRANCISCO 1999

INNSBRUCK 2005
RIO DE JANEIRO 2011
BOLZANO-BOZEN 2017



Gestion de l'embarquement sur les télésièges / *Management of boarding on chairlifts*

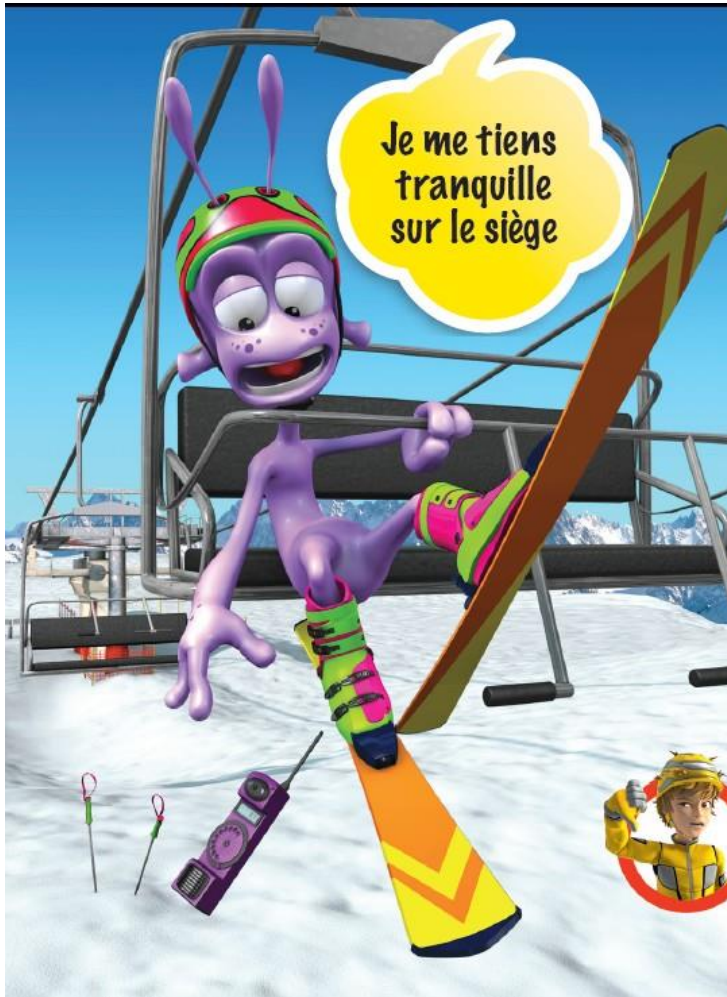

I stand still on the seat



ROMA 1957
PARIS 1963
LUZERN 1969
WIEN 1975

MÜNCHEN1981
GRENOBLE 1987
BARCELONA 1993
SAN FRANCISCO 1999

INNSBRUCK 2005
RIO DE JANEIRO 2011
BOLZANO-BOZEN 2017



Gestion de l'embarquement sur les télésièges / *Management of boarding on chairlifts*



I release the arrival quickly



ROMA 1957
PARIS 1963
LUZERN 1969
WIEN 1975

MÜNCHEN 1981
GRENOBLE 1987
BARCELONA 1993
SAN FRANCISCO 1999

INNSBRUCK 2005
RIO DE JANEIRO 2011
BOLZANO-BOZEN 2017



UTILISATION DES REMONTÉES
MECANIQUES



REGLES D'UTILISATION & BONNES PRATIQUES

**à destination des personnels
d'exploitation et des moniteurs de ski
Collaborons ensemble pour la
sécurité de nos clients**





ROMA 1957
PARIS 1963
LUZERN 1969
WIEN 1975

MÜNCHEN 1981
GRENOBLE 1987
BARCELONA 1993
SAN FRANCISCO 1999

INNSBRUCK 2005
RIO DE JANEIRO 2011
BOLZANO-BOZEN 2017



REX / Return of experience

Gestion de l'embarquement sur les téléportés & funiculaires/ *Management of boarding on cablecars & funiculars*

by E. Barbier & JC. Dupla - **M. Moyes**



ROMA 1957
PARIS 1963
LUZERN 1969
WIEN 1975

MÜNCHEN 1981
GRENOBLE 1987
BARCELONA 1993
SAN FRANCISCO 1999

INNSBRUCK 2005
RIO DE JANEIRO 2011
BOLZANO-BOZEN 2017



Gestion de l'embarquement sur télésièges / Management of boarding on chairlifts

Vision of the supervisory authority of Catalonia

- On chairlifts :
 - Anti-submarining devices
 - Fixed structures for loading and unloading areas
 - Supervisory authority inspections during operation
 - Training courses for drivers and agents
- On funiculars :
 - Platform doors

Gestion de l'embarquement sur télésièges / *Management of boarding on chairlifts*



Anti-submarining devices



Gestion de l'embarquement sur télésièges / *Management of boarding on chairlifts*

Loading areas



Gestion de l'embarquement sur télésièges / *Management of boarding on chairlifts*

Unloading areas



Gestion de l'embarquement sur télésièges / *Management of boarding on chairlifts*

Unloading areas





ROMA 1957
PARIS 1963
LUZERN 1969
WIEN 1975

MÜNCHEN 1981
GRENOBLE 1987
BARCELONA 1993
SAN FRANCISCO 1999

INNSBRUCK 2005
RIO DE JANEIRO 2011
BOLZANO-BOZEN 2017



Gestion de l'embarquement sur télésièges / *Management of boarding on chairlifts*

- Supervisory authority inspections during operation
- Training courses for drivers and agents

Gestion de l'embarquement sur télésièges / *Management of boarding on chairlifts*

On funiculars: platform doors



Gestion de l'embarquement sur télésièges / Management of boarding on chairlifts

On funiculars: platform doors

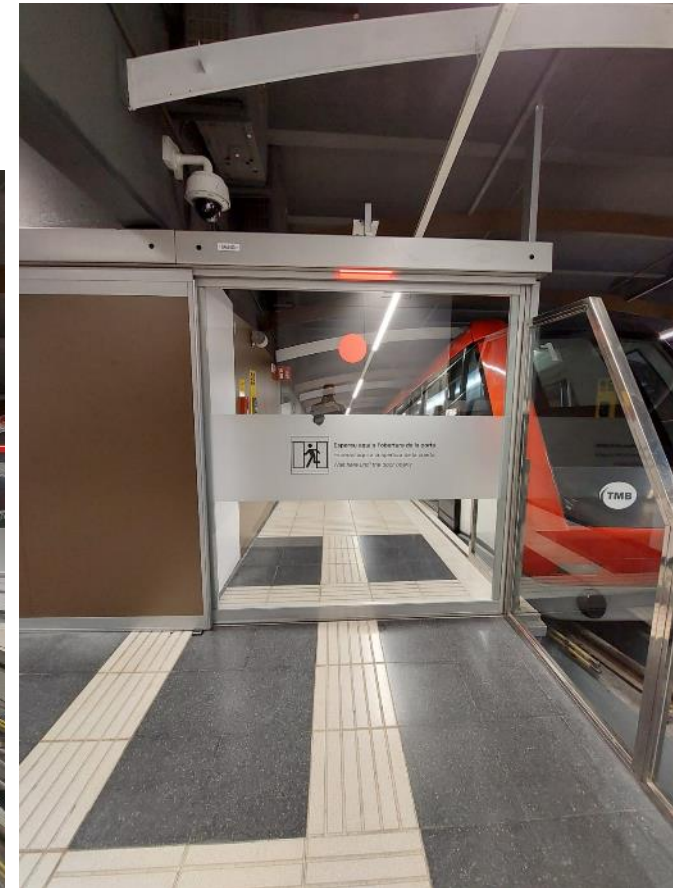
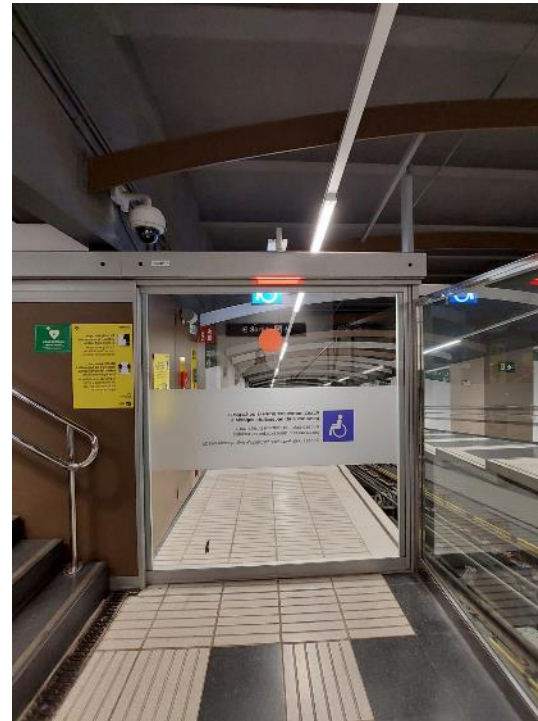



ROMA 1957
PARIS 1963
LUZERN 1969
WIEN 1975

MÜNCHEN 1981
GRENOBLE 1987
BARCELONA 1993
SAN FRANCISCO 1999

INNSBRUCK 2005
RIO DE JANEIRO 2011
BOLZANO-BOZEN 2017



REX / Return of experience

Gestion du vent / Wind management



ROMA 1957
PARIS 1963
LUZERN 1969
WIEN 1975

MÜNCHEN 1981
GRENOBLE 1987
BARCELONA 1993
SAN FRANCISCO 1999

INNSBRUCK 2005
RIO DE JANEIRO 2011
BOLZANO-BOZEN 2017



Gestion du vent / *Wind management*



Ennemi n° 1



ROMA 1957
PARIS 1963
LUZERN 1969
WIEN 1975

MÜNCHEN 1981
GRENoble 1987
BARCELONA 1993
SAN FRANCISCO 1999

INNSBRUCK 2005
RIO DE JANEIRO 2011
BOLZANO-BOZEN 2017



REX / Return of experience

Gestion du vent / *Wind management*

by **J. Sutter** - M. Walser - T. Chatelus - G. Zoppo

Gestion du vent / *Wind management*

- Manufacturer measures





ROMA 1957
PARIS 1963
LUZERN 1969
WIEN 1975

MÜNCHEN 1981
GRENOBLE 1987
BARCELONA 1993
SAN FRANCISCO 1999

INNSBRUCK 2005
RIO DE JANEIRO 2011
BOLZANO-BOZEN 2017



Gestion du vent / *Wind management*

- Planning - Requirements
- Installations for monitoring operation
- Gain and circulate experience
- Perspective of a cable car operator in Austria

Gestion du vent / *Wind management*

- Planning - Requirements
 - Experts-report wind at installation site
 - Collect experiences of nearby ropeways, ideally in the same resort and exposition

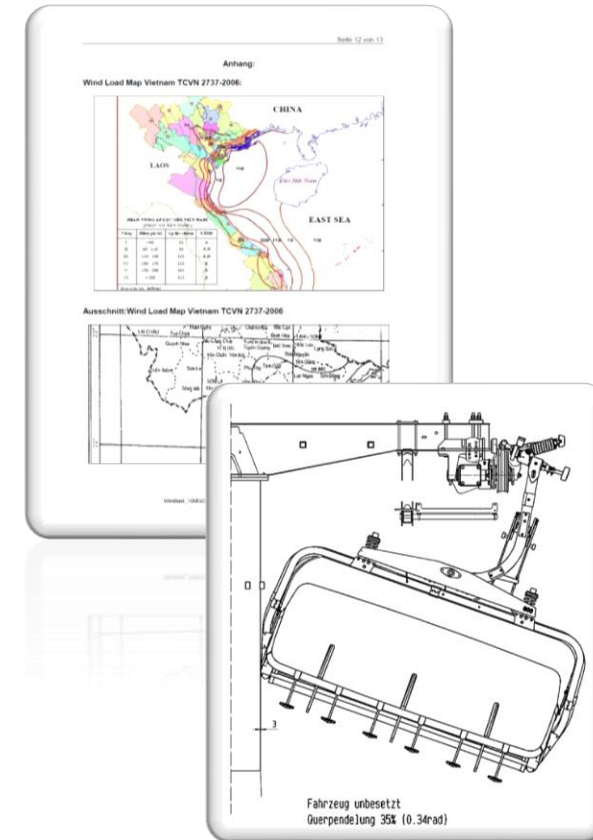

Gestion du vent / *Wind management*

- Requirements
 - Choose the appropriate ropeway system

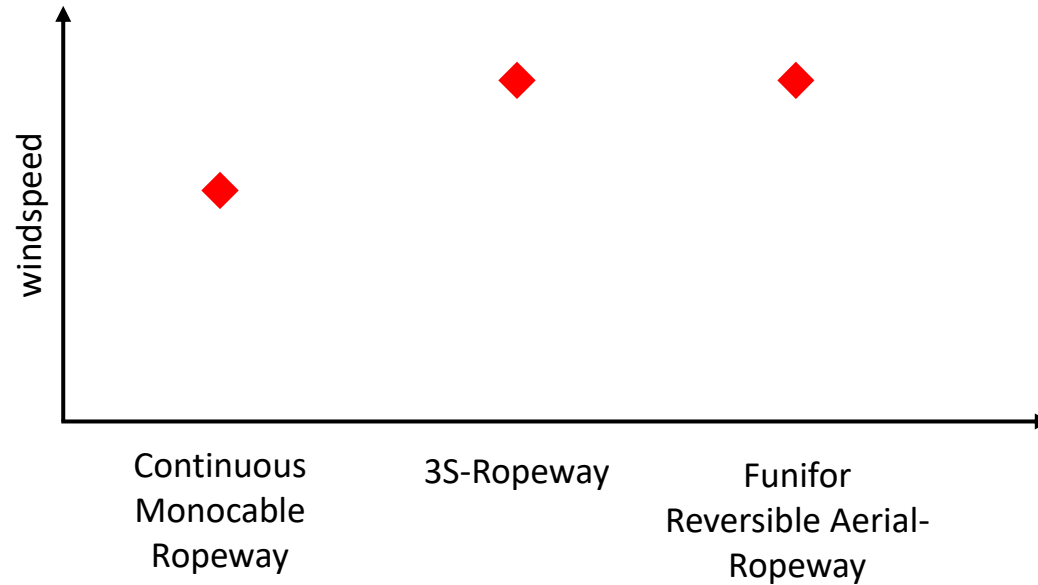

Gestion du vent / *Wind management*

- Planning – Requirements
 - Choose the appropriate location for the stations



Gestion du vent / *Wind management*

- Planning - Requirements
 - Fulfill engineering standards in case of wind actions concerning installation and sheave-assembly
 - Proof free movement between vehicle and tower
 - Guarantee a minimum of rope pressure on the sheave assemblies
 - Rope groove depth
 - Sheave flange height

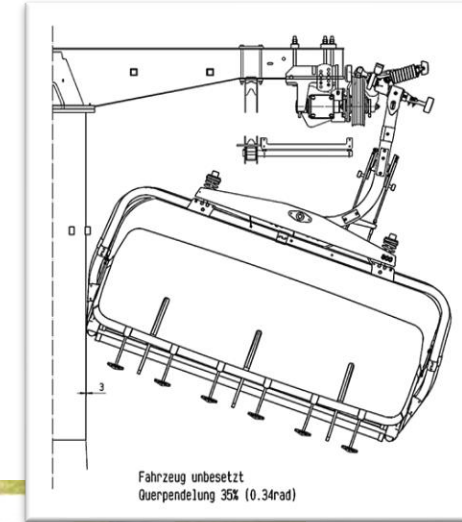

Gestion du vent / *Wind management*

- Planning - Requirements
 - Fulfill engineering standards in case of wind actions concerning installation and sheave-assembly
 - Sheave assembly with guide roller if necessary
 - Combined sheave assembly if necessary
 - etc.

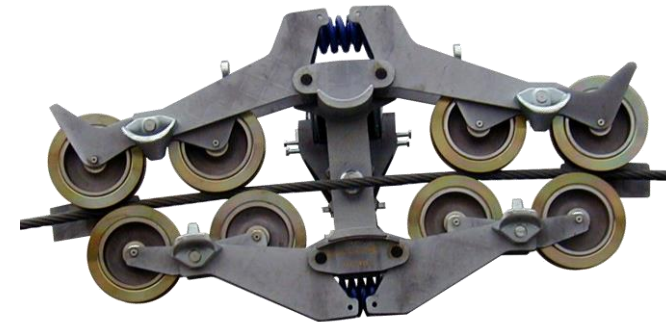
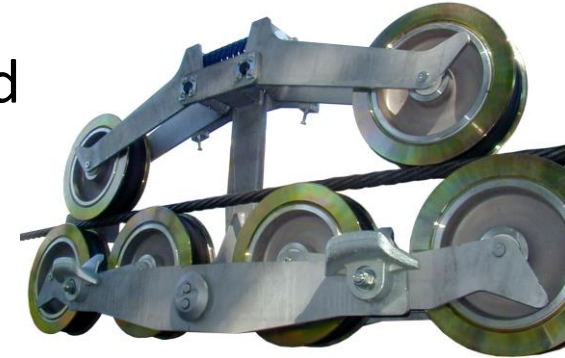

Gestion du vent / *Wind management*

- Planning – Requirements
 - Optimizing vehicle
 - Lower center of mass
 - Reduce cw-Value (wind tunnel testing)
 - Reduce area exposed to wind
 - Install oscillation damper

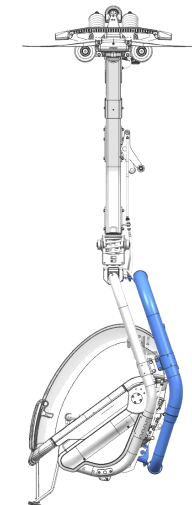

Gestion du vent / Wind management

- Planning – Requirements
 - Optimizing stations
 - Adapt unloading area depending to main wind direction



- Automated bubble closing and locking for empty chairs
- Install wind fences

Gestion du vent / *Wind management*

- Installation for monitoring the operation
 - Anemometer on exposed towers
 - Rope Positioning Detection (RPD Nexo)
 - Line cameras
- Adapted wind limits for the control system
 - Wind warnings (acoustically and visually)
 - Rope speed adapting to wind situations



Gestion du vent / *Wind management*

- Gain experience
 - Study operation manual
 - Teaching staff with general recommendations
 - Watch weather forecast
 - Observe daily operation
 - Network with nearby resorts
- Increase safety and reliability at windy condition





ROMA 1957
PARIS 1963
LUZERN 1969
WIEN 1975

MÜNCHEN 1981
GRENOBLE 1987
BARCELONA 1993
SAN FRANCISCO 1999

INNSBRUCK 2005
RIO DE JANEIRO 2011
BOLZANO-BOZEN 2017



REX / Return of experience

Gestion du vent / Wind management

by J. Sutter - **M. Walser** - T. Chatelus - G. Zoppo



ROMA 1957
PARIS 1963
LUZERN 1969
WIEN 1975

MÜNCHEN 1981
GRENOBLE 1987
BARCELONA 1993
SAN FRANCISCO 1999

INNSBRUCK 2005
RIO DE JANEIRO 2011
BOLZANO-BOZEN 2017



Gestion du vent / Wind management

Wind management for cable cars from the perspective of a cable car operator in Austria



Gestion du vent / Wind management

Operating rules for detachable monocable ropeways

Paragraph § 46 of the current draft by the supervisory authority says:

At wind speeds that cause the vehicle to swing to dangerous extent

or result in an inadmissible deflection of the carrying-hauling rope

or which cause the electrical wind warning device to respond, the following precautionary measures must be taken, **ranked by the increasing danger caused by wind:**

Gestion du vent / Wind management



Reduction of the operating speed, if this does not happen automatically



Observation of the line also with binoculars



Manning of the critical towers according to the assessment of the positional safety of the carrying-hauling rope by additional employees to check the rope guidance (except those towers that are monitored by a rope position detection system (e.g. RPD or CPS))



Recovery of the ropeway



Shut down of the ropeway

Gestion du vent / Wind management

The machine operator is in this case **not allowed** to perform the tasks and obligations of the station employee.

Note:

The station employees shall ensure the proper handling of passenger traffic. They are not allowed to leave the immediate service area while the ropeway is in motion. They shall observe the passenger loading and unloading process and shut down the ropeway, if the operating procedure is not correct.



Gestion du vent / Wind management

Daily study of the local weather forecast

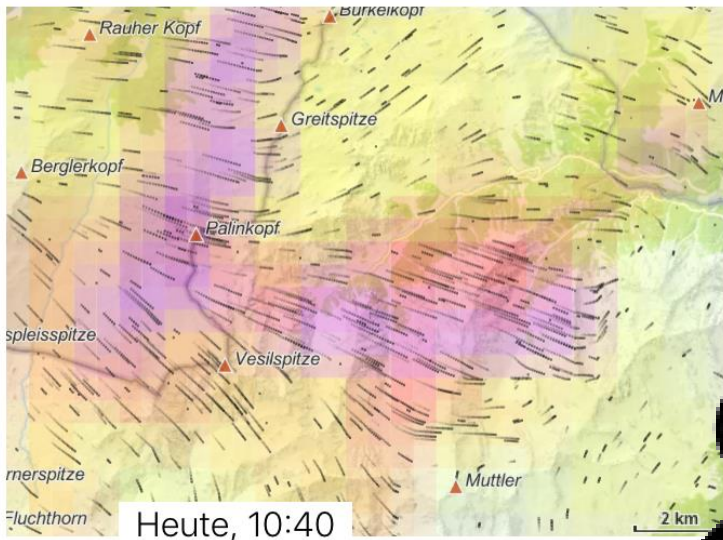

Farbskala: Beaufort

Wind

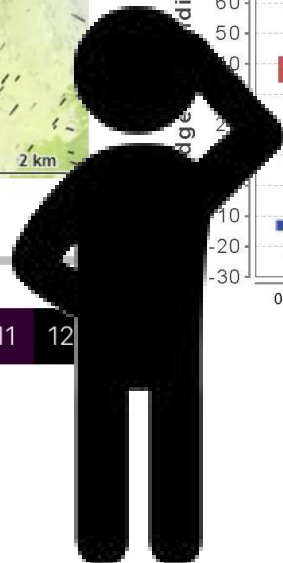

Windrichtung, Mittelwind (10-minütiger Mittelwert) und Windböen

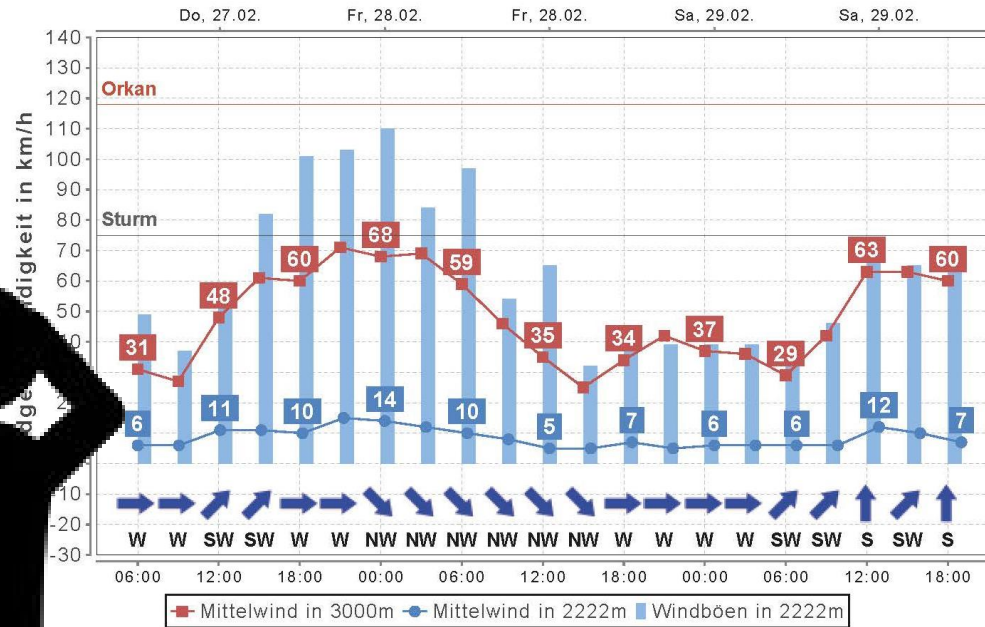



ROMA 1957
PARIS 1963
LUZERN 1969
WIEN 1975

MÜNCHEN 1981
GRENOBLE 1987
BARCELONA 1993
SAN FRANCISCO 1999

INNSBRUCK 2005
RIO DE JANEIRO 2011
BOLZANO-BOZEN 2017



REX / Return of experience

Gestion du vent / Wind management

by J. Sutter - M. Walser - **T. Chatelus** - G. Zoppo



ROMA 1957
PARIS 1963
LUZERN 1969
WIEN 1975

MÜNCHEN 1981
GRENOBLE 1987
BARCELONA 1993
SAN FRANCISCO 1999

INNSBRUCK 2005
RIO DE JANEIRO 2011
BOLZANO-BOZEN 2017



Gestion du vent / *Wind management*

- In France, some recent incidents involving vehicles and towers, in strong wind conditions
- In the same time, strong demands on high wind speed in operation
- Also, the impression strong wind gusts have become more frequent in last ~5 years



Gestion du vent / *Wind management*

- Study / Working Group on the subject managed by STRMTG, associating French ropeway professionals between 2017-2019
- Calculations > focus on most critical vehicles/ropeways for wind :
 - Detachable monocable ropeways, more specifically :

- **1) Bubble chairs**



- Other detachable ropeways allowed to operate in strong wind conditions >250 Pa ~20m/s (72 km/h)

- **2) Cabins** more critical than



- **3) Open chairs**



Gestion du vent / *Wind management*

- → Increased French rules for new « wind-critical » ropeways :
 - Specific justification on wind measurement and associated automatic actions
 - Determination of real longitudinal vehicle inclination, and ensuring associated clearance on installation with additional margin

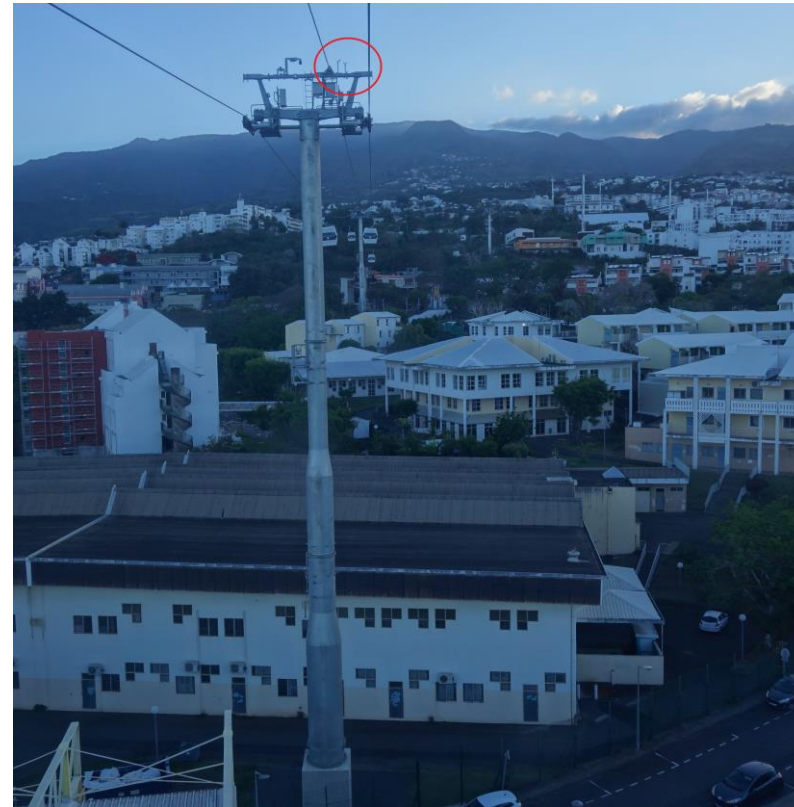



ROMA 1957
PARIS 1963
LUZERN 1969
WIEN 1975

MÜNCHEN 1981
GRENOBLE 1987
BARCELONA 1993
SAN FRANCISCO 1999

INNSBRUCK 2005
RIO DE JANEIRO 2011
BOLZANO-BOZEN 2017



Gestion du vent / *Wind management*

- → Actions on existing « wind-critical » detachable ropeways (bubbles and/or >250Pa)
 - Measures on wind management, vehicle oscillations / clearance profiles
 - Graduated measures depending on vehicle types / criticality
 - Approach spread over 5 years (15-20 ropeways / year), in decreasing criticality order

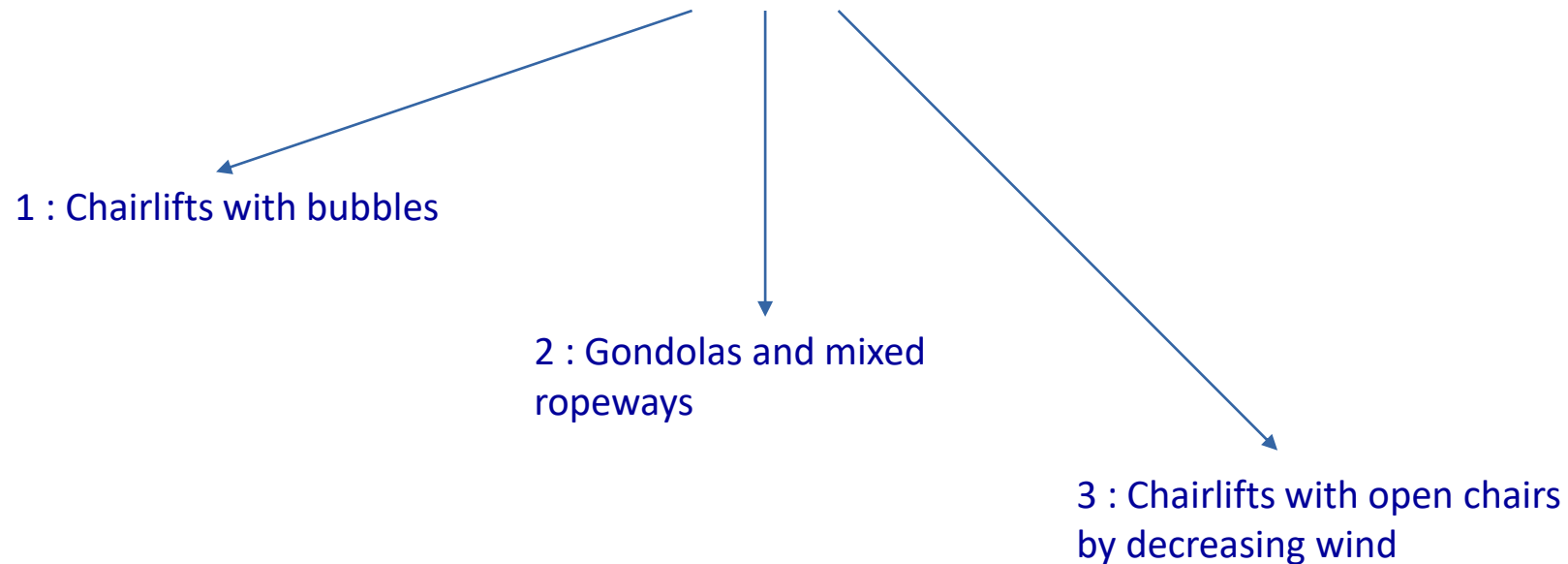



ROMA 1957
PARIS 1963
LUZERN 1969
WIEN 1975

MÜNCHEN 1981
GRENOBLE 1987
BARCELONA 1993
SAN FRANCISCO 1999

INNSBRUCK 2005
RIO DE JANEIRO 2011
BOLZANO-BOZEN 2017



Gestion du vent / *Wind management*

- Common will to discuss the subject on international level to share experiences
- Need for a common direction, not being blinded by the nearest wind gusts





ROMA 1957
PARIS 1963
LUZERN 1969
WIEN 1975

MÜNCHEN 1981
GRENOBLE 1987
BARCELONA 1993
SAN FRANCISCO 1999

INNSBRUCK 2005
RIO DE JANEIRO 2011
BOLZANO-BOZEN 2017



REX / Return of experience

Gestion du vent / Wind management

by J. Sutter - M. Walser - T. Chatelus - **G. Zoppo**



ROMA 1957
PARIS 1963
LUZERN 1969
WIEN 1975

MÜNCHEN 1981
GRENOBLE 1987
BARCELONA 1993
SAN FRANCISCO 1999

INNSBRUCK 2005
RIO DE JANEIRO 2011
BOLZANO-BOZEN 2017



Gestion du vent / *Wind management*

SLOWDOWN SPEED





ROMA 1957
PARIS 1963
LUZERN 1969
WIEN 1975

MÜNCHEN 1981
GRENoble 1987
BARCELONA 1993
SAN FRANCISCO 1999

INNSBRUCK 2005
RIO DE JANEIRO 2011
BOLZANO-BOZEN 2017



Gestion du vent / *Wind management*

TREE FALLING PROJECT



Gestion du vent / *Wind management*

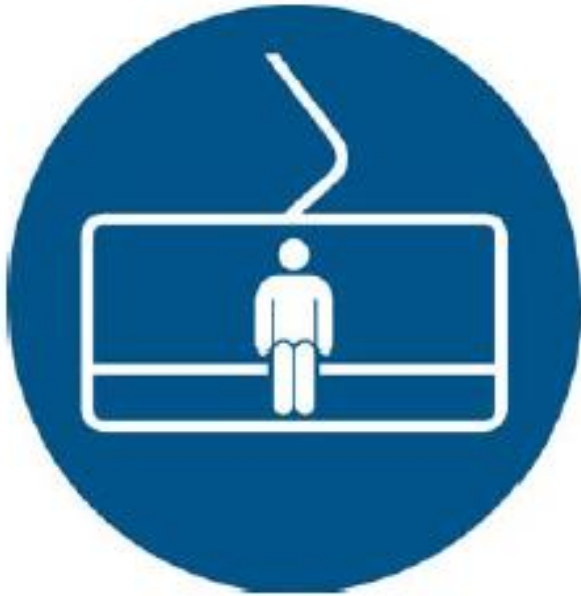



ROMA 1957
PARIS 1963
LUZERN 1969
WIEN 1975

MÜNCHEN 1981
GRENOBLE 1987
BARCELONA 1993
SAN FRANCISCO 1999

INNSBRUCK 2005
RIO DE JANEIRO 2011
BOLZANO-BOZEN 2017



Gestion du vent / *Wind management*





ROMA 1957
PARIS 1963
LUZERN 1969
WIEN 1975

MÜNCHEN 1981
GRENOBLE 1987
BARCELONA 1993
SAN FRANCISCO 1999

INNSBRUCK 2005
RIO DE JANEIRO 2011
BOLZANO-BOZEN 2017



Organisation des secours / *Rescue organization*

by **M. Joyeusaz**



ROMA 1957
PARIS 1963
LUZERN 1969
WIEN 1975

MÜNCHEN 1981
GRENOBLE 1987
BARCELONA 1993
SAN FRANCISCO 1999

INNSBRUCK 2005
RIO DE JANEIRO 2011
BOLZANO-BOZEN 2017



Organisation des secours / Rescue organization



CERVINO – MATTERHORN

SKI PARADISE





ROMA 1957
PARIS 1963
LUZERN 1969
WIEN 1975

MÜNCHEN 1981
GRENOBLE 1987
BARCELONA 1993
SAN FRANCISCO 1999

INNSBRUCK 2005
RIO DE JANEIRO 2011
BOLZANO-BOZEN 2017



Organisation des secours / *Rescue organization*



CERVINO – MATTERHORN

SKI PARADISE



Organisation des secours / Rescue organization



CERVINO – MATTERHORN

SKI PARADISE



- **64 ropeways**
- **102.830 p/h**
- **> 25.000.000 passages/year**
- **3.235.000 presences**
- **392 km ski slopes**
- **115 mil € turnover**
- **655 employees**

Organisation des secours / *Rescue organization*



- **130 qualified rescuers for cableways**
- **136 qualified rescuers for ski slopes**
- **14 first aid stations**
- **6 ambulance helicopters**
- **4 equipped private ambulances**
- **25 snowmobiles for rescue**
- **58 toboggans**
- **17 defibrillators**
- **98 avalanche rescue equipments (probe, shovel, transceiver)**
- **~2.000/year rescues carried out**
- **32,5 min average rescue time**



ROMA 1957
PARIS 1963
LUZERN 1969
WIEN 1975

MÜNCHEN 1981
GRENOBLE 1987
BARCELONA 1993
SAN FRANCISCO 1999

INNSBRUCK 2005
RIO DE JANEIRO 2011
BOLZANO-BOZEN 2017



Organisation des secours / *Rescue organization*



BREUIL – CERVINIA

Evacuation of 12/24/2016



ROMA 1957
PARIS 1963
LUZERN 1969
WIEN 1975

MÜNCHEN 1981
GRENoble 1987
BARCELONA 1993
SAN FRANCISCO 1999

INNSBRUCK 2005
RIO DE JANEIRO 2011
BOLZANO-BOZEN 2017



Organisation des secours / *Rescue organization*



CERVINO – MATTERHORN

SKI PARADISE



Organisation des secours / *Rescue organization*



Gondola KC16 Plan Maison – Laghi C.B. (2536-2814)

Length	2.278 m
Vertical drop	278 m
Hourly flow	2.400 p/h
Vehicle capacity	12 pers
Online vehicles	25 x 2
Wind threshold 1 (slowdown)	60 km/h
Wind threshold 2 (stop)	70 km/h

Organisation des secours / Rescue organization



CERVINO – MATTERHORN

SKI PARADISE

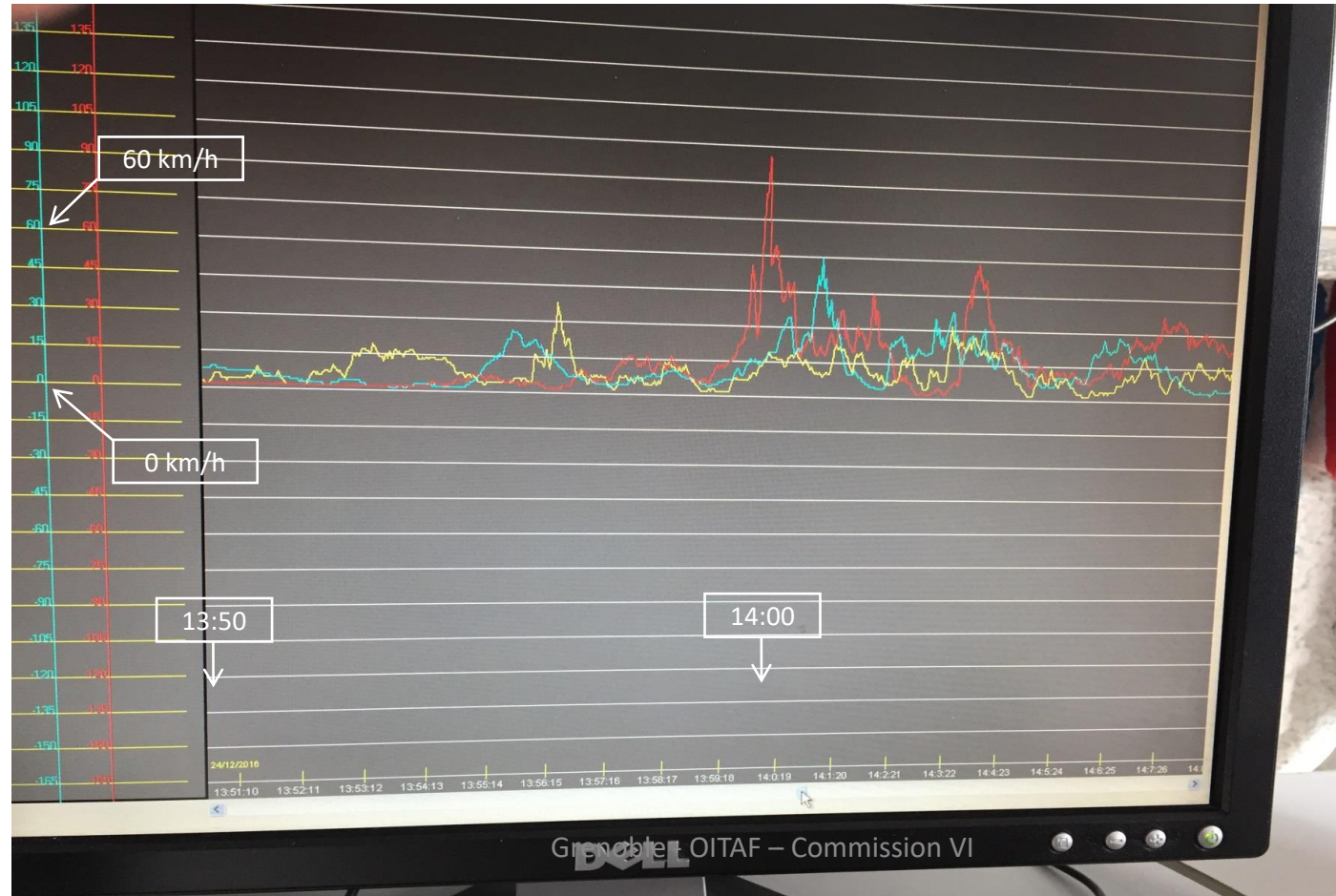



ROMA 1957
PARIS 1963
LUZERN 1969
WIEN 1975

MÜNCHEN 1981
GRENOBLE 1987
BARCELONA 1993
SAN FRANCISCO 1999

INNSBRUCK 2005
RIO DE JANEIRO 2011
BOLZANO-BOZEN 2017



Organisation des secours / Rescue organization



CERVINO – MATTERHORN

SKI PARADISE

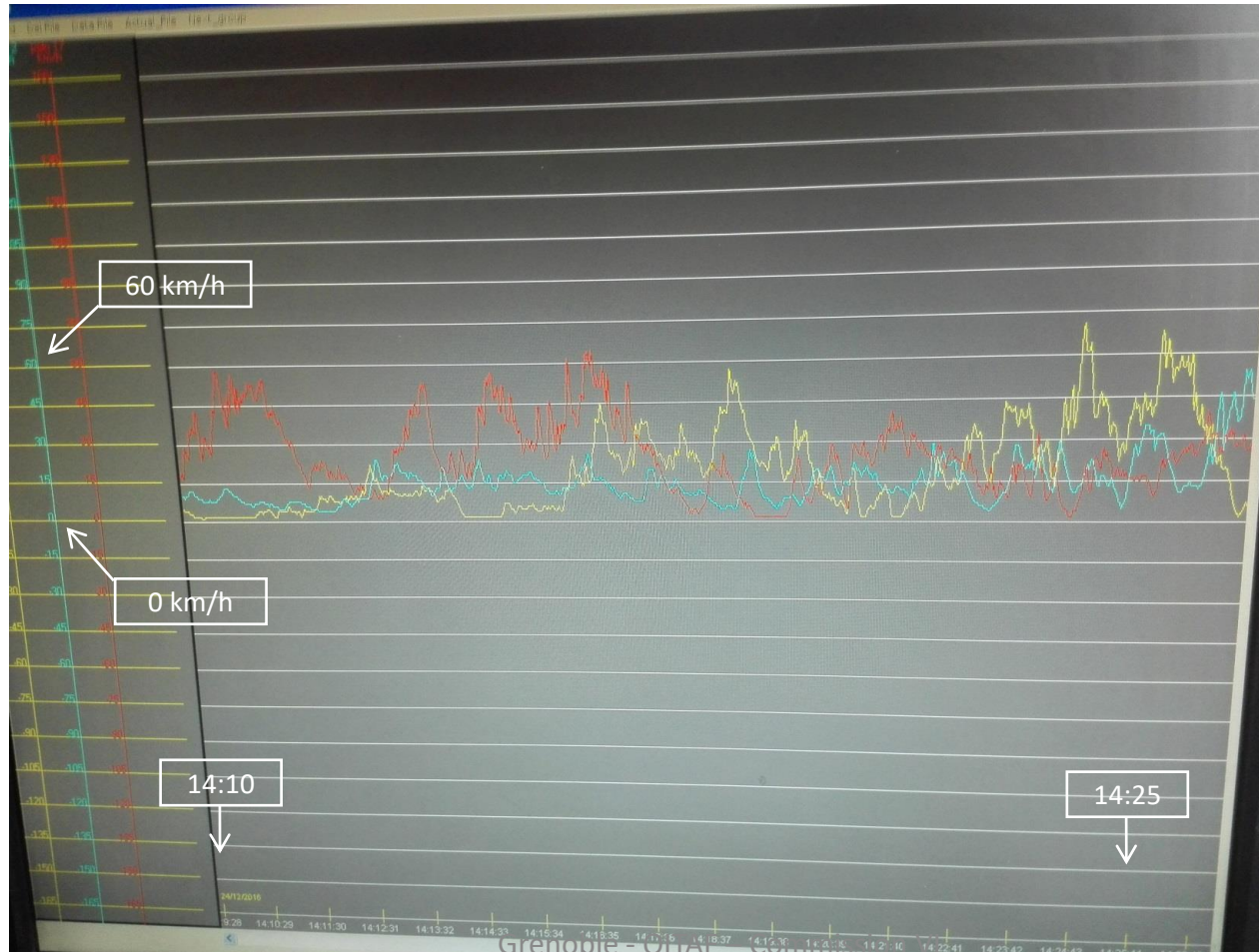



ROMA 1957
PARIS 1963
LUZERN 1969
WIEN 1975

MÜNCHEN 1981
GRENOBLE 1987
BARCELONA 1993
SAN FRANCISCO 1999

INNSBRUCK 2005
RIO DE JANEIRO 2011
BOLZANO-BOZEN 2017



Organisation des secours / Rescue organization



CERVINO – MATTERHORN

SKI PARADISE

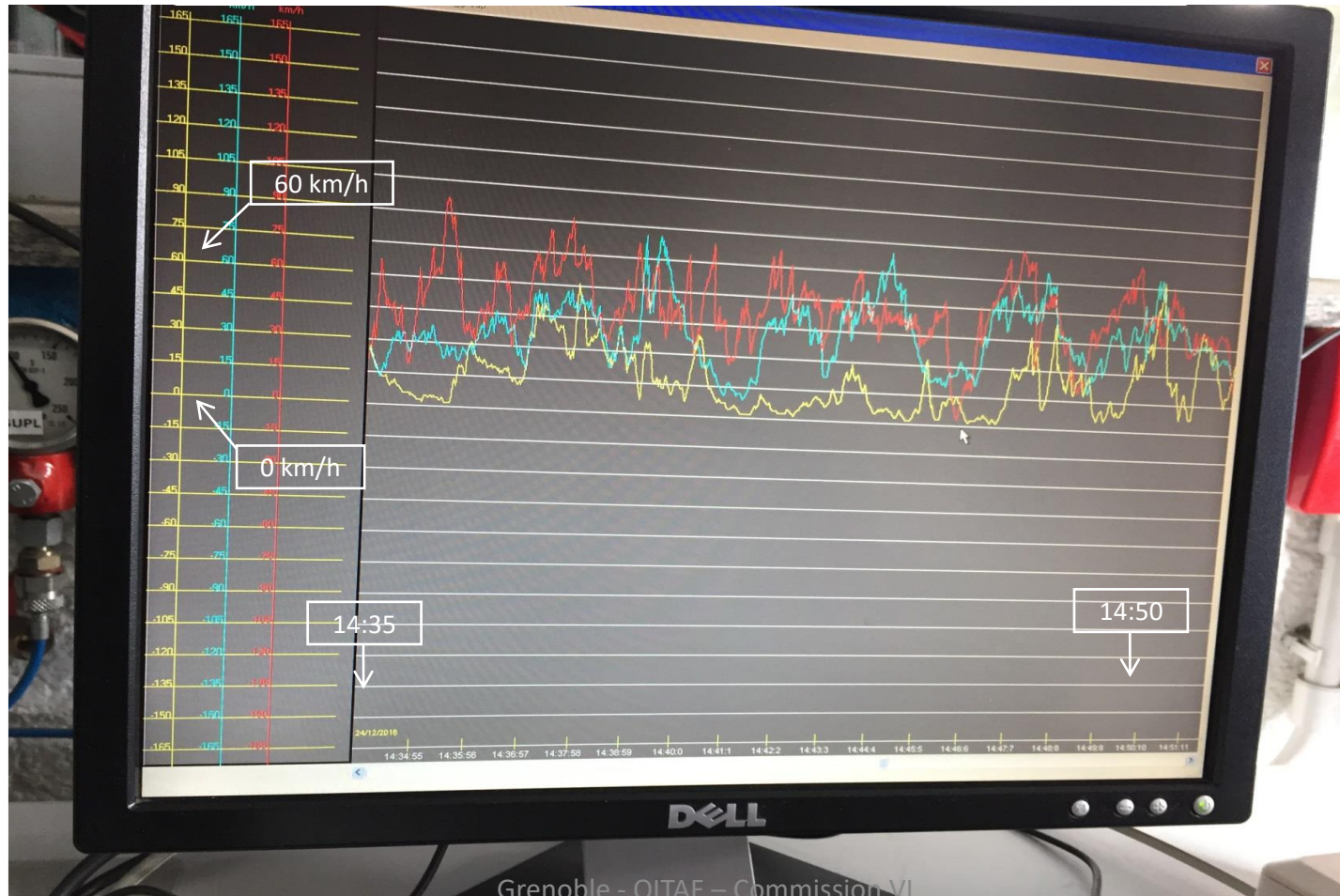



ROMA 1957
PARIS 1963
LUZERN 1969
WIEN 1975

MÜNCHEN 1981
GRENOBLE 1987
BARCELONA 1993
SAN FRANCISCO 1999

INNSBRUCK 2005
RIO DE JANEIRO 2011
BOLZANO-BOZEN 2017



Organisation des secours / Rescue organization



CERVINO – MATTERHORN

SKI PARADISE

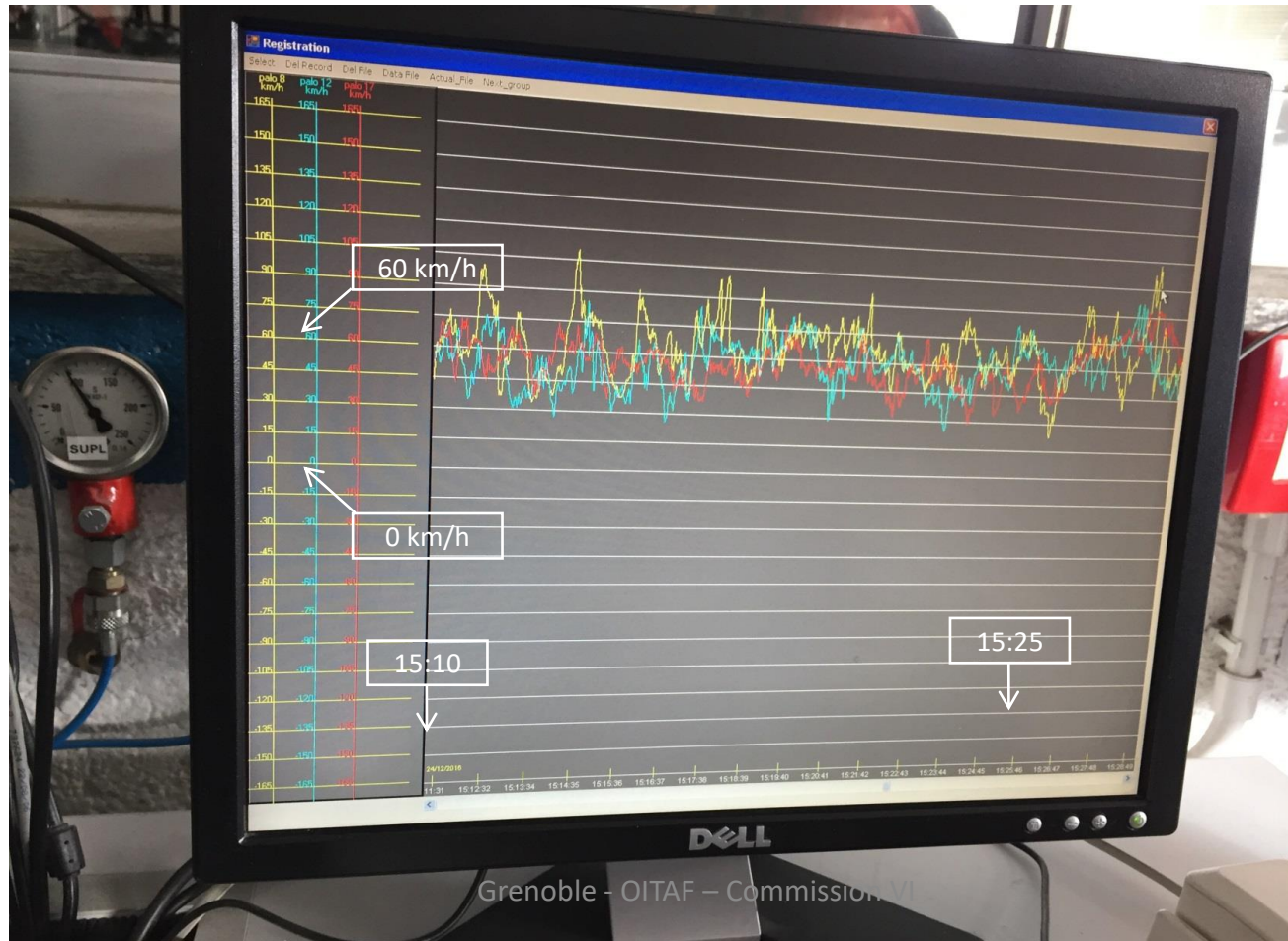



ROMA 1957
PARIS 1963
LUZERN 1969
WIEN 1975

MÜNCHEN 1981
GRENOBLE 1987
BARCELONA 1993
SAN FRANCISCO 1999

INNSBRUCK 2005
RIO DE JANEIRO 2011
BOLZANO-BOZEN 2017



Organisation des secours / Rescue organization



CERVINO – MATTERHORN

SKI PARADISE

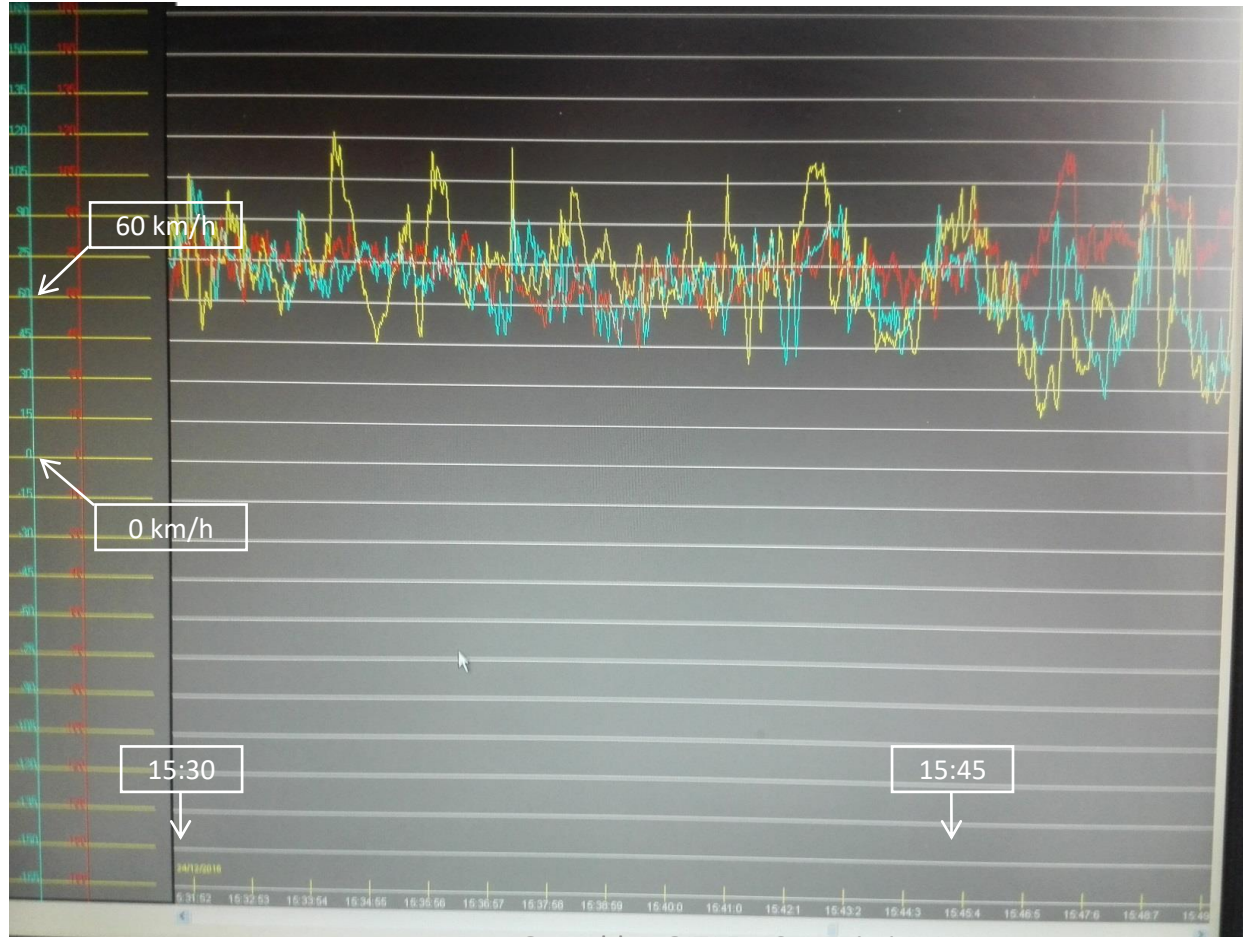



ROMA 1957
PARIS 1963
LUZERN 1969
WIEN 1975

MÜNCHEN 1981
GRENoble 1987
BARCELONA 1993
SAN FRANCISCO 1999

INNSBRUCK 2005
RIO DE JANEIRO 2011
BOLZANO-BOZEN 2017



Organisation des secours / *Rescue organization*



CERVINO – MATTERHORN
SKI PARADISE





ROMA 1957
PARIS 1963
LUZERN 1969
WIEN 1975

MÜNCHEN 1981
GRENOBLE 1987
BARCELONA 1993
SAN FRANCISCO 1999

INNSBRUCK 2005
RIO DE JANEIRO 2011
BOLZANO-BOZEN 2017



Organisation des secours / Rescue organization



Organisation des secours / Rescue organization



Favorable conditions

- mild temperature (slightly below 0°)
- closed vehicles

Adverse conditions

- impetuous wind (no helicopter, strong obstacle to operations)
- eminent night (ephemeris 16,40 h)
- 2 lines loaded with 140 passengers on board
- no ski slope under the lift
- some sections of the line not accessible by means of transport or skis

Organisation des secours / Rescue organization



Operators

- **12 evacuation teams for a total of 50 rescuers (SAV, GdF, Alpine guides of Cervinia and Zermatt, Cervino S.p.A.)**
- **Volunteers of 118 (3 doctors + 2 psychologists for emergencies), Forestry, Fire Brigade**
- **Law enforcement (Carabinieri, Polizia)**
- **Municipality of Valtournenche**
- **Employees of 2 refreshment points (comfort items)**
- **Cervino S.p.A. employees**

Organisation des secours / *Rescue organization*



Means / equipment used

- **3 helicopters**
- **13 snow grooming machines**
- **10 snowmobiles**
- **rescue equipment (supplied with the ropeways)**
- **light projectors**
- **medical devices**

Organisation des secours / Rescue organization



Result

ALL PASSENGERS EVACUATED AND UNHARMED

Actions taken

- **Conversion from stop to slowdown due to wind limit**
- **Line configuration improvement**
- **New lifelines and improvement access paths below the line**
- **Equipment with new portable electric projectors**
- **Battery-operated fronts and multiple radio charging devices**
- **Vehicle bottom numbering**
- **Adoption of devices for autonomous movement along the rope and for elevation from the ground**



ROMA 1957
PARIS 1963
LUZERN 1969
WIEN 1975

MÜNCHEN 1981
GRENoble 1987
BARCELONA 1993
SAN FRANCISCO 1999

INNSBRUCK 2005
RIO DE JANEIRO 2011
BOLZANO-BOZEN 2017



Organisation des secours / Rescue organization



CERVINO – MATTERHORN

SKI PARADISE





ROMA 1957
PARIS 1963
LUZERN 1969
WIEN 1975

MÜNCHEN 1981
GRENOBLE 1987
BARCELONA 1993
SAN FRANCISCO 1999

INNSBRUCK 2005
RIO DE JANEIRO 2011
BOLZANO-BOZEN 2017



Statistiques / *Statistics*

by **T. Chatelus** - G. Schöber



ROMA 1957

PARIS 1963

LUZERN 1969

WIEN 1975

MÜNCHEN 1981

GRENOBLE 1987

BARCELONA 1993

SAN FRANCISCO 1999

INNSBRUCK 2005

RIO DE JANEIRO 2011

BOLZANO-BOZEN 2017



Casualty Statistics for France - Introduction

- Numbers must be handled with care, even with stabilized « official » data, as declaration modalities may still vary from one transport mode to another
- Sources :
 - French Ministry for Transports – transport key figures 2019, 2020 and 2021 (data until 2019)
 - STRMTG yearly accident reports for tramways, underground railways and ropeways between 2012 and 2019 (reliable data for all systems)
 - 2020 data available, but ski resorts were closed in France during season 2020-2021
- « Serious victim » = seriously injured or deceased person

Casualty Statistics for France

- **Raw number of serious victims**

min/max per Year

- Road :



22853-31180

- Maritime :



956-1487

- Air :



83-130

- Main railway



92-157

- Underground railways :

477-581

- Tramway :



36-70

- Ropeways :



28-42

- But these systems do not carry same amount of passengers & do not travel the same distance
> necessity of ratios for better (not perfect !) comparison

Casualty Statistics for France

- **Order of magnitude for ratio serious victims / million passengers :**

➤ Road :		> 100
➤ Maritime :		30
➤ Air :		3
➤ Main railway		0,1
Underground railways :		0,2
➤ Tramway :		< 0,1
➤ Ropeways :		< 0,1

This choice of ratio is always questionable, but this is the only ratio with official traffic data available for all systems

Casualty Statistics for France

- **On ropeways, most common type of accidents :**
 - ~ 70 % of accidents on chairlifts, mainly with fixed grips
 - 2/3 of accidents linked to passenger behaviour, mainly awkwardness leading to a fall

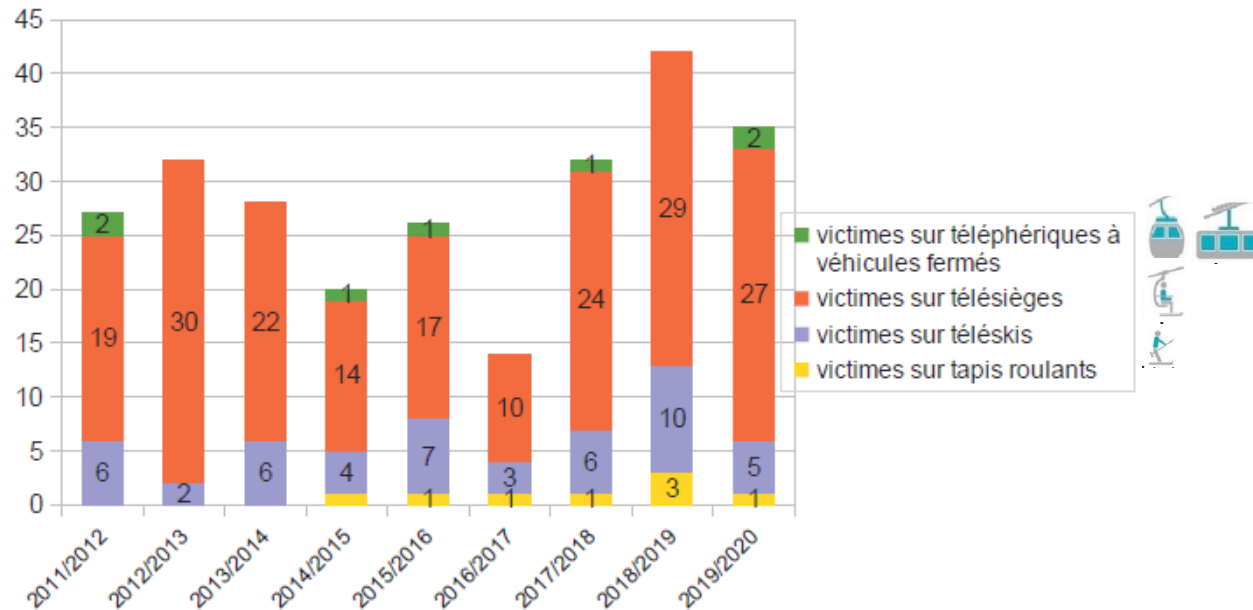



ROMA 1957
PARIS 1963
LUZERN 1969
WIEN 1975

MÜNCHEN 1981
GRENOBLE 1987
BARCELONA 1993
SAN FRANCISCO 1999

INNSBRUCK 2005
RIO DE JANEIRO 2011
BOLZANO-BOZEN 2017



Statistiques / *Statistics*

by T. Chatelus - **G. Schober**



ROMA 1957
PARIS 1963
LUZERN 1969
WIEN 1975

MÜNCHEN 1981
GRENOBLE 1987
BARCELONA 1993
SAN FRANCISCO 1999

INNSBRUCK 2005
RIO DE JANEIRO 2011
BOLZANO-BOZEN 2017



Statistiques/ Statistics

Risk and Safety of Ropeway Systems

Dr. Georg Schober
TÜV SÜD Industrie Service GmbH

Statistiques/ Statistics

ITTAB Statistics

8 Ropeway Categories

Incidences, Fatalities, Injuries

4 main causes

Countries with continuous statistics

Reversible Aerial Tramway
Chair Lift
Chair Lift detachable
Chair Lift fixed
Gondola Lift
Gondola Lift detachable
Gondola Lift fixed
Funicular
Surface Lift

External Influence
Technical Failure
Passenger
Staff

Percentage distribution of installed ropeways (2020)

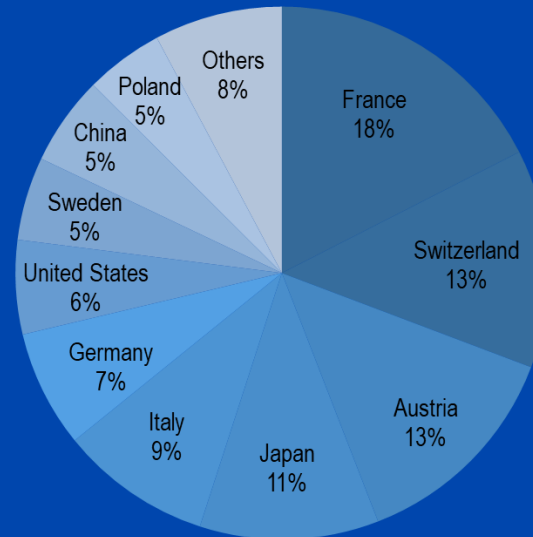

Statistiques/ *Statistics*

Standard Risk Values – used in public transport systems



Fatalities
or incidents
per
100 million
person travel
hours

Statistiques/ Statistics

How safe are ropeway systems?

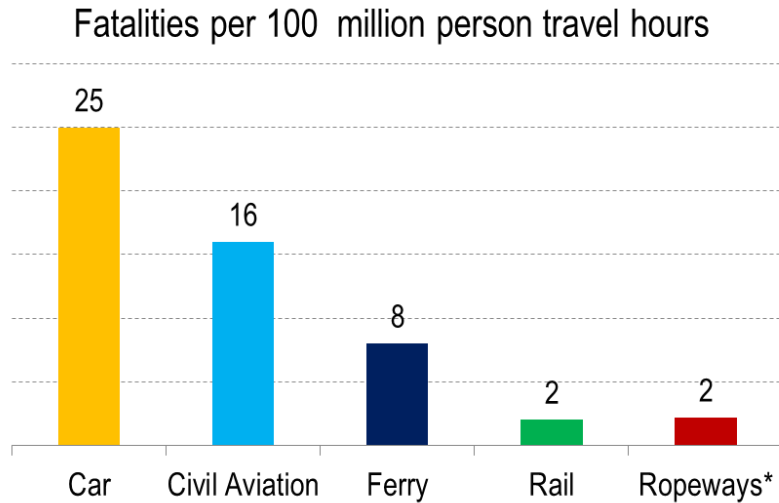

Values from other modes of transport out of:
TRANSPORT SAFETY PERFORMANCE IN THE EU A STATISTICAL OVERVIEW;
ISBN: 90-76024-154

Safest way to travel

*If you assume an average travel time of 6 minutes and a utilization of 50%

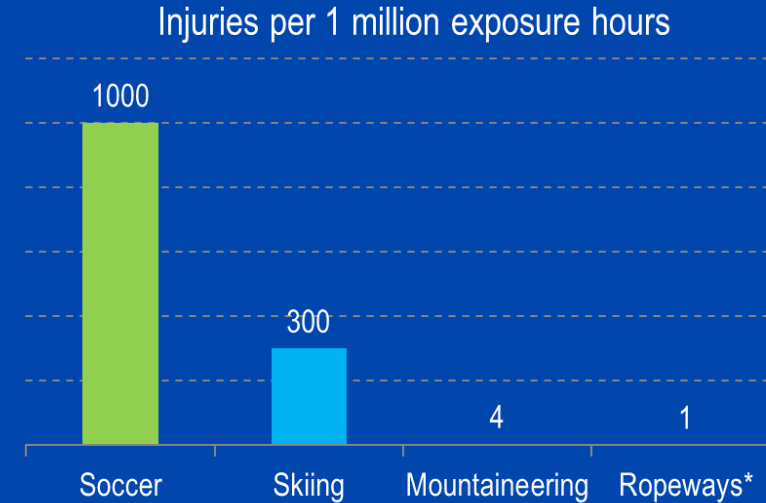

+ risk of injury is negligible in comparison with alpine sports

Statistiques/ Statistics

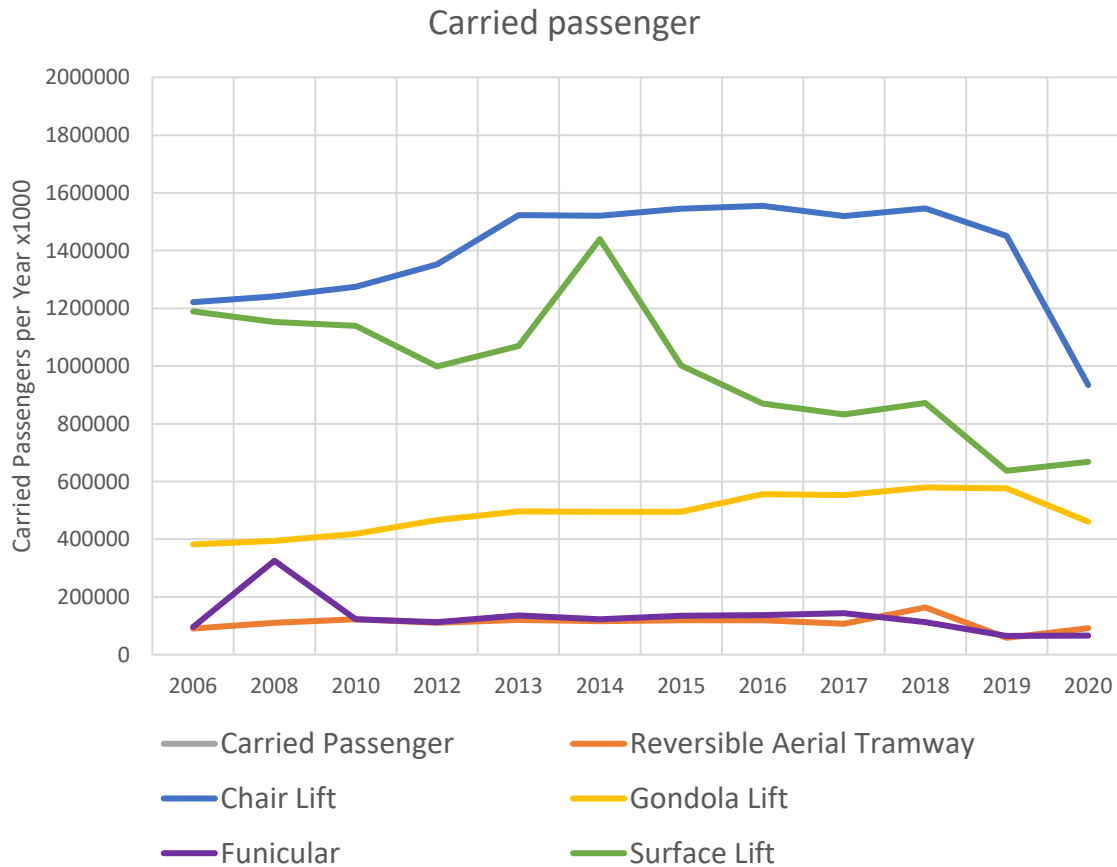

- Urban ropeways in Latin America are not within this statistic
- Uncertainties regarding the capacities of skilifts (surface lifts)

Statistiques/ Statistics

Have ropeways become safer?

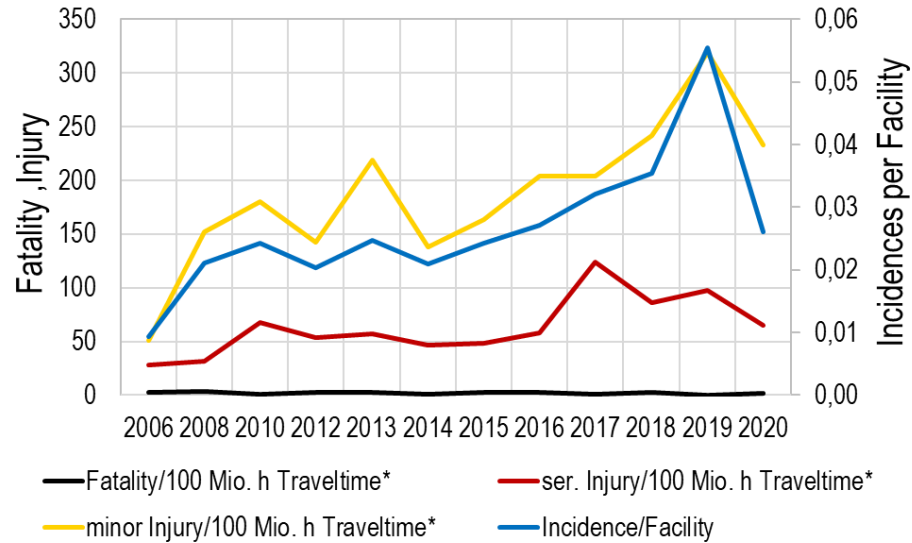

no relevant change

*If you assume an average travel time of 6 minutes and a utilization of 50%

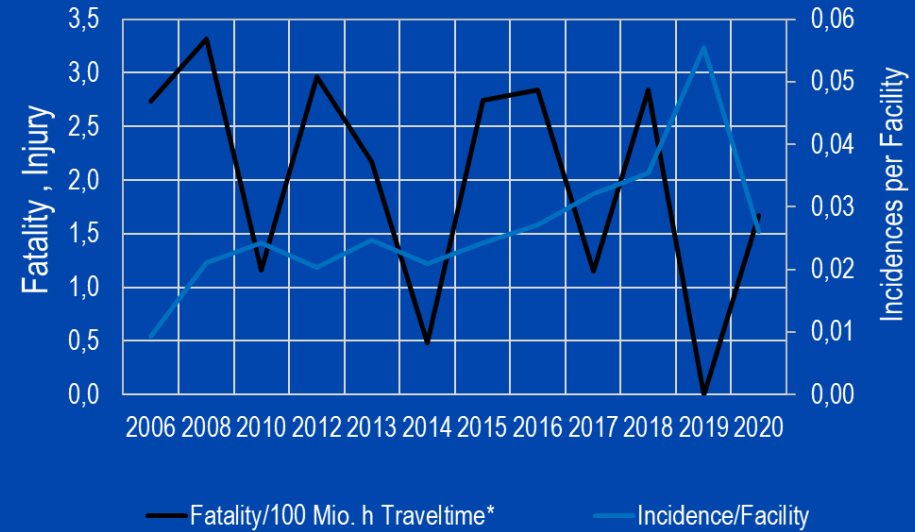

+ more incidences find their way into statistic

Statistiques/ Statistics

Average values of 2006 - 2020

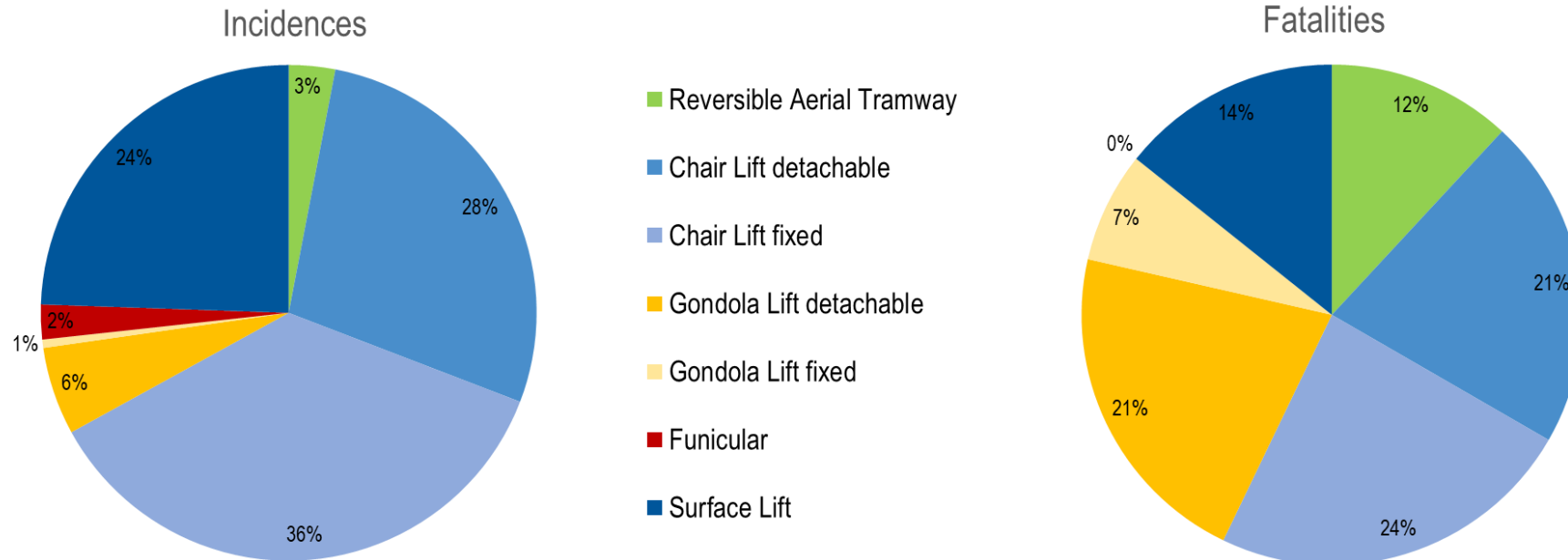

Gondola lifts and reversible aerial tramways have a disproportional fatality rate

Statistiques/ Statistics

Average values of 2006 - 2020

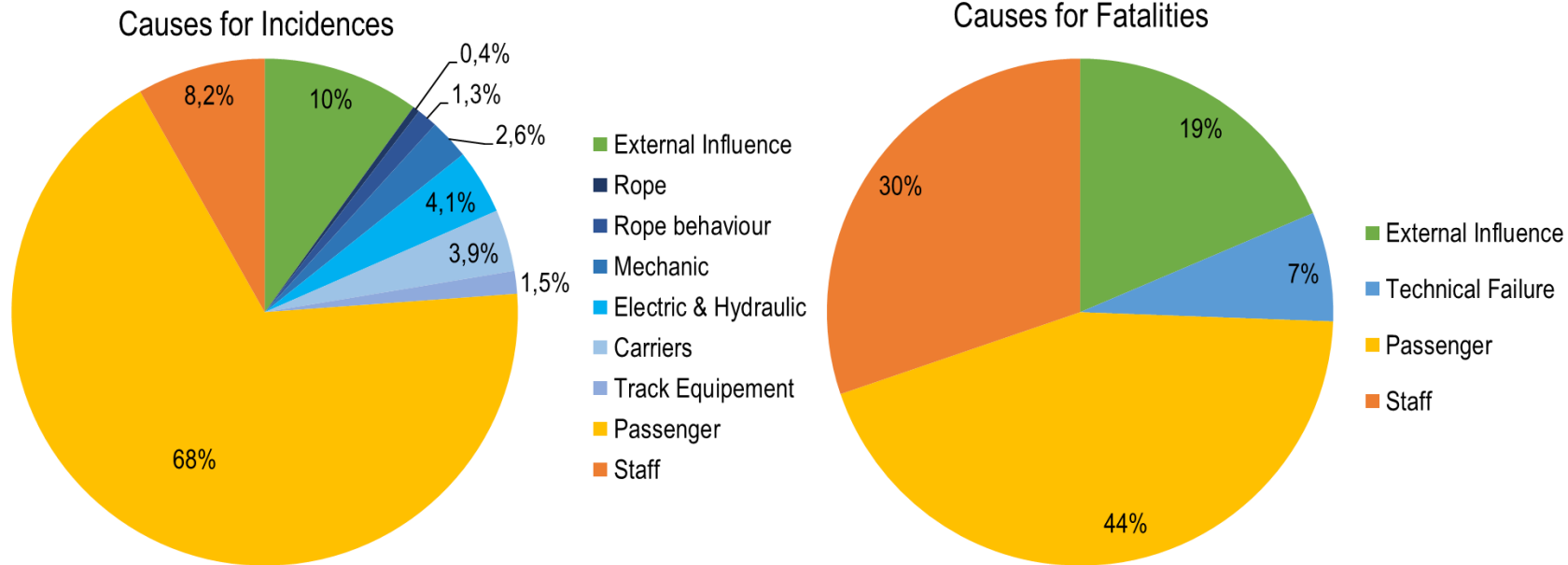

Technical causes have a minor influence on the fatality rate



ROMA 1957
PARIS 1963
LUZERN 1969
WIEN 1975

MÜNCHEN 1981
GRENOBLE 1987
BARCELONA 1993
SAN FRANCISCO 1999

INNSBRUCK 2005
RIO DE JANEIRO 2011
BOLZANO-BOZEN 2017



Statistiques/ *Statistics*

Conclusion

- + due to very “public publishing”, statistic become more accurate
- + fatality and injury rates are stable over the last 10 years
- + technical failure is the rarest cause for fatality

- + gondola lifts and RAT have the lowest incidence rate
- + Qualification of the ropeway staff is an essential task
- + Longterm experience & development by manufacturers, operators, control- & inspection bodies ensure relevant safety



ROMA 1957
 PARIS 1963
 LUZERN 1969
 WIEN 1975

MÜNCHEN 1981
 GRENOBLE 1987
 BARCELONA 1993
 SAN FRANCISCO 1999

INNSBRUCK 2005
 RIO DE JANEIRO 2011
 BOLZANO-BOZEN 2017



Thank you for your attention!



www.tuvsud.com ropeways@tuvsud.com



ROMA 1957
PARIS 1963
LUZERN 1969
WIEN 1975

MÜNCHEN 1981
GRENOBLE 1987
BARCELONA 1993
SAN FRANCISCO 1999

INNSBRUCK 2005
RIO DE JANEIRO 2011
BOLZANO-BOZEN 2017



Q & A



ROMA 1957
PARIS 1963
LUZERN 1969
WIEN 1975

MÜNCHEN 1981
GRENOBLE 1987
BARCELONA 1993
SAN FRANCISCO 1999

INNSBRUCK 2005
RIO DE JANEIRO 2011
BOLZANO-BOZEN 2017



Intervenants /Speakers:

-  • **Enric Barbier** **Operator**, Technical Manager, Grandvalira - Ensisa , (AND)
-  • **Alex Barès** **Operator**, General Manager, Baqueira Beret, (ESP)
-  • **Olivier Bertolami** **Manufacturer**, Industrial Director, GMM (FR)
-  • **Thibault Chatelus** **Supervisory Authority**, STRM-TG, (FR)
-  • **Richard Dietsch** **Control Organism**, TUV, (D)
-  • **Jean Claude Dupla** **Operator**, Tech. Manager, Altiservice, (FR)
-  • **Fabrice Estieu** **Operator**, Tech. Manager, Lift company, Megève, (FR)
-  • **Mauro Joyeusaz** **Operator**, Technical Manager Cervino, Pres. Com.VI OITAF (IT)
-  • **Miriam Moyes** **Supervisory Authority**, Generalitat de Catalunya, (ESP)
-  • **Nicolas Perretta** **Operator**, General Manager, Queyras, (FR)
-  • **Georg Schober** **Control Organism**, TUV, (D)
-  • **Josef Sutter** **Manufacturer**, Technical Manager, Doppelmayr, (AT)
-  • **Markus Walser** **Operator**, General Manager, Silvretta Bergbahnen, (AT)
-  • **Marc Ziegler** **Operator**, Training Center Manager of RMS, (CH)
-  • **Giuliano Zoppo** **Supervisory Authority**, SIF, Aosta Valley, (IT)



ROMA 1957
PARIS 1963
LUZERN 1969
WIEN 1975

MÜNCHEN 1981
GRENOBLE 1987
BARCELONA 1993
SAN FRANCISCO 1999

INNSBRUCK 2005
RIO DE JANEIRO 2011
BOLZANO-BOZEN 2017



Cableways: top level of safety!





ROMA 1957
PARIS 1963
LUZERN 1969
WIEN 1975

MÜNCHEN 1981
GRENOBLE 1987
BARCELONA 1993
SAN FRANCISCO 1999

INNSBRUCK 2005
RIO DE JANEIRO 2011
BOLZANO-BOZEN 2017

