



➤ Auswirkungen des Seilbahnverordnung-entwurfs und der Seilbahnnormen CEN



➤ The new harmonized standard series:
Modifications and other important aspects



- Überarbeitung
Seilbahnrichtlinie /
Revision of
Cableway Directive
- Überarbeitung harmonisierte
Normenreihe /
Revision of harmonized
standards

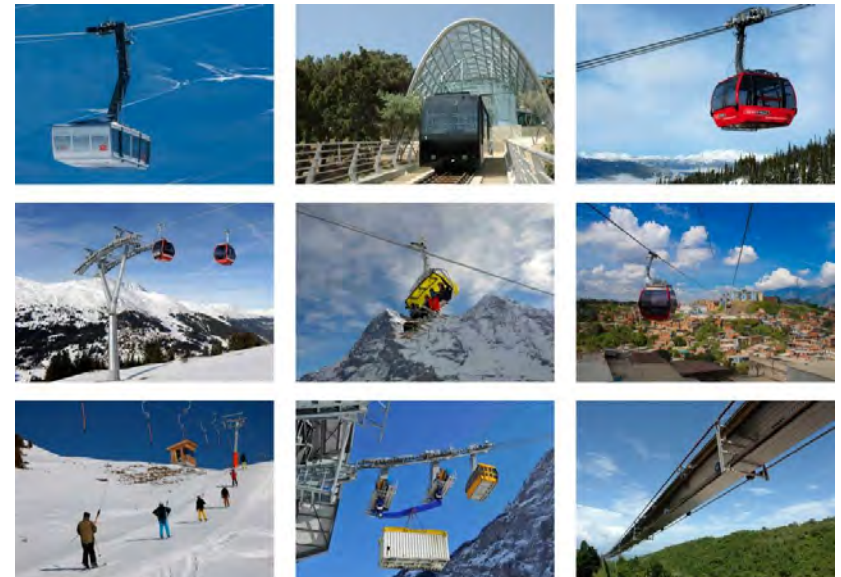



↗ Überarbeitung Seilbahnrichtlinie / Revision of cableway Directive

Verordnungsentwurf auf Europäischer Ebene, Stand März `15 /
Draft for European regulation, date March `15



- ↗ Richtlinie 2000/9/EG wird überarbeitet
- ↗ Wird zukünftig eine Verordnung werden
- ↗ (rein theoretisch) keine länderspezifischen Gesetze mehr

- ↗ Directive 2000/9/EC will be changed
- ↗ Will be a regulation
- ↗ (theoretically) no national laws anymore



SEILBAHN = ANLAGE = GESAMTSYSTEM

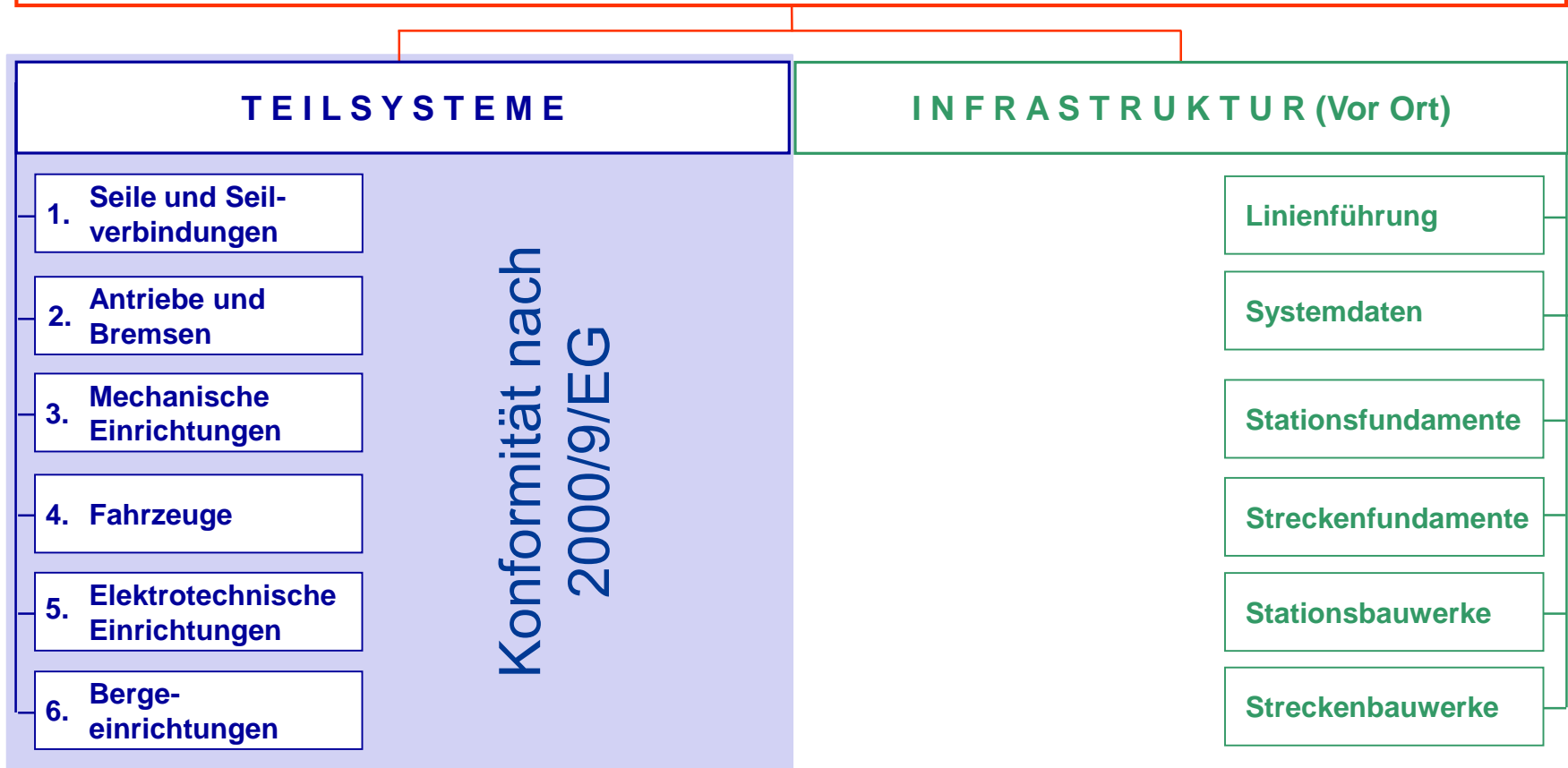



Überarbeitung Seilbahnrichtlinie / Revision of cableway Directive

SEILBAHN = ANLAGE = GESAMTSYSTEM

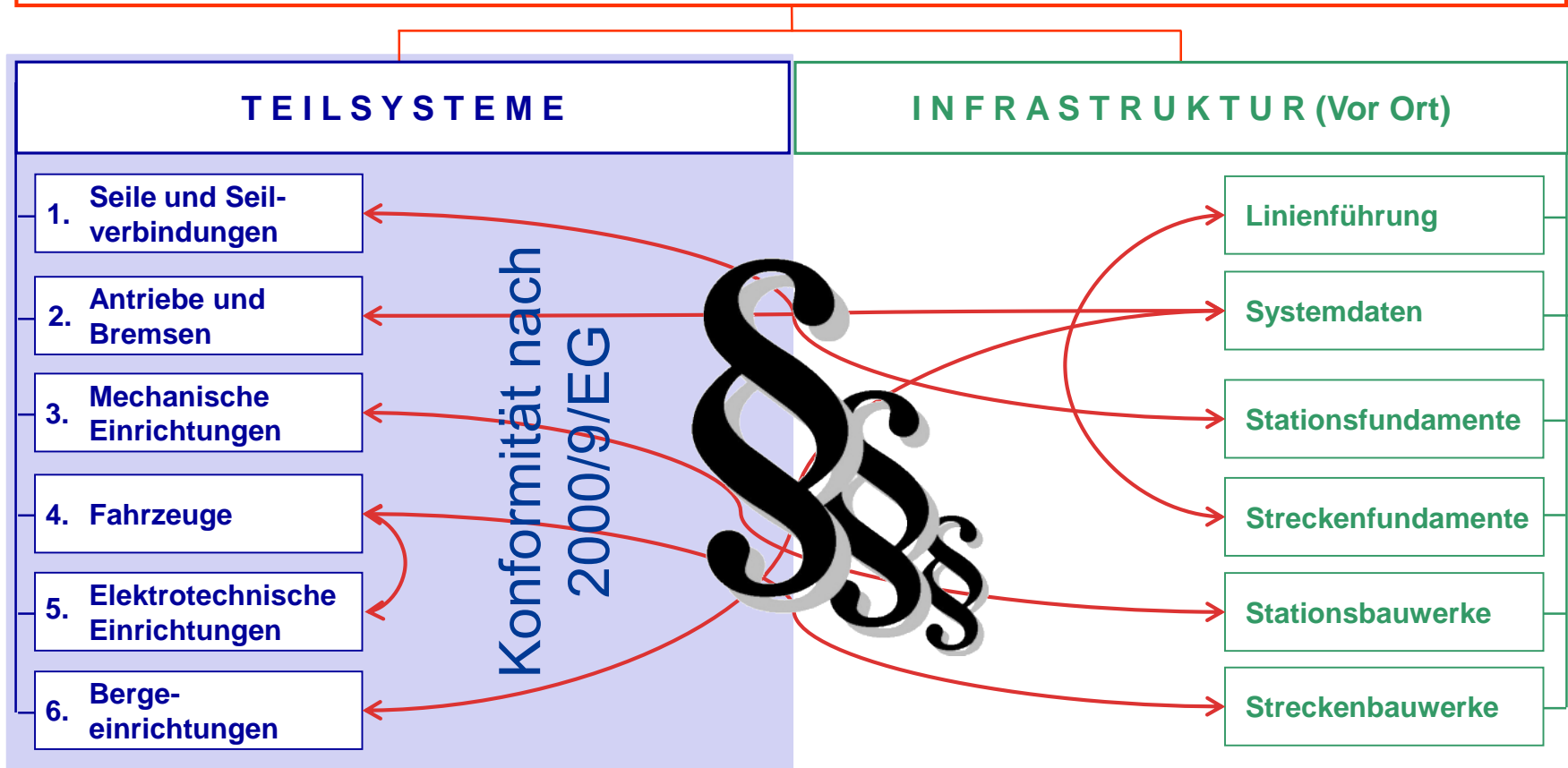



Überarbeitung Seilbahnrichtlinie / Revision of cableway Directive

➤ Wesentliche Änderungen / Major modifications

Thema / title	Beschreibung / description	Behörde / Authority	Betreiber / Operator	Benannte Stelle / Notified Body	Hersteller / Manufacturer
Art. 2, Geltungsbereich	... gilt nicht für ... als Seilbahnen historischer Bauart eingestufte Seilbahnen...	X	X	X	X
	... gilt nicht für Anlagen für den Betrieb von Berghütten, die nur für Beförderung...eigens benannten Personen bestimmt sind	X	X	X	X
Art. 2, Scope	... shall not apply to ... cableway installations categorised ... as of historical construction	X	X	X	X
	... shall not apply to ... installations for the service of mountain shelters and huts intended only for the transport of ... specifically designated persons	X	X	X	X



Überarbeitung Seilbahnrichtlinie / Revision of cableway Directive

➤ Wesentliche Änderungen / Major modifications

Thema / title	Beschreibung / description	Behörde / Authority	Betreiber / Operator	Benannte Stelle / Notified Body	Hersteller / Manufacturer
Art. 9, Genehmigung	Behörde benötigt Sicherheitsbericht, EU-Konformitätserklärung, sonstigen Unterlagen im Zusammenhang mit Konformität, Unterlagen über Seilbahnmerkmale, ... → Sicherheitsanalyse ist nicht mehr Bestandteil der Genehmigung		X		(X)
Art. 9, Authorisation	Authority gets safety report, EU declaration of conformity, other documents relating to the conformity, documentation concerning the characteristics of the cableway installation, ... → Safety analysis is not part of the authorisation anymore		X		(X)



Überarbeitung Seilbahnrichtlinie / Revision of cableway Directive

➤ Wesentliche Änderungen / Major modifications

Thema / title	Beschreibung / description	Behörde / Authority	Betreiber / Operator	Benannte Stelle / Notified Body	Hersteller / Manufacturer
div. Art., Markt- überwach ung	(Überzogene) Anforderungen an Marktüberwachung Problem: Umfangreiche Genehmigungsverfahren für Betriebsbewilligung werden hier nicht berücksichtigt	X	X	X	X
div. art., Market surveillan ce	(Excessive) requirements for market surveillance Problem: extensive authorisation process for operating permission is not considered in these requirements	X	X	X	X

Achtung!

**Das Stehenbleiben
unter der Seilbahn
ist lebensgefährlich.**



Überarbeitung Seilbahnrichtlinie / Revision of cableway Directive

➤ Wesentliche Änderungen / Major modifications

Thema / title	Beschreibung / description	Behörde / Authority	Betreiber / Operator	Benannte Stelle / Notified Body	Hersteller / Manufacturer
Art. 43, Inkrafttreten und Geltungs beginn	Verordnung gilt 2 Jahre nach Inkrafttreten Mit Notifizierungsprozess kann nach 6 Monaten nach Inkrafttreten begonnen werden Problem: Konformitätsbewertungen können mitunter nicht rechtzeitig abgeschlossen werden	X	X	X	X
Art. 43, Entry into force and date of applicatio n	Regulation shall apply from two years after entry into force With notification process can be started after 6 months after entry into force Problem: assessment of conformity might not be finished	X	X	X	X



Überarbeitung Seilbahnrichtlinie / Revision of cableway Directive



➤ Keine Berücksichtigung von:

- Aussage bezüglich Handhabung bestehender Anlagen
- Wiederaufstellungen / Versetzen von Anlagen
- Handhabung Ersatzteile
 - **Problematik v.a. bei Anlagen nach RL2000/9/EG!!!**
- ...

➤ No consideration of:

- Statement on existing installations
- Relocation of existing ropeway installations
- Handling of spare parts
 - **Problems especially regarding installations covered by Dir2000/9/EC**
- ...



Überarbeitung Seilbahnrichtlinie / Revision of cableway Directive



Ersatzteil /
spare part



Charakter: Zahl: 16603/2015

LIST OF BODIES NOTIFIED UNDER DIRECTIVE : 2000/9/EC Cableway installations designed to carry persons

Name and address of notified bodies	Identification number	Responsible for the following products	Responsible for the following products	Annexes or articles of the directives
INSTITUTO DE SOLDADURA E QUALIDADE Av. José Di Castro Silva, nº333 Taguspark Center 5746 - 120 Porto Portugal	0028	Cableway installations designed to carry persons - Subsystems	Examination for assessment of conformity of subsystems	Annex VII
TUV AUSTRIA SERVICE GmbH, vom Österreichischen Bundesministerium für Wirtschaft und Arbeit anerkannt, TÜV-Technik- und Zertifikatsorganisation TUV AUSTRIA SERVICE GmbH, Prüfung, Inspektion und Zertifizierung accredited by the Austrian Federal Ministry for Economy and Labour				Module B Module F Module G Module H
TUV SÜD Institut Wendendstraße 1 80886 München Germany				Module B Module F Module G Module H
TUV Thüringen e. Meichendorfer Str.				Module B Module F Module G Module H

~~Zertifikat - Certificate
Nr.: TÜV-A-MHF/BBT-11115-14100-E02
EG-Entwurfsprüfbescheinigung
gemäß Richtlinie 2000/9/EG (Seilbahn)
Certificate of
according to the Direct~~

~~CE-03-0408~~

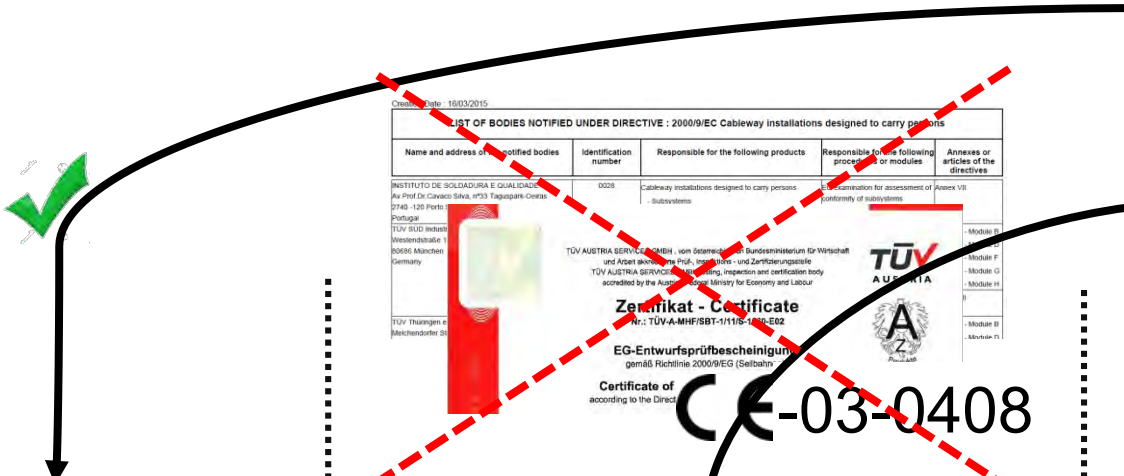

Nationale Bestimmungen



Richtlinie 2000/9/EG

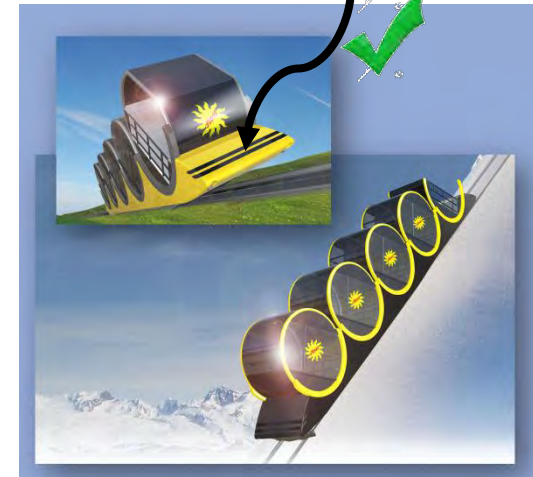

Verordnung Seilbahn

2004

ca. 2018

Zeit

«STILLSTAND IST RÜCKSCHRITT»
(Rudolf von Bennigsen-Foerder)



➤ Überarbeitung harmonisierte Normenreihe / harmonized standards

➤ Grund für die Überarbeitung von Normen

- Korrektur von offensichtlichen Fehlern in den alten Normen
- Erfahrungen, Erkenntnisse
- Stand der Technik – Entwicklungen, neue Produkte
- spezielle Interessen

➤ Reason for revision of the standards

- Correction of obvious mistakes in the old standards
- Experience, findings
- State of the art – developments, new products
- Special interests





Überarbeitung harmonisierte Normenreihe / Revision of harmonized standard



- **Zusammensetzung und Interesse der Teilnehmer der Arbeitsgruppen**
 - Behörden → neue Vorschriften, Verschärfungen, Sicherheitsdenken
 - Hersteller / andere Experten → Technische Änderungen, Erleichterungen
 - Betreiber / Fachverbände → Erleichterungen bzgl. Betrieb und Wartung

- **Composition and interest of the members of the workgroups**
 - Authorities → new regulations, tightening, safety approach
 - Manufacturers / other experts → technical changes, simplifications
 - Operators → facilitation of operation and maintenance



FprEN12929-1 Allgemeine Bestimmungen / general requirements





FprEN12929-1, 6.3.2 Feldlängenreduktion / Reduction of span length

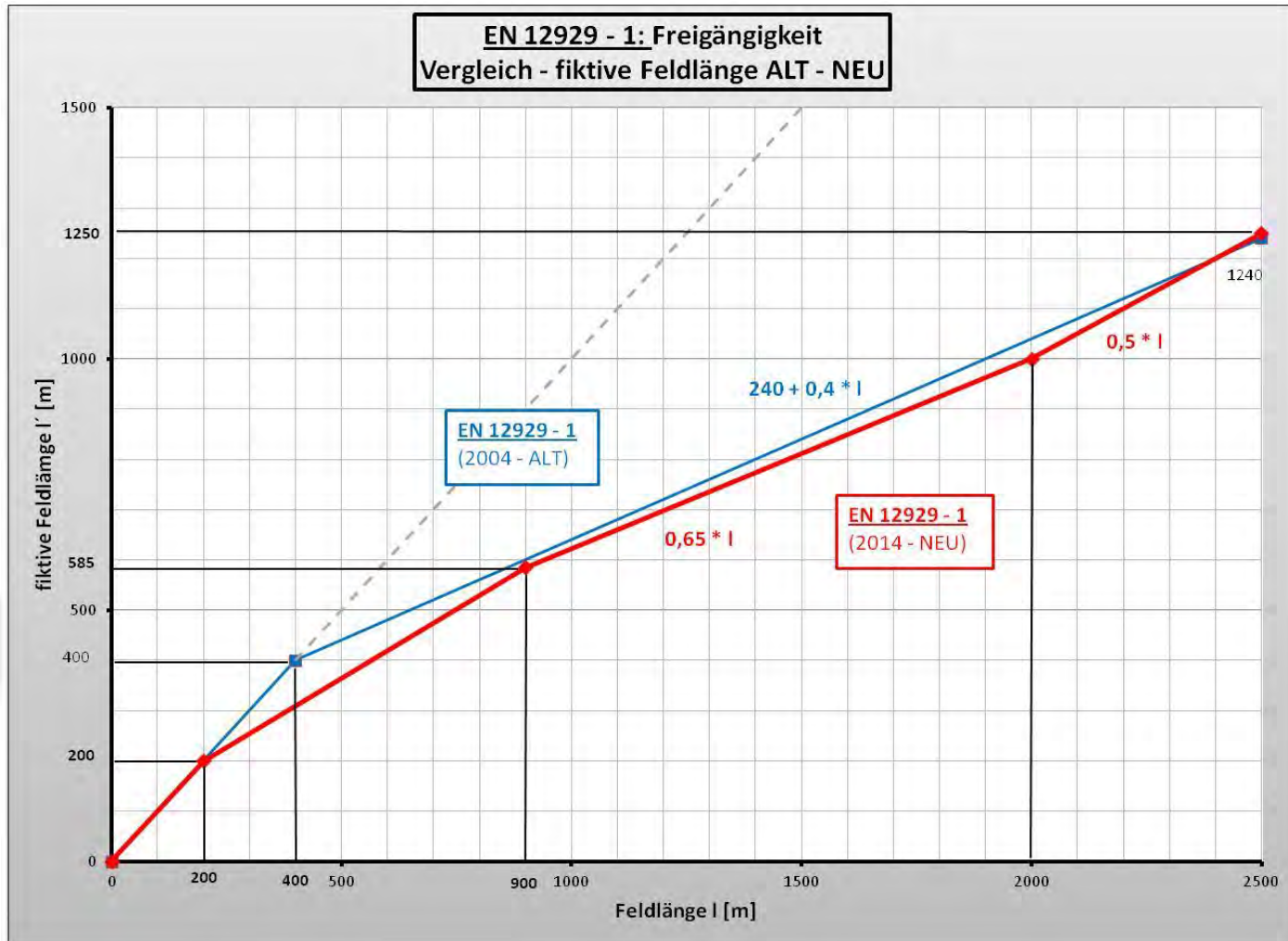
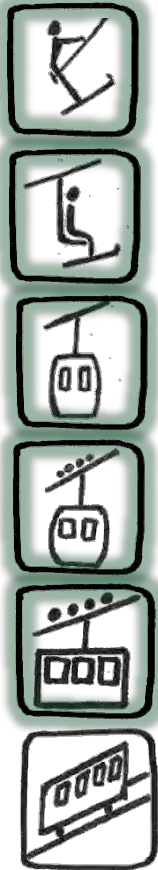



FprEN12929-1 Allgemeine Bestimmungen / general requirements

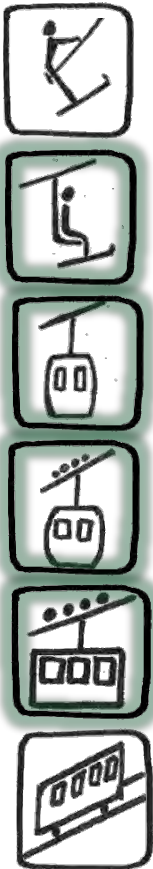

Titel	Änderung	Auswirkung
8 Größter zulässiger Bodenabstand	8.2 Für Kabinen 60 m statt 30 m	Verbesserung
	8.2.3 Für Kabinen keine Beschränkung Bodenabstand, wenn Bergung längs des Seiles	Verbesserung
	8.3.2 Max. Bodenabstände Sessel Verständlichere Formulierung und Vergrößerung der zul. Länge bei Bodenabstand über 15 m 200m bei Bahnlänge < 1000 m 20 % der Bahnlänge > 1000 m	Verbesserung

Title	Change	Effect
8 Maximum permissible running height above ground	8.2 For cabins 60 m instead of 30 m	Improvement
	8.2.3 For cabins No restriction of the running height above ground in case of evacuation along the rope	Improvement
	8.3.2 Max. running height above ground for chairs Clearer phrasing and increase of the permissible length for height above ground of more than 15 m 200 m for installation length < 1,000 m 20 % of installation length > 1,000 m	Improvement



FprEN12929-1 Allgemeine Bestimmungen / general requirements

Titel	Änderung	Auswirkung
9.2.3 Größte Fahrgeschwindigkeiten	3-S: 8,0 m/s statt 7,0 m/s 2-S: 7,0 m/s statt 6,0 m/s	Verbesserung
	Pendelbahn, 2 Tragseile: Begleitet, Stützenüberfahrt 12,0 m/s statt 10,0m/s Unbegleitet, freies Seilfeld 12,0 m/s statt 7,0m/s Unbegleitet, Stützenüberfahrt 8,0 m/s statt 7,0m/s	
	Pendelbahn, 1 Tragseil: Unbegleitet, freies Seilfeld 12,0 m/s statt 7,0m/s Unbegleitet, Stützenüberfahrt 7,0 m/s statt 6,0m/s	
	Standseilbahn: 14,0 m/s statt 12,0 m/s	
9.2.3 Maximum running speeds	3S: 8.0 m/s instead of 7.0 m/s 2S: 7.0 m/s instead of 6.0 m/s	Improvement
	Aerial ropeway, 2 track ropes: accompanied, above line support structures 12,0 m/s (10,0) Unaccompanied, away from rope spans 12,0 m/s (7,0) Unaccompanied, above line support structures 8,0 m/s (7,0)	
	Aerial ropeway, 1 track rope: Unaccompanied, away from rope spans 12,0 m/s (7,0) Unaccompanied, above line support structures 7,0 m/s (6,0)	
	Funicular railways 14,0 m/s instead of 12,0 m/s	

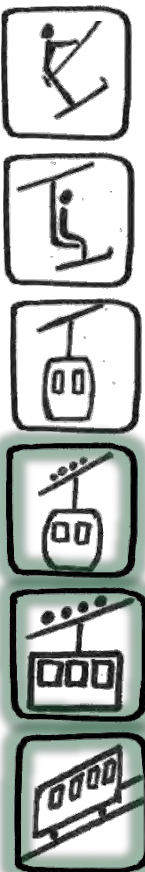



FprEN12930
Berechnungen / calculation

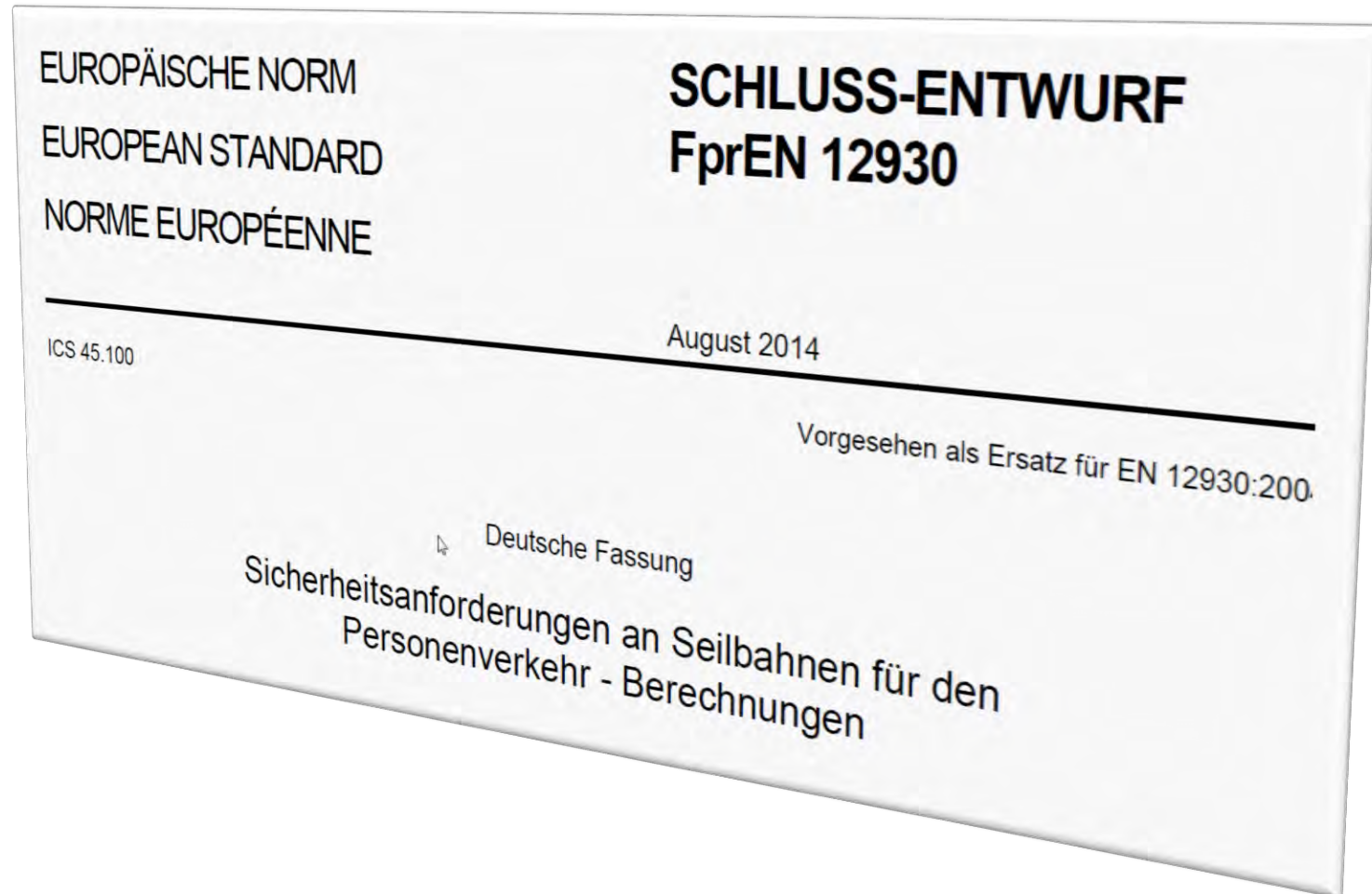



Titel	Änderung	Auswirkung
6.5 Einwirkungen (Kräfte)	6.5.4.c Änderung Reduktionsbeiwert β ausser Betrieb 1,00 bei $L^* = 0$ m 0,65 bei $L^* = 600$ m 0,50 bei $L^* \geq 2000$ m	Merkliche Verbesserung für Windkräfte
	6.5.5.3 Angabe der Eislast (Gewicht)	

Title	Change	Effect
6.5 Actions (forces)	6.5.4c Change of the reduction coefficient β out of operation 1.00 for $L^* = 0$ m 0.65 for $L^* = 600$ m 0.50 for $L^* \geq 2,000$ m	Noticeable improvement for wind forces
	6.5.5.3 Indication of ice load (weight)	



FprEN12930 Berechnungen / calculation

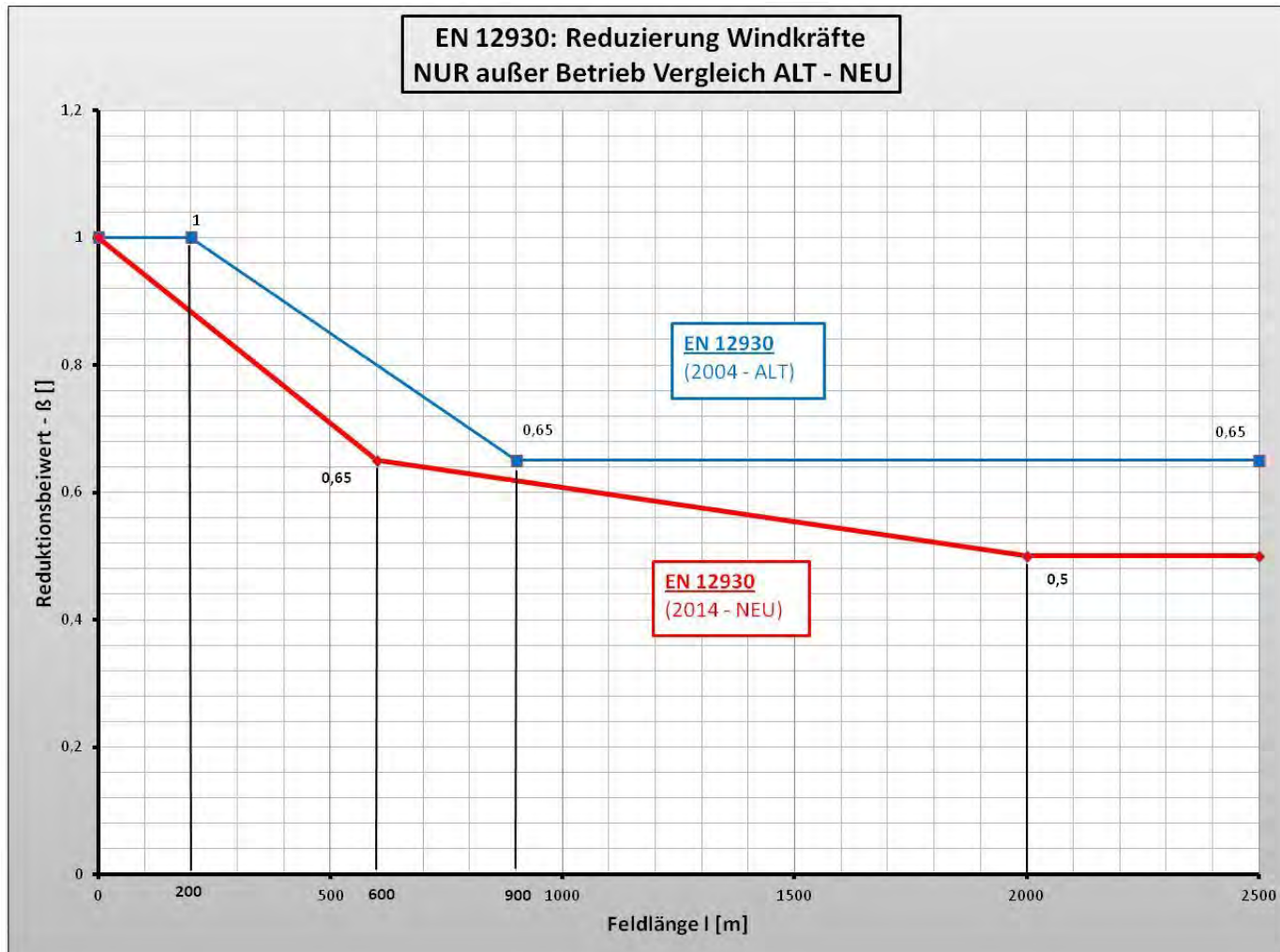



Zugseile, Förderseile / Carrying rope, carrying-hauling rope

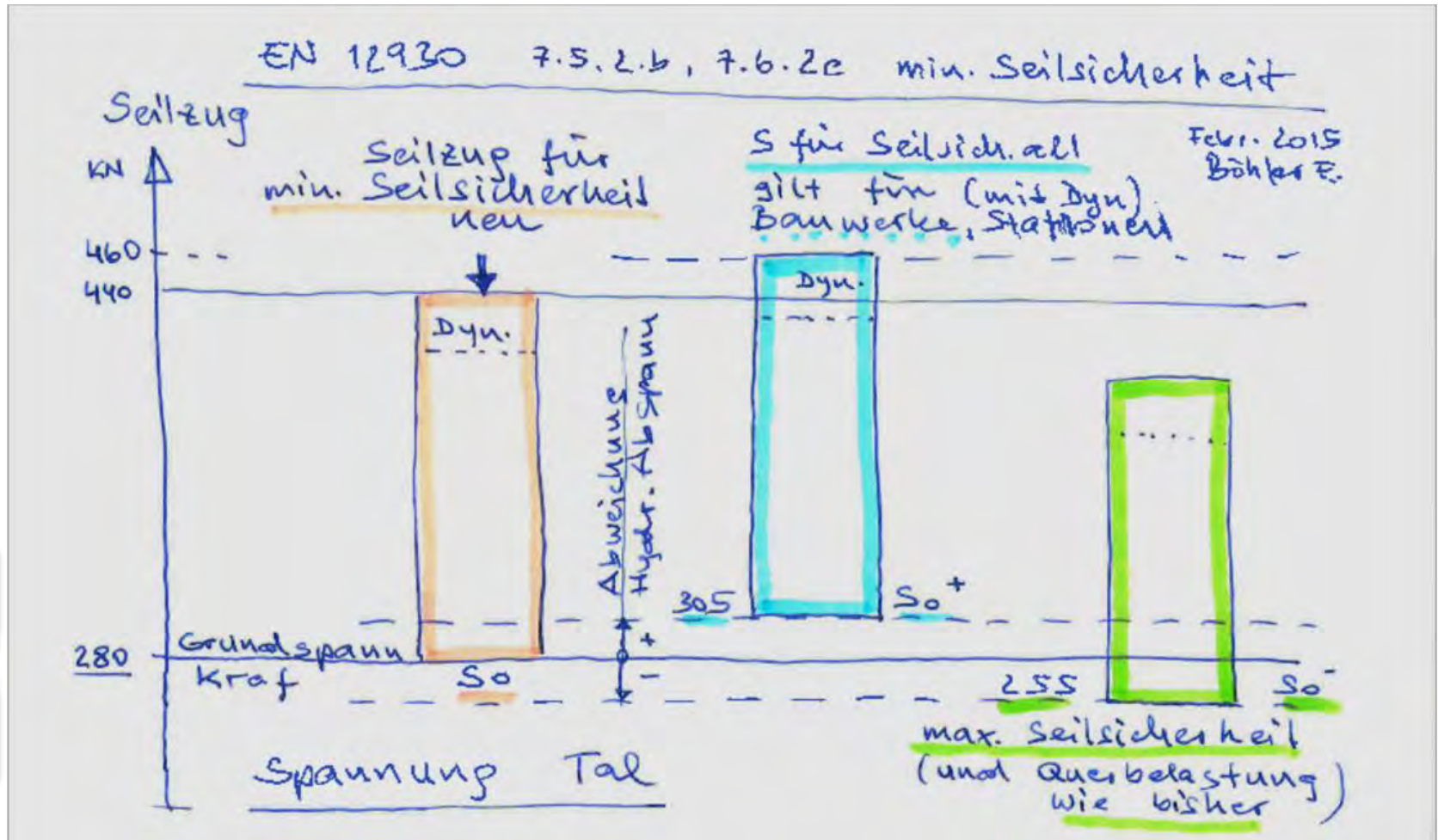
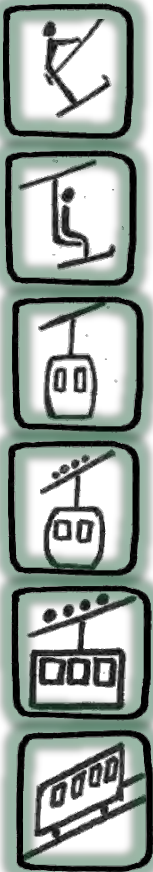



Zugseile, Förderseile / Carrying rope, carrying-hauling rope

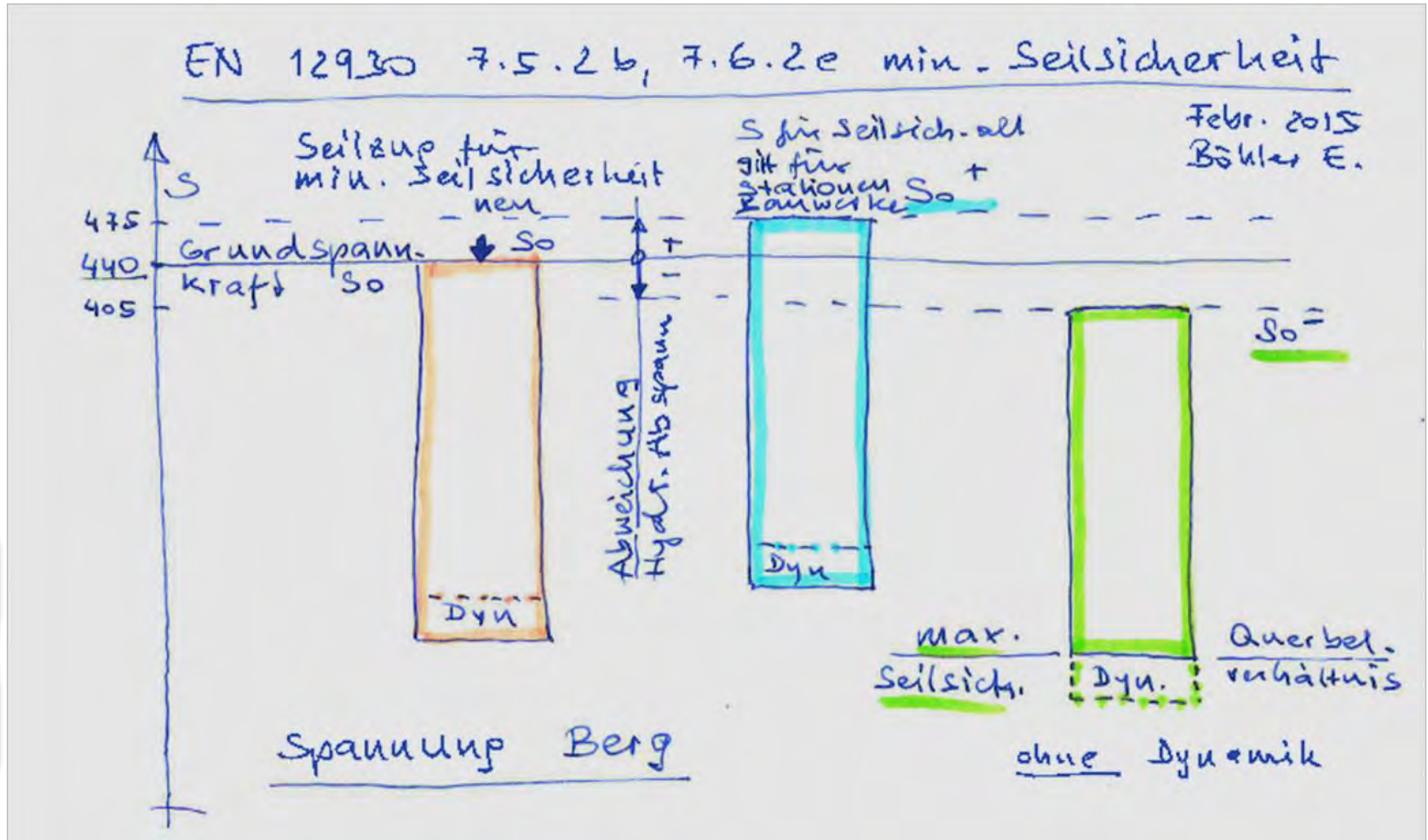
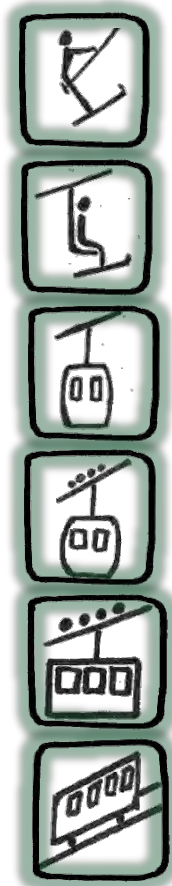



FprEN13107
Bauwerke / Civil engineering works

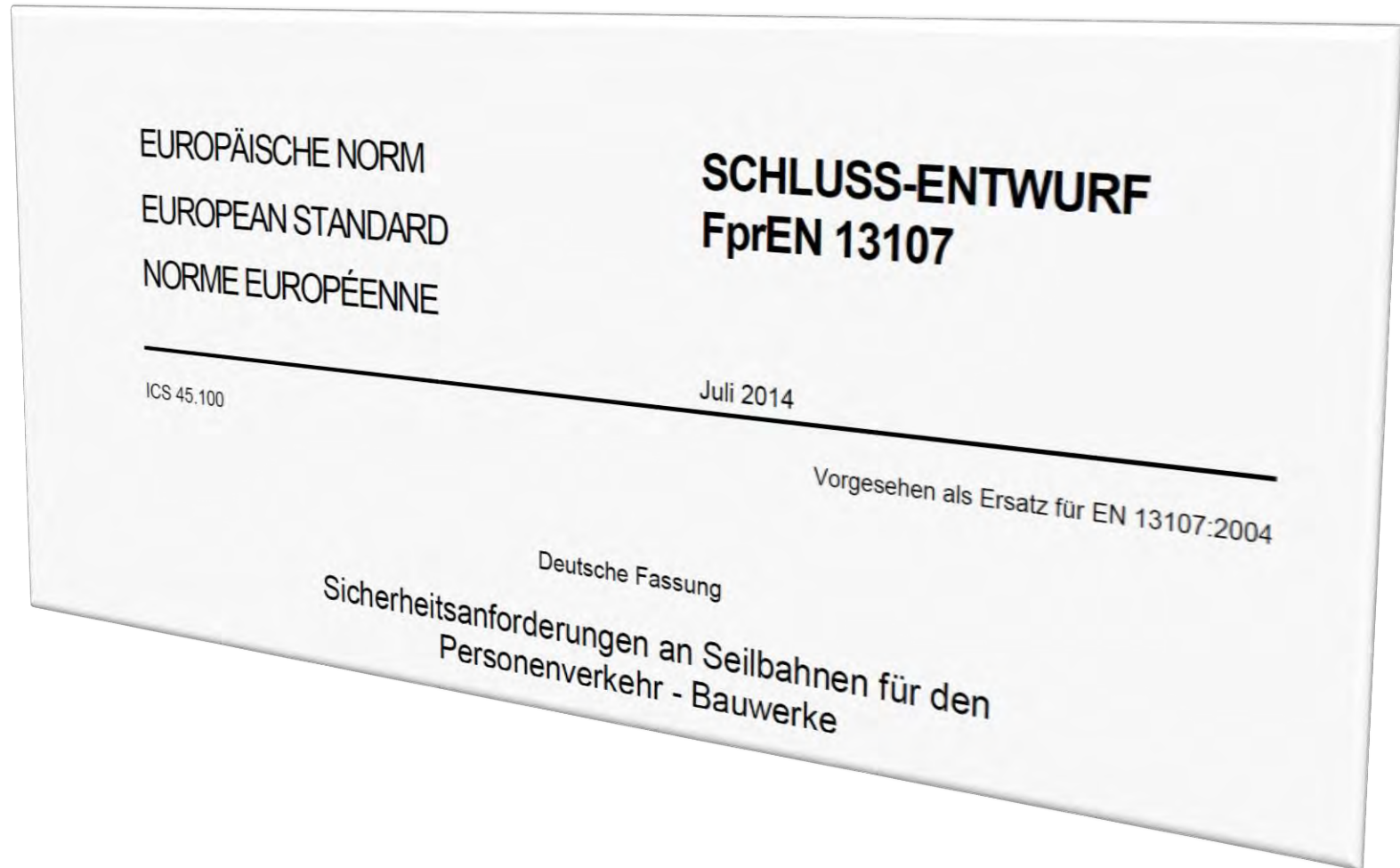



Titel	Änderung	Auswirkung
11.2.1.1 Nachweis des statischen Gleichgewichtes (EQU)	Ausmittigkeit der Sohldruckresultierenden <u>in Betrieb</u> in der 1. Kernweite <u>ohne</u> Umwelteinwirkungen	Weniger Beton, wenn IB massgebend

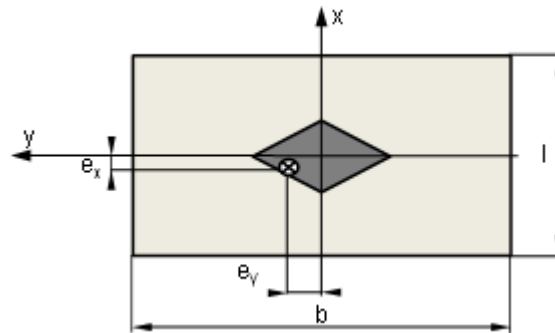

Title	Change	Effect
11.2.1.1 Verification of the static equilibrium (EQU)	Eccentricity of the resulting bearing pressure in the first core width for track conditions <u>in operation</u> <u>without</u> environmental actions	Less concrete if the conditions in operation are relevant



Titel

Änderung

Auswirkung

11.2.1.1 Nachweis des statischen Gleichgewichtes (EQU)

Minimal gedrückte Sohlfläche für aussergewöhnliche Einwirkungen: 30 % (früher 50 %)

Weniger Beton, wenn eine aussergewöhnliche Einwirkung massgebend ist

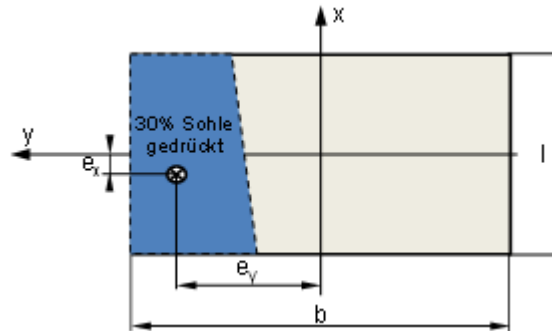

Title

Change

Effect

11.2.1.1 Verification of the static equilibrium (EQU)

Minimal compressed bearing surface for accidental actions: 30 % (instead of 50 %)

Less concrete if an accidental action is relevant



Titel	Änderung	Auswirkung
11.2.1.1 Nachweis des statischen Gleichgewichtes (EQU)	Stationen in Betrieb: 100 % (früher 60 %) Sohlfläche gedrückt (jedoch Nominalwert des Seilzuges und ohne Umwelteinwirkungen)	Wahrscheinlich mehr Beton

Title	Change	Effect
11.2.1.1 Verification of the static equilibrium (EQU)	Stations in operation: 100 % (instead of 60 %) of the relevant surface is subjected to compressive stresses (but nominal value of rope tension and without environmental actions)	Probably more concrete



FprEN12929-1
FprEN12929-2

EUROPÄISCHE NORM
EUROPEAN STANDARD
NORME EUROPÉENNE

SCHLUSS-ENTWURF
FprEN 12929-1

ICS 45.100

Juli 2014

Vorgesehen als Ersatz für EN 12929-1:2004

EUROPÄISCHE NORM
EUROPEAN STANDARD
NORME EUROPÉENNE

SCHLUSS-ENTWURF
FprEN 12929-2

ICS 45.100

Juli 2014

Vorgesehen als Ersatz für EN 12929-2:2004

Deutsche Fassung

Sicherheitsanforderungen an Seilbahnen für den
Personenverkehr - Allgemeine Bestimmungen - Teil 2:
Ergänzende Anforderungen an Zweiseil - Pendelbahnen ohne
Trauseilbremse

ing
Seilbahnen für den
Bestimmungen - Teil 1:
lle Anlagen



FprEN12929-1 Allgemeine Bestimmungen / general requirements

Titel	Änderung	Auswirkung
6.3.5 Anprallen an Streckenbauwerke	Bei Störfällen bei Pendelbahnen: 3.5m/s anstatt 3.0m/s	Kürzere Gehänge

Title	Change	Effect
6.3.5 Impact against a line structure	In the case of faults on reversible aerial ropeways: 3.5m/s instead of 3.0m/s	Shorter hanger





FprEN12929-2 Pendelbahnen ohne Tragseilbremse / Aerial ropeways without carrier track brakes

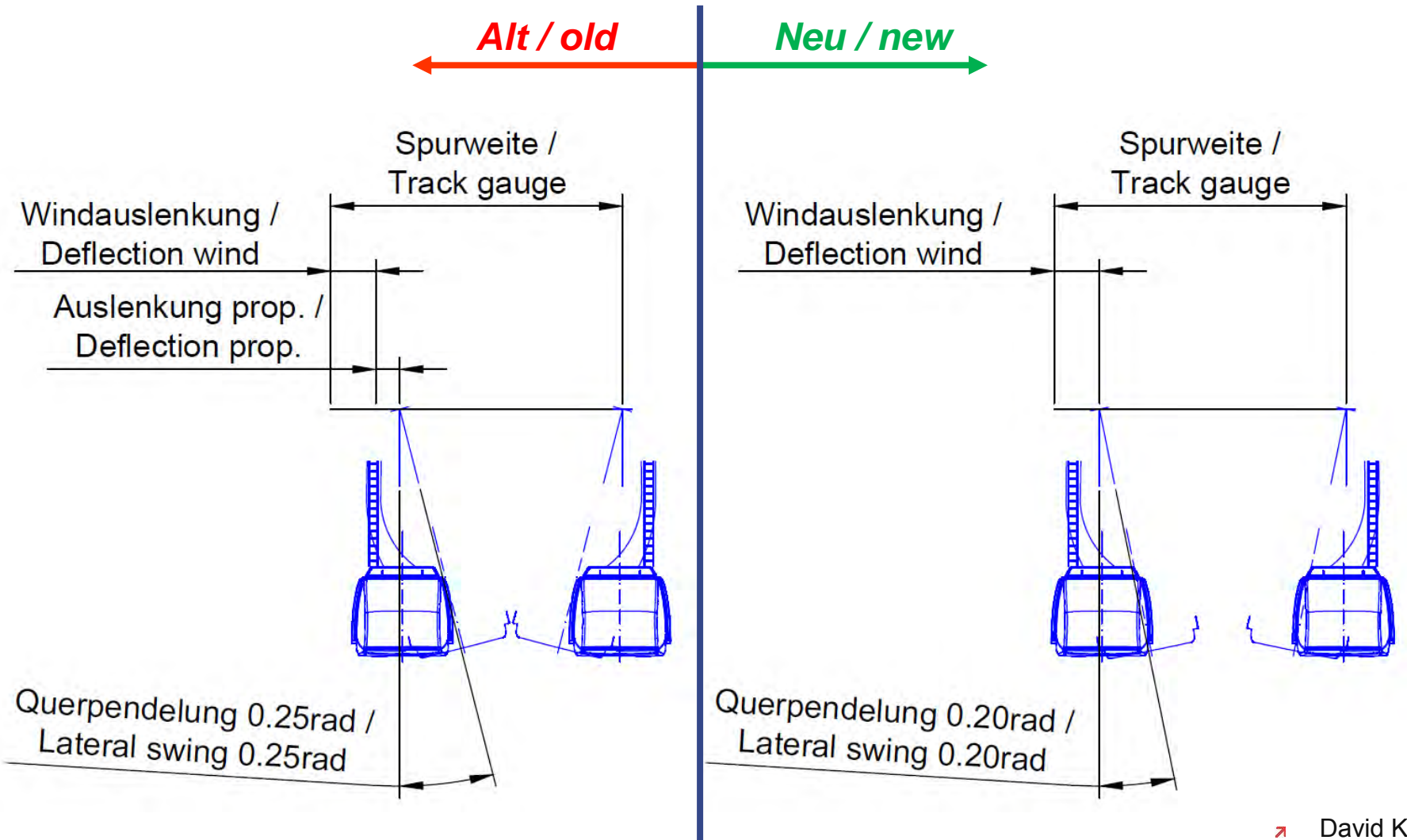

➤ David Käser



FprEN12929-2 Pendelbahnen ohne Tragseilbremse / Aerial ropeways without carrier track brakes

Bisher / **Until now:** $v \leq 20$

Neu / **New:** $v \leq 20$ im Spleiss / **in splice**

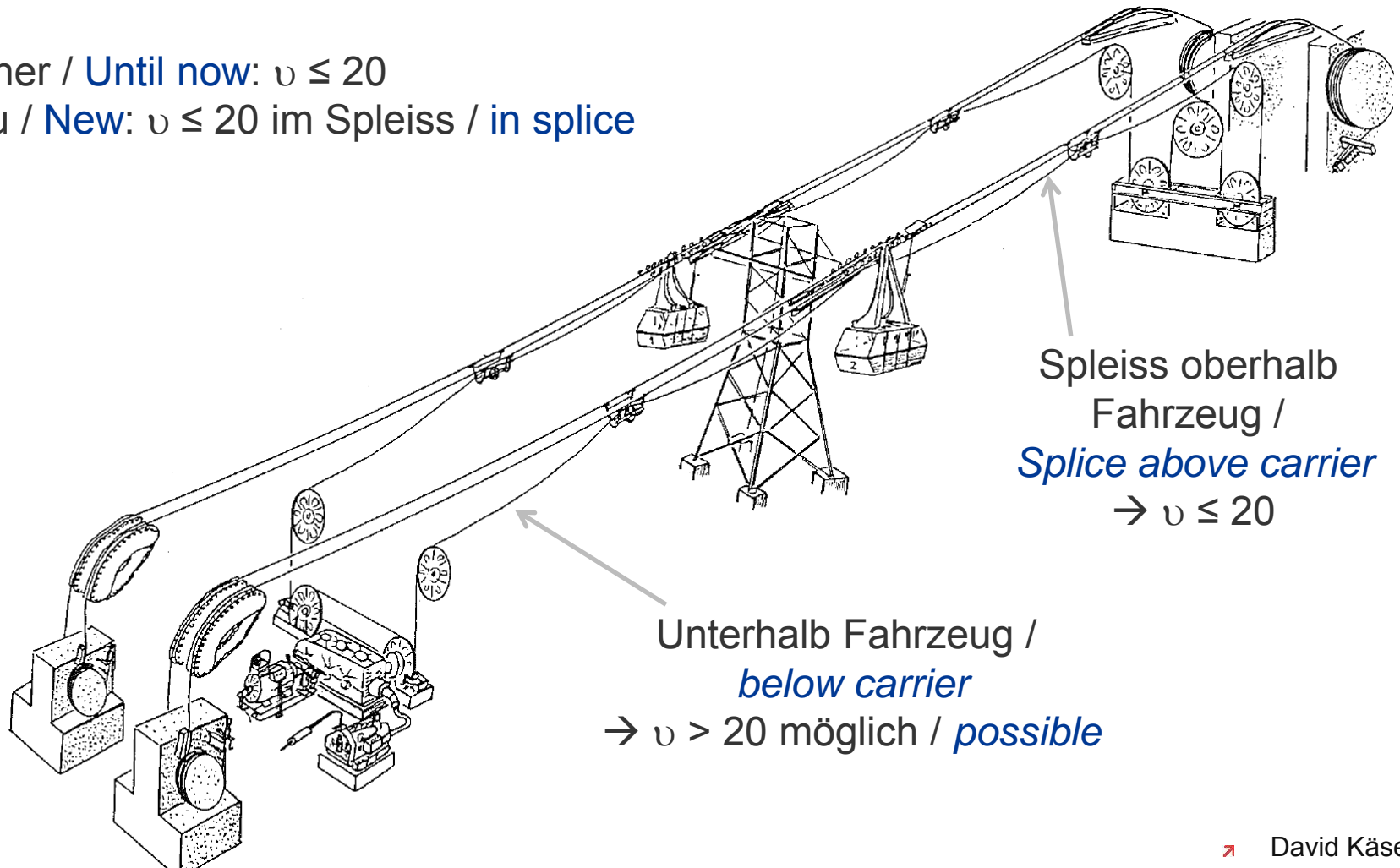



**«Egal wie weit der Weg ist,
man muss den ersten Schritt tun»**