

# OITAF

## Seminar 2015

# Feedback on recent accidents and follow-up

Gaëtan RIOULT – Head of Ropeways Department

- 1) Presentation goals
- 2) Falls of passengers from chairlift seats
- 3) Falls or blockings of vehicles of monocable aerial ropeways
- 4) Conclusion



**1) Presentation goals**

- 2) Falls of passengers from chairlift seats
- 3) Falls or blockings of vehicles of monocable aerial ropeways
- 4) Conclusion

# 1. Presentation goals

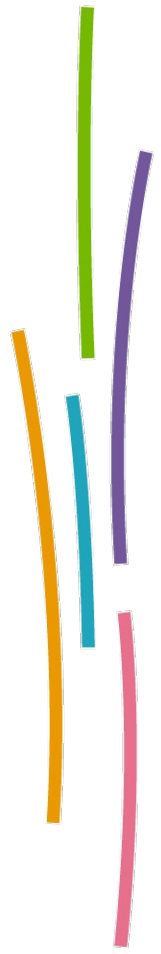

#### 1) Presentation goals

- 2) Falls of passengers from chairlift seats
- 3) Falls or blockings of vehicles of monocable aerial ropeways
- 4) Conclusion

# Why speak about experience feedback ?

## Why speak about incidents or accidents in a seminar about innovation?

- Promotion of the safety passes by an organization of the memory of the past events.
- Safety = compromise between socially-acceptable accidentology (society : users, opinion, media, magistrates) for a given standard of service and bearable investment by the economic players of the work community to handle this accidentology.
- = > Only dialogue allows to define the good compromise.
- This presentation aims at bringing reflection elements to enrich this dialogue and guide the innovation...



- 1) Presentation goals
- 2) Falls of passengers from chairlift seats**
- 3) Falls or blockings of vehicles of monocable aerial ropeways
- 4) Conclusion

# 2.

## Falls of passengers from chairlift seats



# Context

- Several significant events occurred in France between 2011 and 2015
  - Several children's falls mediatized in February and March, 2012
  - Death of a passenger in December, 2012 following a fall from a chair
  - Death in Italy (on the frontier with France) of a passenger in March, 2013
  - New falls, particularly children, between January and April, 2013
- The profession is strongly questioned concerning the risk control of fall on chairlifts.

# French action plan

- Organization in 2013 by the STRMTG of a reflection with the work community = >  
Day of exchanges in June, 2013 leading to the definition of an action plan :
  - Organizational measures (implementation in progress) :  
Communication towards the passengers, improvement of the cooperation between operators and ski schools...  
<https://www.youtube.com/user/FilmsDSF>
  - Definition to come from a coherent frame of equipment of the existing chairlifts with additional devices (equipment according to a multicriteria analysis, according to a schedule to be individually defined).
- This action passes by a preliminary guidance analysis of the functions expected from the additional devices and their limits.

# Preliminary reflections concerning the additional devices

Based on the study of falls observed in France since about 10 years, three problems to be considered, in decreasing order of priority:

- 1) Detection of bad boardings
- 2) Submarining under the safety bar
- 3) Opening in advance of the safety bar



# A) Operating assistance systems

- Their object is to help the operating staff to detect the abnormal situations (problems of loading or unloading, abnormal positions on or under chairs...),
- or to avoid situations with potential risks (departure with opened safety bar).
- In France, companies experimented detection systems of departure of seats with opened safety bar.
- But the development of such systems goes slowly.

# A) Operating assistance systems

- Questions that arise :
  - Safety level of these systems and interfaces with operators (question of the loss of vigilance of the operators in connection with the reliable level expected from the system)
  - Does the detection of an abnormal situation have to lead to stop the chairlift or to an alarm for the staff ?  
It's not the same thing to detect an opened safety bar and a person suspended under the chair...
  - Does detection allow the operators to have a relevant action with regard to the presented situation?  
For example, the stop further to the detection is made while a person is already suspended under the seat, with an important height. What should the operator do ?

## B) Additional devices on chairs

They aim at improving the use of chairs by the passengers, with 3 types of function :

- **Space reduction under the safety bar**

The goal of this function is to fill the present space under the safety bar to minimize the risk of fall (risk of "submarining")

- **Handling of safety bar** (automatic or semiautomatic)

The purpose is to master the moment of operation of the safety bar so as to avoid too-late closings or anticipated openings.

- **Blocking of safety bar during the ride**

The aim is to forbid the opening of the safety bar during the ride so as to avoid a possible imprudence of the passengers.

- 1) Presentation goals
- 2) Falls of passengers from chairlift seats
- 3) Falls or blockings of vehicles of monicable aerial ropeways
- 4) Conclusion

# Reminder of measures in standard EN 13796-1

## Chair design

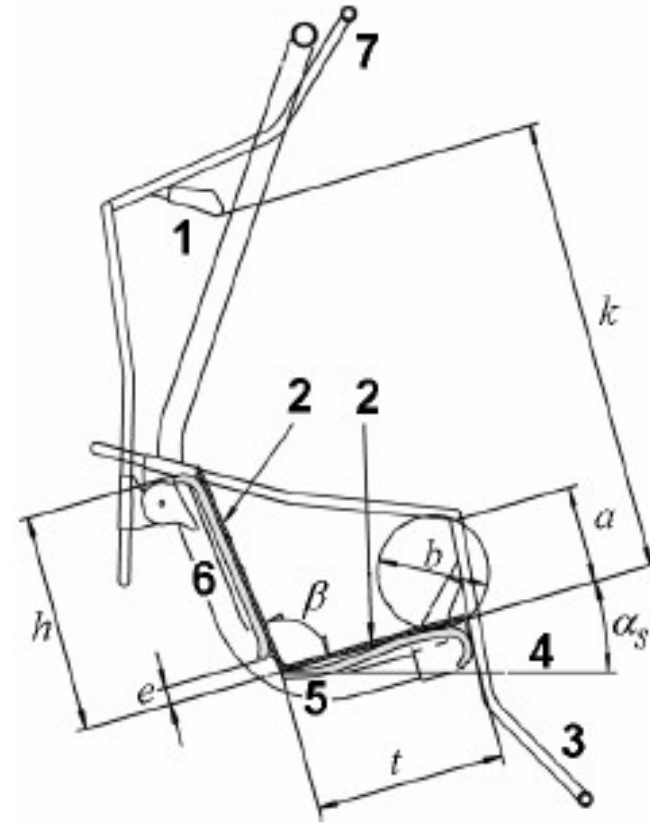

- $a \geq 0,2 \text{ m}$
- $0,45 \text{ m} \leq t \leq 0,5 \text{ m}$
- $b \leq 0,25 \text{ m}$
- $h \geq 0,35 \text{ m}$
- $e \leq 0,15 \text{ m}$
- $k \leq 0,85 \text{ m}$
- $\beta \geq \pi/2 \text{ rad}$
- whatever the load case:  $\alpha_s \geq 0 \text{ rad}$

### Key

- 1 Operating handle of the safety bar in open position
- 2 Space envelope
- 3 Safety bar in closed position
- 4 Reference horizontal line
- 5 Seat
- 6 Back
- 7 Safety bar in the open position



## B) Additional devices on chairs

- **Reduction of the space** under the safety bar

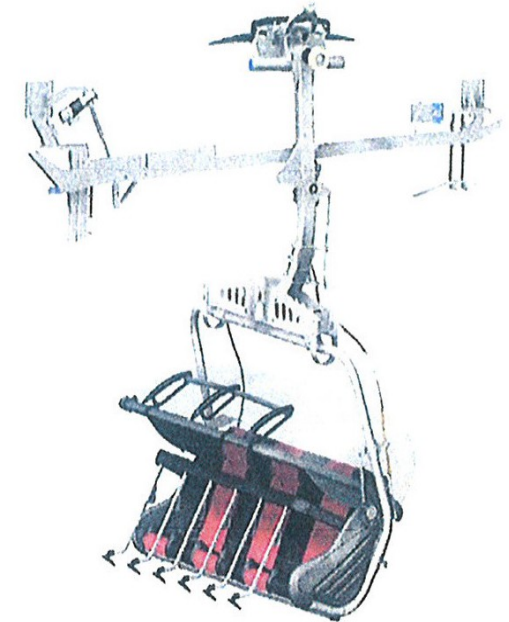
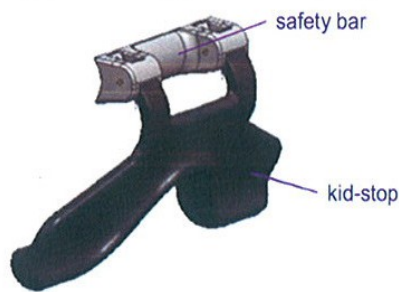

- **Handling of safety bar**
- **Blocking of safety bar** during the ride



## B) Additional devices on chairs

- Numerous debates on the efficiency of these devices or the legal responsibilities bound to the equipment (or the absence of equipment) on the chairs
- The problem must be addressed by giving to the profession the most objective possible data on falls of passengers and devices developed to reduce the risk :
  - Elaboration of statistics on the falls of height (with or without injured people)
  - For every already-mentioned function, typology of existing additional devices and brief analysis establishing targets, expected uses, advantages and limits of the various devices, even the new risks possibly associated.

Function	Description of the system	Target		Expected uses				Avantages	Limits	Associated or led risks
		Children	Adults	Loading	Departure	Line	Arrival			

- 1) Presentation goals
- 2) Falls of passengers from chairlift seats
- 3) Falls or blockings of vehicles of monicable aerial ropeways
- 4) Conclusion

## Exemple : Fonction « réduction de l'espace sous la barre de sécurité »

Function	Description of the system	Target		Expected uses					Avantages	Limits	Associated or led risks
		Children	Adults	Loading	Departure	Line	Arrival	Unloading			
Réduction des vides sous garde-corps par ajout d'une « palette » articulée	Dispositif individuel ajouté sur le garde-corps sur tout ou partie des places de siège destiné à réduire l'espace existant entre le garde-corps et l'assise.	X	X		X	X	X		Réduit l'espace entre le garde-corps et l'assise.	Ne protège pas tous les passagers si toutes les places ne sont pas équipées. Possibilité physique de s'asseoir entre deux palettes. Possibilité de relever le garde-corps à tout moment	Mauvais embarquement suite à difficulté de positionnement sur l'assise en raison de la multiplicité des tubes et repose-pieds.
Réduction des vides sous garde-corps par un montant s'insérant entre les jambes (repose pieds ou autre).	Dispositif individuel ajouté sur le garde-corps sur tout ou partie des places de siège destiné à réduire l'espace existant entre le garde-corps et l'assise.	X	X		X	X	X		Empêche la glissade sous le garde-corps	Ne protège pas tous les passagers si toutes les places ne sont pas équipées. Possibilité physique de s'asseoir entre deux montants. Possibilité de relever le garde-corps à tout moment	Mauvais embarquement suite à difficulté de positionnement sur l'assise en raison de la multiplicité des tubes et repose-pieds. Coincements ou heurts liés à la multiplicité des montants



# Continuing the development of additional devices

## 1) Detection of bad loadings

Continuation of the development of detection systems, by going towards shape recognition

Work on the organizational aspects of loading supervision

Question of the high backs on seats preventing the operators from seeing the passengers on the seats when they leave ?

## 2) Submarining under the safety bar

The equipment of several places on chairs does not a priori generate particular problems (time will tell) but vigilance on the conciliation of various uses : preserving a central zone without equipment for certain seats or with a compatible equipment with transport of handicapped skiers

## 3) Anticipated opening of the safety bar

Solution of blocking at departure and releasing on arrival : doable on new installations but heavy to implement and not fully assessed for the existing installations.

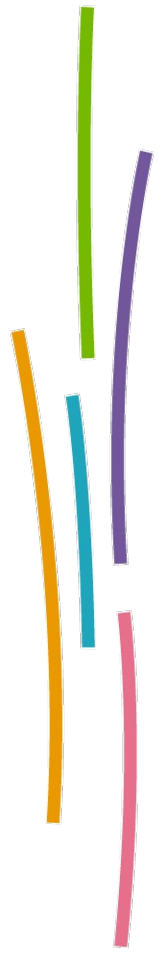



- 1) Presentation goals
- 2) Falls of passengers from chairlift seats
- 3) Falls or blockings of vehicles of monocable aerial ropeways**
- 4) Conclusion

# 3.

## Falls or blockings of vehicles of monocable aerial ropeways



# Context

- About ten events of the type « blocking and/or fall of vehicles » of monocable aerial ropeways during their passage on towers occurred in France during the last 10 years.
- The causes of these events are diverse and possibly multiple : misalignment of roller batteries, deterioration or blocking of rollers, blocking with safety line, excessive balance of carriers...
- 3 important incidents in France these last years
  - ✓ Falls of several cabins during annual tests (2011)
  - ✓ Fall of a cabin and its passengers during operation (2013)
  - ✓ Blocking of a chair and fall of its passenger during operation (2014)

- 1) Presentation goals
- 2) Falls of passengers from chairlift seats
- 3) Falls or blockings of vehicles of monicable aerial ropeways**
- 4) Conclusion

# 3 important incidents in France these last years : Falls of several cabins during annual tests (2011)



# 3 important incidents in France these last years : Falls of several cabins during annual tests (2011)

## Circumstances :

- Fall of 5 cabins from a gondola lift during tests outside operating.
- These falls follow from cabins getting stuck to a line support structure. The first blocking was due to the sticking of the door opening cable to a sheave train fixing bolt.
- The STRMTG concluded that 3 elements together could explain the incident :
  - A too long door opening cable
  - A cabin located at the sheave train entrance
  - A longitudinal swinging due to a stopping

# 3 important incidents in France these last years : Falls of several cabins during annual tests (2011)

## Measures taken by the STRMTG

- Before winter 2011/2012 campaign of controls on the whole french stock of cabins equipped with door handling control to verify the absence of any unusual geometry of the door opening cable
- Setting-up of a think-tank for longitudinal swinging of the vehicules  
(several test campaigns done but no conclusion yet)

- 1) Presentation goals
- 2) Falls of passengers from chairlift seats
- 3) Falls or blockings of vehicles of monocable aerial ropeways**
- 4) Conclusion

# 3 important incidents in France these last years : Fall of a cabin and its passengers during operation (2013)

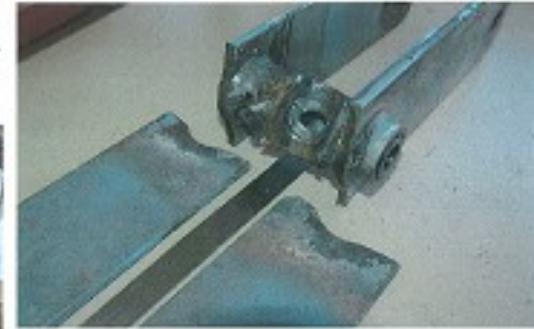
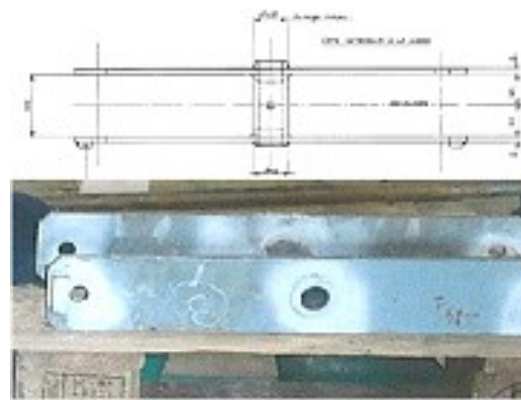

# 3 important incidents in France these last years : Fall of a cabin and its passengers during operation (2013)

## Circumstances :

- Breaking of two rollers bogie frame on a sheave train support leading to the ripping of a carrier grip at the passing on the sheave train.
- Analysis shows a fatigue phenomenon on horizontal dynamic stress.

## Measure already taken by the STRMTG :

- Visual check of all bogies of 2 sheave trains of the same kind (inventory by an independant inspector in 2013, then annually per operator).
- Replacement of bogies of 2 by new designed bogies before the end of 2018

- 1) Presentation goals
- 2) Falls of passengers from chairlift seats
- 3) Falls or blockings of vehicles of monocable aerial ropeways**
- 4) Conclusion

## 3 important incidents in France these last years : Blocking of a chair and fall of its passenger during operation (2014)





# 3 important incidents in France these last years : Blocking of a chair and fall of its passenger during operation (2014)

## Circumstances :

- In this case, two causes can lead to the blocking :
  - Guide in the clearance envelope of the vehicle
  - Vehicle with an abnormal behavior (oscillations) at the passage of the guide
- The numerous realized investigations did not allow any conclusion. Main hypothesis probably retained : misadjustment of the guide

## Measures :

- No generic measure but still questions concerning the longitudinal oscillations of vehicles.

# Existence of such incidents outside France

- The STRMTG questioned his partners during the ITTAB (2014) to know their experience feedback concerning the occurrence of such scenarios (blocking / fall)
- It turns out that several events of this type also occurred in various countries (break of roller batteries, strong wind, fall of tree) during the last 10 years (Austria, Canada, China, Slovenia...)



- 1) Presentation goals
- 2) Falls of passengers from chairlift seats
- 3) Falls or blockings of vehicles of monocable aerial ropeways**
- 4) Conclusion

# Proposal of thinking directions for future improvements (1/2)

In a reduced window of time, it appears possible to reproduce blockings or falls of vehicles during their passage at towers for a monocable aerial ropeway.

Our systems are not able to detect some scenarios of major failure and may even allow them to happen again quickly.

Wish on the french side to organize, in contact with the manufacturers and the operators, the study and testing of technical devices to detect any blocking of a cabin or a chair during their passage at a tower.



- 1) Presentation goals
- 2) Falls of passengers from chairlift seats
- 3) Falls or blockings of vehicles of monocable aerial ropeways**
- 4) Conclusion

# Proposal of thinking directions for future improvements (2/2)

## **Taking into account the horizontal dynamic stresses for the calculation of the roller batteries**

Implementation of constraint measures on different sheave train of the stock in use

Definition of a method of justification to the sheave train fatigue with consideration of dynamic lateral efforts

Action with the CEN/TC242 to modify the norm according to the results of this process

- 1) Presentation goals
- 2) Falls of passengers from chairlift seats
- 3) Falls or blockings of vehicles of monocable aerial ropeways
- 4) Conclusion**

# 4. Conclusion



- A lot of commitment of the various partners of the profession to increase, again and again, the safety of ropeways.
- Thankless and difficult work of improvement, a lot of energy and money being dedicated to it for not necessarily visible results considering the low level of accidentology
- Nevertheless, the profession is expected on its capacity to learn of past events and to progress
- This presentation proposes directions for reflection to improve two types of situations that can't be accepted today

# END

